



BRAKES

HIGH PERFORMANCE
SINTERED
BRAKE PADS

Mastercatalogue N°10

Plaquettes
de frein

Motorcycles,
ATV, Scooters
Brake pads

Brake pads



www.cl-brakes.com

Division Freins

Depuis le 1^{er} avril 2008, la division Freins CLBrakes appartient au groupe Faiveley Transport. Créé en 1919, il est le principal acteur des systèmes ferroviaires embarqués avec plus de 5000 salariés et plus de 30 sites dans le monde. Désormais appelé « Faiveley Transport Gennevilliers » la division Freins conserve la fabrication de ses plaquettes en métal fritté sur le site historique de Carbone Lorraine, bénéficiant ainsi d'un savoir faire commun en Recherche et Développement. De même, notre expérience tant en aéronautique qu'en ferroviaire profite à l'amélioration continue de nos matériaux pour l'automobile, la moto ou encore le vélo.

Since the first of april 2008, Faiveley Transport took of CLBrakes brake pads division which new name is Faiveley Transport Gennevilliers. Created in 1919, the company is the main actor in integrated on-board railway systems with more than 5.000 employees and more than 30 sites over the world. Sintered metal brake pads are still manufactured in the historical site of Carbone Lorraine and benefit from a common know-how in R&D. Our experience in aeronautic and railway is used to develop materials for race cars, motorcycles and mountain bikes.

Brake division

Seit dem 01.april 2008, hat Faiveley Transport die Produktschiene Bremsbeläge mit dem neuen Namen Faiveley Transport Gennevilliers übernommen. Gegründet 1919 war die Firma CLBrakes einer der Hauptakteure für die Ausstattung von Bahnen mit mehr als 5000 Angestellten und mehr als 30 Vertretungen in der ganzen Welt. Gesinterte Metallbremssysteme werden noch heute durch Carbone Lorraine produziert. CLBrakes profitiert noch heute von dem bekannten Know-how aus dem Bahnverkehr. Diese Erfahrungen in der Luftfahrt und dem Bahnverkehr wurde genutzt, um Materialien für Rennwagen, Motorräder und Mountain Bikes herzustellen.

La Division Freni CLBrakes, a partire dal 01 aprile 2008, è stata acquisita dalla società Faiveley Transport ed è divenuta Faiveley Transport Gennevilliers. Società nata nel 1919 e leader nei sistemi ferroviari di bordo integrati, Faiveley conta più di 5000 dipendenti e più di 30 sedi nel mondo. Le pastiglie freno in materiale sinterizzato, fabbricate ancora nella sede storica Carbone Lorraine, vengono progettate e sviluppate come in passato a nostra cura ma beneficiano oggi di maggiori supporti tecnici grazie all'unione delle competenze in ambito aeronautico e ferroviario, favorendo così anche il settore dell'automobile, la moto e la bicicletta.

Desde el primero de abril de 2008, Faiveley Transport acoge de CLBrakes división pastillas de freno, con el nuevo nombre Faiveley Transport Gennevilliers. Creada en 1919, es una de las más importantes del sector con más de 5000 empleados y más de 30 sitios en el mundo. El metal sinterizado de las pastillas está fabricado en nuestra histórica fábrica de Carbone Lorraine y es un beneficio para nuestro departamento de I+D. Nuestra experiencia en la aeronáutica y los trenes es usada para desarrollar materiales para coches de competición, motocicletas y mountain bikes.



Mastercatalogue N°10



Sommaire

Contents Indice Contenido

Compétition

Racing
Wettbewerb
Competizioni
Actividades Racing 2-3

Recherche & Développement

Research & Development
Forschung & Entwicklung
Ricerca & Sviluppo
Investigación y Desarrollo 4

La technologie métal fritté

Sintered metal technology
Sintermetall-Technologie
Tecnologia Materiale Sinterizzato
Tecnología Metal Sinterizado 5

La gamme de plaquettes

Brake pads range
Produkreihe
Gamma Prodotti
Gama de pastillas 6-10

Assurance Qualité

Quality Insurance
Qualitätskontrolle
Garanzia di Qualità
Aseguramiento de calidad 11

Matériel promotionnel

Promotional material
Werbematerial
Materiale Promozionale
Material Promocional 12

Applications Route

Street applications / Straße
Applicazioni Stradali / Aplicaciones carretera 13-31
Etriers / Calipers / Steibügle
Pize freno / Pinza de freno 32

Applications Racing

Racing applications
Applicazioni Racing
Aplicaciones Racing 33-35

Applications Tout-Terrain

Off-Road applications
Applicazioni Fuoristrada
Aplicaciones todo-terreno 36-42

Applications QUAD

ATV applications
Applicazioni ATV
Aplicaciones ATV 43-47

Applications Scooter

Scooter applications
Applicazioni Scooter
Aplicaciones Scooter 48-54

Applications Maxi-Scooter

Maxi-Scooter applications
Applicazioni Maxi-Scooter
Aplicaciones Maxi-Scooter 55-60

Applications par référence

Buyers guide / Applicazioni per codice
Aplicaciones por referencia
Motos & QUAD / Motorcycles & ATV
Motocicli & Quad / Motos & ATV 61-154

Applications par référence

Buyers guide / Applicazioni per codice
Aplicaciones por referencia
Scooter / Maxi Scooter 155-190

Tableau d'équivalences

Interchange list / Austauschliste
Tabella comparativa / Tablero de equivalencia 192-194

Notes / Notes / Note / Notas 195

Garanties et certifications

Warranty and quality insurance
Garanzia / Garantías 196-197

CL Brakes Wettbewerb
Competizioni
Racing
compétition

Compétition Racing Competizioni
Actividades Racing Wettbewerb



Johann ZARCO - Moto GP World Championship (125cc)

Junior Team Suzuki
Endurance World Championship



Mathieu GINES - Team Tecmas
French Champion 600 Supersport



Team Motor Events
Endurance World Championship





Ludivine PUY
Enduro World Champion



Rodrig THAIN
ISDE World Championship
(Enduro)



Team Bud Racing
Motocross World Championship (MX1)



Team SF3 Peugeot
French Champion (Scooter)

Recherche & Développement

Ricerca & Sviluppo

Research & Development

Forschung & Entwicklung

Investigación y Desarrollo

La division Frein Moto de CLBrakes possède son propre département R&D avec son banc d'essai dédié à la recherche moto.

Il simule le plus fidèlement possible les conditions d'utilisation d'un 2 roues lors des phases de freinage.

Les programmes de freinage développés en relation étroite avec nos teams et pilotes de pointe nous permettent d'élaborer des programmes de simulation aptes à reproduire à l'aide de systèmes embarqués d'acquisition de données les conditions de freinage les plus diverses.

Les nouvelles compositions sont alors élaborées par nos ingénieurs en matériaux puis testées sur le banc d'essai.

La validation de ces nuances se termine par une phase de tests en condition réelle.

Nous n'avons de cesse de mettre en œuvre tous nos moyens pour nous permettre de faire évoluer notre gamme de plaquettes et de proposer le produit le plus adapté aux attentes des motards.

CLBrakes Braking Motorcycle Division has its own R&D Department dedicated to motorcycle research.

It simulates 2-wheel braking conditions nearest reality.

Braking programs developed by our teams and top riders allow us to create simulation software that will reproduce with embarked systems of data acquisition to the greatest variety of braking conditions.

New brake pad compounds are created by our material engineers and tested on our in house dynamometer.

Compounds are tested in real conditions, as well as before the validation.

We continuously implement improvements into our brake pads to make the product most adaptable to the needs of the modern motorcyclist.

Die Motorradabteilung von CL BRAKES hat ihre eigene Forschung & Entwicklung Abteilung, welche das Bremsen unter Realitaetsbedingungen simuliert.

Die Bremsprogramme welche mit Hilfe von unseren Spitzenfahrern und Top

Teams unter dem Einsatz von Data Acquisition entwickelt worden, erlauben uns mit unserer Simulations Software die verschiedenen Bremsbedingungen und Abläufe zu simulieren.

Unsere Material Ingenieure entwickeln staendig neue Bremsbelag Mischungen und testen diese auf unserem eigenen Bremsenteststand.

Diese neuen Belagmischungen werden dann auf der Teststrecke unter Realitaetsbedingungen von unseren Testfahrern getestet.

Staedig werden Verbesserungen in unsere Brembelag Produktpalette eingefuehrt um alle Anforderungen des modernen Motorradfahrers zu erfullen.

La Divisione Freni Moto CLBrakes possiede un proprio dipartimento Ricerca & Sviluppo con il proprio banco prova dedicato in modo specifico alla moto.

Esso simula il più fedelmente possibile le condizioni di utilizzo di una moto durante le varie fasi di frenaggio.

I programmi di frenaggio sviluppati in stretta collaborazione con i nostri team e piloti di punta, ci permettono di elaborare dei programmi di simulazione atti a riprodurre, grazie all'aiuto di sofisticati sistemi di acquisizione dati, le più diverse condizioni di frenaggio.

I nuovi composti vengono allora elaborati materialmente dai nostri ingegneri e in seguito testati sul banco prova.

La validazione di queste mescole termina con una fase di test in condizioni reali.

Lavoriamo costantemente con tutti i mezzi a nostra disposizione perché la nostra gamma di pastiglie freno sia sempre aggiornata e perché risponda il più possibile alle esigenze dei piloti.

La división Frenos Moto de CLBrakes posee su propio departamento de I&D, con banco de pruebas dedicado a la investigación en el campo de la motocicleta.

En él se simulan lo más fielmente posible las condiciones de utilización de una moto en sus diferentes fases de frenado.

Los programas de frenado desarrollados en estrecha colaboración con nuestros equipos y pilotos de punta, nos permiten



elaborar con la ayuda de los sistemas embarcados programas de simulación de las condiciones de frenado más diversas. Los nuevos compuestos son entonces elaborados por nuestros ingenieros de materiales y luego ensayados en el banco de pruebas.

La validación de estas calidades termina con otra fase de ensayos en condiciones reales.

Una continua puesta al día de nuestros medios, nos permite evolucionar nuestra gama de plaquitas y poder proponer el producto mejor adaptado a las necesidades del motorista.



Gamme plaquettes de frein

"Une plaquette adaptée pour chaque usage"

Gamma prodotti

"Scegliete la pastiglia piu' adatta alle vostre esigenze"

Palette Bremsbelag

Brake pads range

"A specific brake pad for each application"

Gama productos

"Escoja la pastilla mas adaptable a vuestra necesidad"

| SCOOTER | | ROUTE & VILLE Street and city | | SPORT | ROUTE RACING Street Racing | TOUT-TERRAIN Off-road | | QUADS ATV | |
|-------------------------|---------------------|--------------------------------------|--------------------------------------------------------|---------------------------|----------------------------------------------------------|--------------------------|-------------|--------------|-------------|
| Scooters <125 cc | Scooters >125 cc | Petites cylindrées Light bikes | Moyennes et grosses cylindrées Powerful bikes | Supersport Super-sport | Courses uniquement sur circuits Racing use only | ENDURO | CROSS | Quads ATV | |
| FRONT AVANT | SC | MAXI-SC | S4 | A3+ | XBK5 | C59 | EN10 | MX10 | ATV1 |
| REAR ARRIÈRE | SC | MAXI-SC | S4 RX3 | RX3 | RX3 | RX3 | X59 | X59 | ATV1 |

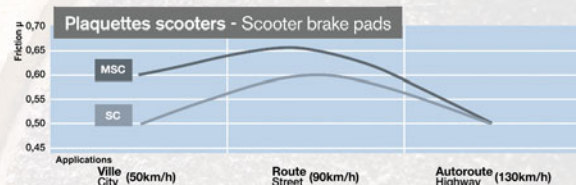
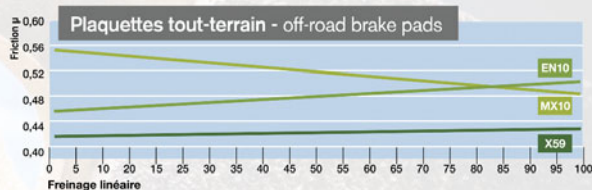
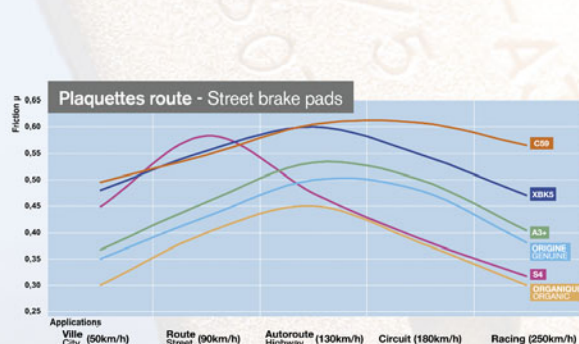

NoNiTech®

La plupart des plaquettes en métal fritté sont produites à base de nickel. Certaines études ont montré que celui-ci pouvait être dangereux pour la santé : risque allergène et cancérigène. Pourtant rien ne l'interdit... Sensible à ce problème, la recherche CLBrakes a développé NONiTECH : The NO NICKEL TECHNOLOGY. Afin de protéger ses employés, ses clients et l'environnement, CLBrakes a conçu ses produits sans plomb, sans amiante ni nickel et a fait ainsi le choix du développement durable.

Most sintered brake pads are made with nickel. Some studies have shown that nickel can jeopardize your health (allergic and carcinogenic risks). However, there are no restrictions prohibiting its use. Aware of this problem, CLBrakes research has developed NONiTECH: The NO NICKEL TECHNOLOGY. To protect its employees, its clients and the environment, CLBrakes products are free of lead, asbestos and nickel; and CLBrakes opts for sustainable development.

Die am meisten hergestellten Bremsbelege werden mit einem Anteil Nickel hergestellt. Die meisten Studien haben erwiesen, daß Nickel zu einer Gesundheitsgefährdung führen kann (Es besteht ein Allergie- und Krebsrisiko). Jedoch ist kein Verbot für den Einsatz dieses Materials geplant. Auf dieses Problem aufmerksam geworden, wurde durch die Entwicklungsabteilung von CLBrakes NONiTECH entwickelt. NONiTECH wird nickelfrei hergestellt. Damit bietet NONiTECH einen exzellenten Schutz für die Kunden, die Umwelt und Mitarbeiter. CLBrakes Produkte sind frei von Blei, Asbest und Nickel, und Carbone handelt zugunsten einer nachhaltigen Entwicklung.

La maggior parte delle pastiglie freno in metallo sinterizzato sono prodotte a base di Nichel. Alcuni studi hanno dimostrato che questa sostanza può essere dannosa alla salute, provocando allergie e tumori. Nonostante questo non c'è nessuna legge che ne impedisca l'utilizzo... Cosciente di questo problema, il dipartimento di Ricerca & Sviluppo CLBrakes ha creato NONiTECH: LA TECNOLOGIA NO NICHEL. Al fine di proteggere i suoi dipendenti, la clientela e l'ambiente, CLBrakes ha concepito prodotti senza piombo, amianto e nichel, scegliendo così la strada dello sviluppo sostenibile.

La mayoría de las pastillas de freno sinterizadas son fabricadas a base de níquel. Algunos estudios han demostrado que este metal puede ser peligroso para la salud: riesgo alérgico y cancerígeno. Sin embargo ninguna legislación lo prohíbe... Consciente de este problema, el departamento de I&D de CLBrakes ha creado NONiTECH: NO NICKEL TECHNOLOGY. Para proteger a sus empleados, a sus clientes y al medio ambiente, CLBrakes ha creado sus productos sin plomo, sin amianto y sin níquel, y así ha escogido el camino del desarrollo sostenible.





Assurance Qualité Garanzia di Qualità Quality Insurance Calidad Asegurada Qualitätskontrolle

Faiveley Transport Gennevilliers a mis en place un Système de Gestion et d'Assurance qualité afin de répondre aux exigences de fiabilité lors de l'utilisation des plaquettes de frein moto, quad, scooter, karting, VTT...

Le Système Qualité de Faiveley Transport Gennevilliers se réfère aux différentes normes en vigueur en France et à l'étranger (ISO 9001, TÜV...).

L'objectif est de garantir, au travers des différents stades de production :

- un contrôle des matières et des fournisseurs
- un contrôle de la fabrication
- un contrôle de l'emballage, du stockage et de la livraison
- une traçabilité
- un niveau de qualité comparable à celui des produits de première monte des grands constructeurs de motos.

Soucieux de la protection de l'environnement, en conformité avec la norme 14001 et pour garantir votre sécurité, les produits Faiveley Transport Gennevilliers ne contiennent ni plomb, ni amiante, ni nickel.

Faiveley Transport Gennevilliers has implemented the Quality Administration and Control System to meet the highest quality requirements needed to ensure the best reliability for its brake pads.

The system refers to both french and international standards (ISO 9001, TÜV...).

The objective is to guarantee all manufacturing operations:

- control of raw materials and suppliers
- manufacturing control
- tracking
- packaging, storage and delivery control
- a quality equivalent to the OEM requirements.

Concerned by the environmental protection, in conformity with the 14001 standard and for your safety, Faiveley Transport Gennevilliers products are free of lead, nickel and asbestos.

Faiveley Transport Gennevilliers verfügt über eine eigene Qualitätskontrolle, um die höchsten Anforderungen für die beste Beständigkeit ihrer Bremssysteme und Bremsbeläge zu gewährleisten. Das System erfüllt die deutschen, französischen und Internationalen Standards (ISO 9001, TÜV...).

Die Standards sind für alle Produktionsschritte garantiert:

- Die Kontrolle des Rohmaterials und der Lieferanten
- Kontrolle des Herstellungsprozesses
- Verpackung-, Lagerungs- und Versandkontrolle
- Das Produkt bietet ein vergleichbares Equivalent zu den OEM Herstellern,
- Schutz der Umwelt.



Faiveley Transport Gennevilliers ha implementato la Gestione del Controllo di Qualità ed il Sistema di Controllo Qualità per ottemperare ai più severi standard qualitativi necessari per assicurare la più alta affidabilità delle proprie pastiglie freno.

Il sistema fa riferimento agli standard sia francesi che internazionali (ISO 9001, TUV...).

L'obiettivo è di garantire in ciascuna fase di produzione :

- controllo delle materie prime e dei fornitori
- controllo del processo produttivo, imballo, stoccaggio e controllo delle consegne
- una qualità equivalente all'Originale
- tracciabilità.

Sensible alla protezione ambientale, in conformità con la norma 14001 e soprattutto per la vostra sicurezza, Faiveley Transport Gennevilliers non utilizza per i suoi prodotti sostanze nocive come piombo, amianto o nichel.

Faiveley Transport Gennevilliers ha llevado a cabo la Administración de Calidad y Sistema de Control para reunir los requisitos necesarios para asegurar la fiabilidad de sus pastillas de freno.

El sistema utilizado hace referencia a las normas francesas e internacionales (ISO 9001, TUV...)

El objetivo es de garantizar, a través de las diferentes fases de producción :

- control de las materias primas y de los proveedores
- control de fabricación
- control del embalaje, almacenamiento y entregas
- una calidad equivalente a los requisitos de la OEM.

Preocupado por el medio ambiente, en conformidad con la norma 14001 y para su seguridad, los productos Faiveley Transport Gennevilliers no contienen plomo, amianto ni níquel.



Matériel promotionnel

Promotional material Vêtements - Clothes

Présentoir - Display



Fronton
Header
Réf. GVC 300 CL

Présentoir en 2 parties
50 ou 100 jeux
Display in 2 parts
50 or 100 sets
Réf. GVC 201 CL1

Autocollants - Stickers



135 x 47 mm
Réf. GVC 900 CL301



135 x 47 mm
Réf. GVC 900 CL303



Tout terrain - Off road
Réf. GVC 900 CL304



735 x 234 mm
Réf. GVC 900 CL302



735 x 234 mm
Réf. GVC 900 CL311

Banderole - Banner



3000 x 600 mm
Réf. GVC 900 CL600

Porte-clé - Key Ring



Réf. GVC 900 CL200

Liquide de frein - Brake fluid



Liquide de frein haute performance
Brake fluid high performance
Réf. GVC 900 CL100

Tee-shirt

- S - GVC 900 CL465
- M - GVC 900 CL462
- L - GVC 900 CL460
- XL - GVC 900 CL461
- XXL - GVC 900 CL463



Polo - Shirt

- M - GVC 900 CL442
- L - GVC 900 CL440
- XL - GVC 900 CL441
- XXL - GVC 900 CL443



Body warmer

- M - GVC 900 CL332
- L - GVC 900 CL330
- XL - GVC 900 CL331
- XXL - GVC 900 CL333



Polaire - Polar fleece

- M - GVC 900 CL432
- L - GVC 900 CL430
- XL - GVC 900 CL431
- XXL - GVC 900 CL433



Parka

- M - GVC 900 CL472
- L - GVC 900 CL470
- XL - GVC 900 CL471





109-XBK5
17/5

Route *Street*

ALFER

| | | | | | | | | | |
|----|-----|-------------|------|---|-------------|------|-----|-------------|-----|
| VR | 250 | Supermotard | 99 - | 1 | 2352 | XBK5 | A3+ | 2353 | RX3 |
|----|-----|-------------|------|---|-------------|------|-----|-------------|-----|

AJP

| | | | | | | | | | |
|-----|-----|-------------|------|---|-------------|------|-----|-----------|--|
| PR3 | 125 | Supermotard | 08 - | 1 | 1146 | XBK5 | | NA | |
| PR4 | 125 | Supermotard | 04 - | 1 | NA | | | NA | |
| PR3 | 200 | Supermotard | 08 - | 1 | 1146 | XBK5 | | NA | |
| PR4 | 200 | Supermotard | 04 - | 1 | NA | | | NA | |
| PR5 | 250 | Supermotard | 09 - | 1 | 2300 | XBK5 | A3+ | NA | |

APRILIA

| | | | | | | | | | |
|------|-----|---------------------|---------|---|-------------|------|-----|-------------|-----|
| E.T. | 50 | | 85 - | 1 | 2249 | A3+ | S4 | 2249 | RX3 |
| | 125 | Classic | 96 - | 1 | 1144 | S4 | | 2249 | RX3 |
| | 125 | Pegaso | 90 - 91 | 1 | 1144 | S4 | | 2306 | RX3 |
| | 125 | Pegaso | 92 - | 1 | 1146 | S4 | | 2472 | RX3 |
| | 125 | Red Rose | 89 | 1 | 2794 | A3+ | S4 | 2249 | RX3 |
| | 125 | Red Rose | 90 - | 1 | 1144 | S4 | | 2249 | RX3 |
| | 125 | Sport Prot. | 92 | 1 | 2398 | A3+ | | 2249 | RX3 |
| | 125 | Tuareg | - 86 | 1 | 2794 | A3+ | S4 | T | |
| | 125 | Tuareg | 87 - | 1 | NA | | | 2249 | RX3 |
| | 125 | Tuareg Rally | 86 - 88 | 1 | 2794 | A3+ | S4 | T | |
| | 125 | Tuareg Rally | 89 | 1 | 2794 | A3+ | S4 | 2249 | RX3 |
| | 125 | Tuareg Rally | 90 - 91 | 1 | 2400 | A3+ | S4 | 2249 | RX3 |
| | 125 | Tuareg Rally | 92 | 1 | 1144 | S4 | | 2472 | RX3 |
| | 125 | Tuareg Wind | 88 | 1 | 2260 | S4 | | 1089 | RX3 |
| | 125 | Tuareg Wind | 90 - | 1 | 1144 | S4 | | 2306 | RX3 |
| | 125 | Tuono | 04 - | 1 | 2398 | A3+ | | 2249 | RX3 |
| AF 1 | 125 | | 87 - | 1 | 2400 | A3+ | S4 | 2249 | RX3 |
| AF 1 | 125 | Europa / Futura | 90 - 91 | 1 | 2398 | A3+ | | 2249 | RX3 |
| AF 1 | 125 | Replica / Sintesi | 89 - 91 | 1 | 2398 | A3+ | | 2249 | RX3 |
| ETX | 125 | | - 86 | 1 | 2794 | A3+ | S4 | T | |
| ETX | 125 | | 86 - 87 | 1 | 2794 | A3+ | S4 | 2249 | RX3 |
| MX | 125 | Cross | 85 | 1 | 2794 | A3+ | S4 | T | |
| MX | 125 | | 04 - | 1 | 2352 | A3+ | | 2472 | RX3 |
| MX | 125 | SM | 07 - | 1 | 2352 | A3+ | | 2472 | RX3 |
| RS | 125 | / Extrema / Replica | 93 - 98 | 1 | 2398 | XBK5 | A3+ | 1167 | RX3 |
| RS | 125 | | 99 - 05 | 1 | 2398 | XBK5 | A3+ | 1167 | RX3 |
| RS | 125 | | 06 - | 1 | 1187 | XBK5 | | NA | RX3 |
| RS | 125 | R Piste | 04 - 05 | 1 | 2398 | XBK5 | A3+ | 1167 | RX3 |
| RX | 125 | | 92 - 07 | 1 | 1146 | S4 | | 2306 | RX3 |
| RX | 125 | Enduro | 08 | 1 | 2352 | A3+ | | 2469 | S4 |
| RX | 125 | Supermotard | 08 - | 1 | 2352 | A3+ | | 2469 | S4 |
| SX | 125 | | 08 - | 1 | 2352 | A3+ | | 2469 | S4 |
| | 250 | Tuareg Rally | 86 - | 1 | 2794 | A3+ | S4 | 2249 | RX3 |
| AF 1 | 250 | Replica | 90 - | 1 | 2398 | A3+ | | 2332 | RX3 |
| RS | 250 | | 95 - 96 | 1 | 2247 | XBK5 | A3+ | 2249 | RX3 |
| RS | 250 | | 97 - 02 | 2 | 2539 | XBK5 | A3+ | 2249 | RX3 |
| RS | 250 | R Piste | 04 - | 2 | 2539 | XBK5 | A3+ | 2249 | RX3 |
| | 350 | Tuareg | 86 - 87 | 1 | 2794 | A3+ | S4 | 2249 | RX3 |
| | 350 | Tuareg | 88 - 89 | 1 | 2400 | A3+ | | 2249 | RX3 |
| | 350 | Tuareg Wind | 87 | 1 | 2794 | A3+ | S4 | 2249 | RX3 |
| | 350 | Tuareg Wind | 88 | 1 | 2801 | A3+ | | 2249 | RX3 |
| | 350 | Tuareg Wind | 90 - | 1 | 2400 | A3+ | | 2306 | RX3 |
| ETX | 350 | | - 86 | 1 | 2794 | A3+ | S4 | 2249 | RX3 |
| ETX | 350 | | 86 - | 1 | NA | | | 2249 | RX3 |
| SXV | 450 | | 06 - | 1 | NA | | | 1103 | RX3 |
| SXV | 450 | Van den Bosh Rep. | 08 - | 1 | 2329 | XBK5 | | 1103 | RX3 |
| SXV | 550 | | 06 - | 1 | NA | | | 1103 | RX3 |
| SXV | 550 | Van den Bosh Rep. | 08 - | 1 | 2329 | XBK5 | | 1103 | RX3 |
| ETX | 600 | | 86 - | 1 | 2794 | A3+ | | 2249 | RX3 |
| | 600 | Pegaso | 90 - | 1 | 2400 | A3+ | | 2472 | RX3 |
| | 600 | Tuareg | 86 - 87 | 1 | 2794 | A3+ | | 2249 | RX3 |
| | 600 | Tuareg | 88 - | 1 | 2400 | A3+ | | 2306 | RX3 |
| | 600 | Tuareg Wind | 88 | 1 | 2801 | A3+ | | 2249 | RX3 |
| | 600 | Tuareg Wind | 90 - | 1 | 2400 | A3+ | | 2306 | RX3 |
| | 650 | Moto 6.5 | 95 - | 1 | 2396 | A3+ | | 2306 | RX3 |
| | 650 | Pegaso | 92 - 96 | 1 | NA | | | 2472 | RX3 |
| | 650 | Pegaso | 97 - 00 | 1 | 2396 | A3+ | | 2306 | RX3 |
| | 650 | Pegaso i.e | 01 - | 1 | 2396 | A3+ | | 2353 | RX3 |
| | 650 | Pegaso i.e TTR | 04 - | 1 | 2396 | A3+ | | 2353 | RX3 |
| | 650 | Pegaso Strada | 05 - | 1 | 2539 | XBK5 | A3+ | 2353 | RX3 |
| | 650 | Pegaso Trail | 06 - | 1 | 2396 | A3+ | | 2353 | RX3 |
| | 650 | Pegaso Factory | 07 - | 1 | NA | | | 2353 | RX3 |
| | 750 | Shiver | 07 - | 2 | 1187 | XBK5 | | 2353 | RX3 |
| | 750 | Shiver GT | 09 - | 2 | 1187 | XBK5 | | 2353 | RX3 |
| SMV | 750 | Dorsoduro | 08 - | 2 | 1187 | XBK5 | | 2353 | RX3 |
| SMV | 750 | Dorsoduro Factory | 10 - | 2 | 2539 | XBK5 | A3+ | 2353 | RX3 |
| NA | 850 | Mana | 07 | 2 | 1187 | XBK5 | | 2353 | RX3 |
| NA | 850 | Mana | 08 - | 2 | 1187 | XBK5 | | NA | RX3 |
| NA | 850 | Mana GT | 09 - | 2 | 1187 | XBK5 | | NA | RX3 |

1 - 2 - 4 = Nombre de jeux / Number of sets / Anzahl Sets Numero blister / Numero des juegos
 L = Gauche / Left / Links / Sinistra / Izquierda
 R = Droite / Right / Rechts / Destra / Derecha
 NA = Non Attribué / Not Available / Nicht verfügbar / Non disponible / No disponible

APRILIA

| | | | | | | | | | |
|------|------|---------------------|---------|---|-------------|------|-----|-------------|-----|
| ETV | 1000 | Caponord | 01 - | 2 | 2396 | A3+ | | 2827 | RX3 |
| ETV | 1000 | Caponord Rally Raid | 04 - | 2 | 2396 | A3+ | | 2827 | RX3 |
| RST | 1000 | Futura | 01 - | 2 | 2539 | XBK5 | A3+ | 2352 | RX3 |
| RSV | 1000 | | 97 - 01 | 2 | 2539 | XBK5 | A3+ | 2827 | RX3 |
| RSV | 1000 | | 02 - | 2 | 1033 | XBK5 | A3+ | 2827 | RX3 |
| RSV | 1000 | Factory Pista | 04 - | 2 | 1033 | XBK5 | A3+ | 2827 | RX3 |
| RSV | 1000 | Nera | 04 - | 2 | 1033 | XBK5 | A3+ | 2827 | RX3 |
| RSV | 1000 | R | 00 | 2 | 2539 | XBK5 | A3+ | 2827 | RX3 |
| RSV | 1000 | R | 01 - 02 | 2 | 1033 | XBK5 | A3+ | 2827 | RX3 |
| RSV | 1000 | R | 03 - | 2 | 1033 | XBK5 | A3+ | 2827 | RX3 |
| RSV | 1000 | R Factory Replica | 04 - | 2 | 1033 | XBK5 | A3+ | 2827 | RX3 |
| RSV | 1000 | SP | 00 - | 2 | 2539 | XBK5 | A3+ | 2827 | RX3 |
| RSV | 1000 | Tuono Fighter | 03 - 05 | 2 | 1033 | XBK5 | A3+ | 2827 | RX3 |
| RSV | 1000 | Tuono R | 03 | 2 | 2539 | XBK5 | A3+ | 2827 | RX3 |
| RSV | 1000 | Tuono R Factory | 04 - | 2 | 2539 | XBK5 | A3+ | 2827 | RX3 |
| RSV4 | 1000 | Factory | 09 - | 2 | 1185 | XBK5 | A3+ | 2827 | RX3 |
| RSV4 | 1000 | R | 10 - | 2 | 1185 | XBK5 | A3+ | 2827 | RX3 |
| SL | 1000 | Falco | 00 - | 2 | 2539 | XBK5 | A3+ | 2827 | RX3 |

ASPES

| | | | | | | | | | |
|--|-----|---------|------|---|-------------|-----|--|-------------|-----|
| | 125 | Sintesi | 88 - | 1 | 2398 | A3+ | | 2249 | RX3 |
|--|-----|---------|------|---|-------------|-----|--|-------------|-----|

BATAVUS

| | | | | | | | | | |
|--|--|------------|------|---|-------------|-----|----|----------|--|
| | | Grand prix | 80 - | 1 | 2306 | A3+ | S4 | T | |
|--|--|------------|------|---|-------------|-----|----|----------|--|

BENELLI

| | | | | | | | | | |
|-------|-----|--------------|---------|---|-------------|------|-----|-------------|-----|
| | 50 | Devil | 92 | 1 | 2398 | A3+ | S4 | T | |
| | 50 | Spring | 92 | 1 | 2398 | A3+ | S4 | T | |
| | 124 | T | 83 - | 1 | 2249 | A3+ | S4 | T | |
| | 125 | 2CE | 76 - 78 | 1 | 2249 | A3+ | S4 | T | |
| | 125 | Custom | 85 | 1 | 2249 | A3+ | S4 | T | |
| | 125 | Jarno | 89 | 2 | 2398 | A3+ | S4 | 2249 | RX3 |
| | 125 | Sport | | 1 | 2249 | A3+ | S4 | T | |
| | 125 | T | 76 - | 1 | 2249 | A3+ | S4 | T | |
| | 125 | TT | | 1 | 2249 | A3+ | S4 | T | |
| BX | 125 | | 89 | 1 | 2398 | A3+ | S4 | 2249 | RX3 |
| BXK | 125 | | 88 | 1 | 2249 | A3+ | S4 | 2377 | RX3 |
| E | 125 | LC | 85 | 1 | 2249 | A3+ | S4 | T | |
| 666 | 125 | Born in hell | 98 - | 1 | 2539 | A3+ | S4 | 1167 | RX3 |
| | 250 | 2CE | | 1 | 2249 | A3+ | S4 | T | |
| | 250 | Disc | 76 - | 1 | 2249 | A3+ | S4 | T | |
| | 304 | | 83 - | 1 | 2249 | A3+ | | T | |
| | 350 | 4T Turismo | | 1 | 2249 | A3+ | | 2332 | RX3 |
| | 354 | | 78 - 82 | 2 | 2249 | A3+ | | 2332 | RX3 |
| | 354 | Sport | 83 - | 2 | 2249 | A3+ | | 2249 | RX3 |
| BX | 449 | Supermotard | 08 - | 1 | 1033 | XBK5 | A3+ | 2353 | RX3 |
| | 500 | 4T | - 76 | 1 | 2249 | A3+ | | 2332 | RX3 |
| | 500 | -4 | 76 - | 2 | 2249 | A3+ | | T | |
| | 654 | Sport | 83 | 2 | 2249 | XBK5 | A3+ | 2249 | RX3 |
| | 750 | Sei | 75 - | 2 | 2332 | A3+ | | 2332 | RX3 |
| 2ue | 756 | Cue | 07 - 09 | 2 | 1033 | XBK5 | A3+ | 2827 | RX3 |
| 2ue | 756 | Cue | 10 - | 2 | 2539 | XBK5 | A3+ | 2827 | RX3 |
| Tre-K | 899 | / Sport | 07 - | 2 | 2539 | XBK5 | A3+ | 2827 | |



BIMOTA

| | | | | BEST CHOICE | | OTHER CHOICE | | BEST CHOICE | |
|-------|-------------------|---------|---|-------------|----------|--------------|-----|-------------|--|
| YB7 | 400 | 89 | 2 | 2247 | XBK5 A3+ | 2249 | RX3 | | |
| V Due | 500 TESI 2 | 97 - | 2 | 2247 | XBK5 A3+ | 2249 | RX3 | | |
| | 600 Bellaria | 91 - | 2 | 2247 | XBK5 A3+ | 2249 | RX3 | | |
| YB9 | 600 SRI | 96 - | 2 | 2247 | XBK5 A3+ | 2249 | RX3 | | |
| BB1 | 650 Supermono | 96 - | 2 | 2247 | XBK5 A3+ | 2249 | RX3 | | |
| SB7 | 750 | 96 - | 2 | 2247 | XBK5 A3+ | 2249 | RX3 | | |
| YB4 | 750 | 89 | 2 | 2247 | XBK5 A3+ | 2249 | RX3 | | |
| 1D | 851 Tesi | 91 - 95 | 2 | 2247 | XBK5 A3+ | 2249 | RX3 | | |
| | 900 Mantra | 96 - | 2 | 2247 | XBK5 A3+ | 2249 | RX3 | | |
| DB2 | 900 | 92 - | 2 | 2247 | XBK5 A3+ | 2249 | RX3 | | |
| DB4 | 900 | 99 - | 2 | 2539 | XBK5 A3+ | 2249 | RX3 | | |
| 1D | 904 Tesi SR / ES | 96 - | 2 | 2247 | XBK5 A3+ | 2249 | RX3 | | |
| DB2 | 904 HF / SR | 96 - | 2 | 2247 | XBK5 A3+ | 2249 | RX3 | | |
| 1D | 906 Tesi | 91 - 95 | 2 | 2247 | XBK5 A3+ | 2249 | RX3 | | |
| 2D | 1000 Tesi | 04 - 06 | 2 | 2247 | XBK5 A3+ | 2249 | RX3 | | |
| DB5 | 1000 Mille | 05 - | 2 | 1033 | XBK5 A3+ | 2827 | RX3 | | |
| DB5 | 1000 R | 07 - | 2 | 1033 | XBK5 A3+ | 2827 | RX3 | | |
| DB5 | 1000 S | 07 - | 2 | 1033 | XBK5 A3+ | 2827 | RX3 | | |
| DB6 | 1000 Delirio | 07 - | 2 | 1033 | XBK5 A3+ | 2827 | RX3 | | |
| SB8 | 1000 R | 98 - | 2 | 2539 | XBK5 A3+ | 2249 | RX3 | | |
| SB8K | 1000 | 06 - | 2 | 2539 | XBK5 A3+ | 2249 | RX3 | | |
| SB8K | 1000 Santamonica | 07 - | 2 | 1033 | XBK5 A3+ | 2249 | RX3 | | |
| YB11 | 1000 | 97 - | 2 | 2247 | XBK5 A3+ | 2249 | RX3 | | |
| YB6 | 1000 | 89 | 2 | 2247 | XBK5 A3+ | 2249 | RX3 | | |
| YB8 | 1000 | 90 - 95 | 2 | 2247 | XBK5 A3+ | 2249 | RX3 | | |
| YB11 | 1002 Dieci | 91 - 95 | 2 | 2247 | XBK5 A3+ | 2249 | RX3 | | |
| YB11 | 1002 Superleggera | 96 | 2 | 2247 | XBK5 A3+ | 2249 | RX3 | | |
| DB7 | 1098 (Rad. Cal) | 08 - | 2 | 1033 | XBK5 A3+ | 2827 | RX3 | | |
| DB7 | 1099 (Rad. Cal) | 09 - | 2 | 1185 | XBK5 A3+ | 2249 | RX3 | | |
| 3D | 1100 Tesi | 07 - | 2 | 1033 | XBK5 A3+ | 2827 | RX3 | | |
| DB6R | 1100 Delirio | 08 - | 2 | 1033 | XBK5 A3+ | 2827 | RX3 | | |
| SB6 | 1100 | 96 - | 2 | 2247 | XBK5 A3+ | 2249 | RX3 | | |
| SB6 | 1100 R | 97 - | 2 | 2247 | XBK5 A3+ | 2249 | RX3 | | |
| 1D | Tesi | 93 - | 2 | 2247 | XBK5 A3+ | 2249 | RX3 | | |
| DB2 | | 92 - | 2 | 2247 | XBK5 A3+ | 2249 | RX3 | | |
| | All models | 89 - 98 | 2 | 2247 | XBK5 A3+ | 2249 | RX3 | | |
| | Furano | 92 - | 2 | 2247 | XBK5 A3+ | 2249 | RX3 | | |
| | All models | 82 - 88 | 2 | 2332 | A3+ | 2332 | RX3 | | |

BLATA

| | | | | | | | | | |
|-----|--------|------|---|----|--|------|-----|--|--|
| 125 | Motard | 07 - | 1 | NA | | 2377 | RX3 | | |
|-----|--------|------|---|----|--|------|-----|--|--|

BMW

| | | | | | | | | | |
|-------|----------------|------------|---|------|----------|----|------|-----|--|
| 125 | C1 | 00 - | 1 | 2396 | A3+ | S4 | 2353 | RX3 | |
| 200 | C1 | 02 - | 1 | 2396 | A3+ | S4 | 2353 | RX3 | |
| G | 450 SMR | 09 - | 1 | 1033 | XBK5 A3+ | | 1108 | RX3 | |
| G | 650 Xchallenge | 07 - | 1 | 2396 | A3+ | | 2353 | RX3 | |
| G | 650 Xcountry | 07 - | 1 | 2396 | A3+ | | 2353 | RX3 | |
| G | 650 Xmoto | 07 - | 1 | 2539 | XBK5 A3+ | | 2353 | RX3 | |
| F | 650 CS Scarver | 02 - 06 | 1 | 2396 | A3+ | | 2353 | RX3 | |
| F | 650 Funduro | 94 - 00 | 1 | 2396 | A3+ | | 2353 | RX3 | |
| F | 650 GS | 08 - | 1 | 2396 | A3+ | | 2353 | RX3 | |
| F | 650 GS Rallye | 01 - 07 | 1 | 2396 | A3+ | | 2353 | RX3 | |
| F | 650 GS Dakar | 01 - 07 | 1 | 2396 | A3+ | | 2353 | RX3 | |
| F | 650 Strada | 97 - | 1 | 2396 | A3+ | | 2353 | RX3 | |
| R65 | 650 | 86 - | 1 | 2332 | A3+ | | T | | |
| R65 | 650 GS | 87 - 92 | 1 | 2332 | A3+ | | T | | |
| R65 | 650 LS | 82 - | 2 | 2332 | A3+ | | T | | |
| R65/1 | 650 | 86 - | 1 | 2840 | A3+ | | 2332 | RX3 | |
| K75 | 750 | 09/88 - | 1 | 2258 | A3+ | | 2332 | RX3 | |
| K75 | 750 C | 85 - 08/89 | 2 | 2332 | A3+ | | 2332 | RX3 | |
| K75 | 750 RT (ABS) | 91 - | 2 | 2258 | A3+ | | 2332 | RX3 | |
| K75 | 750 S | 85 - 08/88 | 2 | 2332 | A3+ | | 2332 | RX3 | |
| K75 | 750 S | 09/88 - | 1 | 2258 | A3+ | | 2332 | RX3 | |
| F | 800 GS | 08 | 2 | 2396 | A3+ | | 2353 | RX3 | |
| F | 800 R | 09 - | 2 | 2539 | XBK5 A3+ | | 2353 | RX3 | |
| F | 800 S | 06 - | 2 | 2539 | XBK5 A3+ | | 2353 | RX3 | |
| F | 800 ST | 06 - | 2 | 2539 | XBK5 A3+ | | 2900 | RX3 | |
| R80 | 800 GS | 81 - 84 | 1 | 2332 | A3+ | | T | | |
| R80 | 800 GS | 85 - 08/88 | 1 | 2258 | A3+ | | T | | |
| R80 | 800 GS | 88 - 93 | 1 | 2840 | A3+ | | T | | |
| R80 | 800 R Roadster | 91 - | 1 | 2430 | A3+ | | T | | |
| R80 | 800 RT | 83 | 2 | 2332 | A3+ | | T | | |
| R80 | 800 RT | 08/89 - | 1 | 2258 | A3+ | | T | | |
| R80 | 800 | 85 - 08/88 | 1 | 2258 | A3+ | | T | | |
| R | 850 C | 98 - | 2 | 2430 | XBK5 A3+ | | 2900 | RX3 | |
| R | 850 GS | 98 - | 2 | 2430 | XBK5 A3+ | | 2900 | RX3 | |
| R | 850 R | 95 - 02 | 2 | 2430 | XBK5 A3+ | | 2900 | RX3 | |
| R | 850 R | 03 - | 2 | 2960 | A3+ | | 2900 | RX3 | |

BMW

| | | | | | | | | | |
|------|-----------------------------|------------|---|------|----------|------|-----|--|--|
| R | 850 RT | 98 - 00 | 2 | 2430 | XBK5 A3+ | 2900 | RX3 | | |
| R | 850 RT ABS | 01 - | 2 | 1101 | XBK5 A3+ | 2900 | RX3 | | |
| K1 | 1000 | 89 - 93 | 2 | 2430 | XBK5 A3+ | 2332 | RX3 | | |
| K100 | 1000 GS | 87 - 93 | 1 | 2840 | A3+ | 2332 | RX3 | | |
| K100 | 1000 LT | 92 - | 2 | 2430 | A3+ | 2332 | RX3 | | |
| K100 | 1000 LT / RS | 09/88 - 90 | 2 | 2258 | A3+ | 2332 | RX3 | | |
| K100 | 1000 LT / RS / RT | 83 - 08/88 | 2 | 2332 | A3+ | 2332 | RX3 | | |
| K100 | 1000 LT ABS | 89 | 2 | 2258 | A3+ | 2332 | RX3 | | |
| R100 | 1000 R | 91 - 95 | 1 | 2430 | A3+ | T | | | |
| R100 | 1000 Roadster / Mystic | 93 - 95 | 1 | 2430 | A3+ | T | | | |
| R100 | 1000 RS | 08/89 - | 1 | 2258 | A3+ | T | | | |
| R100 | 1000 RS (4V) | 90 - 92 | 2 | 2430 | A3+ | 2332 | RX3 | | |
| R100 | 1000 RT | 08/89 - 91 | 1 | 2258 | A3+ | T | | | |
| R100 | 1000 RT | 91 - | 2 | 2840 | A3+ | 2332 | RX3 | | |
| S | 1000 RR | 09 - | 2 | 1207 | XBK5 | 2353 | RX3 | | |
| K | 1100 All models | 92 - | 2 | 2430 | XBK5 A3+ | 2332 | RX3 | | |
| K | 1100 LT / LTS | 92 - | 2 | 2430 | XBK5 A3+ | 2332 | RX3 | | |
| K | 1100 RS / RT | 93 - | 2 | 2430 | XBK5 A3+ | 2332 | RX3 | | |
| K | 1100 RS ABS | 93 - | 2 | 2430 | XBK5 A3+ | 2332 | RX3 | | |
| R | 1100 GS | 95 - 99 | 2 | 2430 | XBK5 A3+ | 2900 | RX3 | | |
| R | 1100 GS | 00 - 01 | 2 | 2430 | XBK5 A3+ | 2900 | RX3 | | |
| R | 1100 GS ABS | 95 - 01 | 2 | 2430 | XBK5 A3+ | 2900 | RX3 | | |
| R | 1100 R | 95 - | 2 | 2430 | XBK5 A3+ | 2900 | RX3 | | |
| R | 1100 RS | 93 | 2 | 2430 | XBK5 A3+ | 2332 | RX3 | | |
| R | 1100 RS | 94 - | 2 | 2430 | XBK5 A3+ | 2900 | RX3 | | |
| R | 1100 RS ABS | 93 - | 2 | 2430 | XBK5 A3+ | 2332 | RX3 | | |
| R | 1100 RT | 95 - | 2 | 2430 | XBK5 A3+ | 2900 | RX3 | | |
| R | 1100 RT ABS | 95 - | 2 | 2430 | XBK5 A3+ | 2900 | RX3 | | |
| R | 1100 S | 99 - 00 | 2 | 2430 | XBK5 A3+ | 2900 | RX3 | | |
| R | 1100 S (Brembo Caliper) | 01 - | 2 | 1101 | XBK5 A3+ | 2900 | RX3 | | |
| R | 1100 S ABS (Tokico Caliper) | 01 - | 2 | 2960 | A3+ | 2900 | RX3 | | |
| R | 1150 GS | 00 - 01 | 2 | 2430 | XBK5 A3+ | 2900 | RX3 | | |
| R | 1150 GS / GS Adventure | 02 - | 2 | 1101 | XBK5 A3+ | 2900 | RX3 | | |
| R | 1150 R | 01 - | 2 | 2960 | A3+ | 2900 | RX3 | | |
| R | 1150 R Rockster | 03 - | 2 | 2960 | A3+ | 2900 | RX3 | | |
| R | 1150 RS | 01 - | 2 | 2960 | A3+ | 2900 | RX3 | | |
| R | 1150 RT ABS | 01 - | 2 | 1101 | XBK5 A3+ | 2900 | RX3 | | |
| HP2 | 1200 Enduro | 06 - | 2 | 2396 | XBK5 A3+ | 2900 | RX3 | | |
| HP2 | 1200 Megamoto | 07 - | 2 | 1101 | XBK5 A3+ | 2900 | RX3 | | |
| HP2 | 1200 Sport | 08 - | 2 | 1185 | XBK5 A3+ | 2352 | RX3 | | |
| K | 1200 R Sport | 07 - | 2 | 2960 | A3+ | 2900 | RX3 | | |
| K | 1200 GT ABS | 02 - 04 | 2 | 1101 | XBK5 A3+ | 2332 | RX3 | | |
| K | 1200 GT ABS | 05 - | 2 | 1101 | XBK5 A3+ | 2900 | RX3 | | |
| K | 1200 LT | 99 - 00 | 2 | 2430 | XBK5 A3+ | 2987 | RX3 | | |
| K | 1200 LT ABS | 01 - 05 | 2 | 2960 | A3+ | 2987 | RX3 | | |
| K | 1200 LT ABS | 06 - | 2 | 1101 | XBK5 A3+ | 2900 | RX3 | | |
| K | 1200 R | 05 - | 2 | 2960 | A3+ | 2900 | RX3 | | |
| K | 1200 RS | 99 - 01 | 2 | 2430 | XBK5 A3+ | 2332 | RX3 | | |
| K | 1200 RS | 02 - | 2 | 1101 | XBK5 A3+ | 2900 | RX3 | | |
| K | 1200 S | 05 - | 2 | 1101 | XBK5 A3+ | 2900 | RX3 | | |
| R | 1200 C | 98 - | 2 | 2430 | XBK5 A3+ | 2900 | RX3 | | |
| R | 1200 CL | 03 - | 2 | 2960 | A3+ | 2987 | RX3 | | |
| R | 1200 GS | 04 - | 2 | 1101 | XBK5 A3+ | 2900 | RX3 | | |
| R | 1200 R | 06 - | 2 | 1101 | XBK5 A3+ | 2900 | RX3 | | |
| R | 1200 R | 07 - | 2 | 2960 | A3+ | 2900 | RX3 | | |
| R | 1200 RT | 05 - | 2 | 1101 | XBK5 A3+ | 2900 | RX3 | | |
| R | 1200 S | 05 - | 2 | 1101 | XBK5 A3+ | 2900 | RX3 | | |
| R | 1200 ST | 05 - | 2 | 1101 | XBK5 A3+ | 2900 | RX3 | | |
| K | 1300 GT | 09 - | 2 | 1101 | XBK5 A3+ | 2900 | RX3 | | |
| K | 1300 R | 09 - | 2 | 2960 | A3+ | 2900 | RX3 | | |
| K | 1300 S | 09 - | 2 | 1101 | XBK5 A3+ | 2900 | RX3 | | |

BORILE

| | | | | | | | | | |
|---|--------|------|---|------|----------|------|-----|--|--|
| B | 500 CR | 02 - | 1 | 2247 | XBK5 A3+ | 2353 | RX3 | | |
| B | 500 MT | 02 - | 1 | 2247 | XBK5 A3+ | 2353 | RX3 | | |

BUELL

| | | | | | | | | | |
|--------|----------------------|---------|---|------|----------|------|-----|--|--|
| | All models | 94 - 97 | 1 | 2369 | A3+ | 2306 | RX3 | | |
| | 500 Blast | 01 - | 1 | 2256 | XBK5 A3+ | 2298 | RX3 | | |
| XB-9R | 984 Firebolt | 02 - | 1 | 1139 | A3+ | 2298 | RX3 | | |
| XB-9S | 984 Lightning | 03 - | 1 | 1139 | A3+ | 2298 | RX3 | | |
| XB-9SX | 984 Lightning City X | 04 - | 1 | 1139 | A3+ | 2298 | RX3 | | |
| M2 | 1200 Cyclone | 94 - 97 | 1 | 2369 | A3+ | 2298 | RX3 | | |
| M2 | 1200 Cyclone | 98 - 02 | 1 | 2899 | XBK5 A3+ | 2472 | RX3 | | |
| RS | 1200 | | 1 | 2369 | A3+ | 2306 | RX3 | | |
| S1 | 1200 Lightning | 94 - 97 | 1 | 2369 | A3+ | 2298 | RX3 | | |
| S1 | 1200 Lightning | 98 - 02 | 1 | 2899 | XBK5 A3+ | 2472 | RX3 | | |
| S1 | 1200 Whitelighting | 98 - 02 | 1 | 2899 | XBK5 A3+ | 2472 | RX3 | | |
| S3 | 1200 Thunderbolt | 94 - 97 | 1 | 2369 | A3+ | 2298 | RX3 | | |

1 - 2 - 4 = Nombre de jeux / Number of sets / Anzahl Sets Numero blister / Numero des juegos

L = Gauche / Left / Links / Sinistra / Izquierda

R = Droite / Right / Rechts / Destra / Derecha

BUELL

| S3 | 1200 Thunderbolt | 98 - 02 | 1 | 2899 | XBK5 | A3+ | 2472 | FX3 | |
|----------|---------------------|---------|---|------|------|-----|------|-----|--|
| S3T | 1200 Thunderbolt | 94 - 97 | 1 | 2369 | A3+ | | 2298 | FX3 | |
| S3T | 1200 Thunderbolt | 98 - 02 | 1 | 2899 | XBK5 | A3+ | 2298 | FX3 | |
| X1 | 1200 Lightning | 98 - 02 | 1 | 2899 | XBK5 | A3+ | 2298 | FX3 | |
| XB-12R | 1200 Firebolt | 04 - 08 | 1 | 1139 | A3+ | | 2298 | FX3 | |
| XB-12R | 1200 Firebolt | 09 - | 1 | NA | | | 2298 | FX3 | |
| XB-12S | 1200 Lightning | 04 - 08 | 1 | 1139 | A3+ | | 2298 | FX3 | |
| XB-12Scg | 1200 Lightning | 06 - 08 | 1 | 1139 | A3+ | | 2298 | FX3 | |
| XB-12Scg | 1200 Lightning | 09 - | 1 | NA | | | 2298 | FX3 | |
| XB-12Ss | 1200 Lightning Long | 06 - 08 | 1 | 1139 | A3+ | | 2298 | FX3 | |
| XB-12Ss | 1200 Lightning Long | 09 - | 1 | NA | | | 2298 | FX3 | |
| XB-12STT | 1200 Supet TT | 07 - | 1 | 1139 | A3+ | | 2298 | FX3 | |
| XB-12X | 1200 Ulysses | 06 - | 1 | 1139 | A3+ | | 2298 | FX3 | |

CAGIVA

| WMX | 50 | 89 - | 1 | 2400 | A3+ | S4 | 2472 | FX3 | |
|-----|--------------------|---------|------|------|------|------|------|-----|--|
| | 50 Blues | 89 | 1 | 2794 | A3+ | S4 | 1089 | FX3 | |
| | 50 Cocis | 89 | 1 | 2249 | A3+ | S4 | 2249 | FX3 | |
| | 50 Cocis | 88 - | 1 | 2249 | A3+ | S4 | 1089 | FX3 | |
| | 50 Lucky Explorer | 88 - | 1 | 2249 | A3+ | S4 | 1089 | FX3 | |
| | 50 Mito | 98 - | 1 | 2621 | S4 | | 2377 | FX3 | |
| | 50 Prima | 92 | 1 | 2249 | A3+ | S4 | 2249 | FX3 | |
| | 50 Prima | 93 - | 1 | 2601 | S4 | | 2260 | S4 | |
| | 50 Supercity | 92 | 1 | 2249 | A3+ | S4 | 2249 | FX3 | |
| | 50 Supercity | 93 - | 1 | 2400 | A3+ | S4 | 2249 | FX3 | |
| | 50 W4 | 92 | 1 | 2249 | A3+ | S4 | 2249 | FX3 | |
| LR | 80 | 83 - | 1 | 2249 | A3+ | S4 | T | | |
| SST | 80 | 83 - | 1 | 2249 | A3+ | S4 | T | | |
| SXT | 80 | 83 - | 1 | 2249 | A3+ | S4 | T | | |
| | 80 Cocis | 91 - | 1 | 2249 | A3+ | S4 | 1089 | FX3 | |
| | 80 Prima | 92 - | 1 | 2601 | S4 | | 2260 | S4 | |
| | 80 Super City | 92 - 93 | 1 | 2249 | A3+ | S4 | 2249 | FX3 | |
| | 80 Super City | 94 - | 1 | 2400 | A3+ | S4 | 2249 | FX3 | |
| | 80 W4 | 92 - | 1 | 2249 | A3+ | S4 | 2249 | FX3 | |
| | 110 Passing | 94 - | 1 | 2288 | A3+ | S4 | T | | |
| | 116 Stella | 97 - | 1 | 2621 | A3+ | S4 | T | | |
| | 125 Aletta Electra | 87 - | 1 | 2249 | A3+ | S4 | T | | |
| | 125 Aletta Oro | 86 - | 1 | 2249 | A3+ | S4 | 2249 | FX3 | |
| | 125 Blues | 92 - 95 | 1 | 2794 | A3+ | S4 | 2249 | FX3 | |
| | 125 Cruiser | 87 | 1 | 2400 | A3+ | S4 | 1089 | FX3 | |
| | 125 Dakar | 86 | 1 | 2249 | A3+ | S4 | T | | |
| | 125 Elefant re | 87 - | 1 | 2249 | A3+ | S4 | T | | |
| | 125 Freccia | 89 | 1 | 2400 | A3+ | S4 | 2249 | FX3 | |
| | 125 Freccia C12 R | 91 - | 1 | 2400 | A3+ | | 2249 | FX3 | |
| | 125 Mito | 93 - | 1 | 2247 | A3+ | S4 | 2249 | FX3 | |
| | 125 Mito EV / SP | 95 - | 1 | 2247 | A3+ | S4 | 2249 | FX3 | |
| | 125 Mito Racer | 91 - 92 | 1 | 2400 | A3+ | | 2249 | FX3 | |
| | 125 N1 | 97 - | 1 | 2400 | A3+ | S4 | 2249 | FX3 | |
| | 125 N90 | 91 - | 1 | 2400 | A3+ | S4 | 1089 | FX3 | |
| | 125 Planet | 98 - 02 | 1 | 2247 | A3+ | S4 | 2249 | FX3 | |
| | 125 Raptor | 03 - | 1 | 2247 | A3+ | S4 | 2249 | FX3 | |
| | 125 Roadster | 94 - | 1 | 2794 | A3+ | S4 | T | | |
| | 125 Supercity | 92 - 95 | 1 | 2400 | A3+ | S4 | 2249 | FX3 | |
| | 125 Supercity | 98 - | 1 | 2400 | A3+ | | 2249 | FX3 | |
| | 125 Tamanaco | 88 - 89 | 1 | 2400 | A3+ | S4 | 1089 | FX3 | |
| W8 | 125 | 92 - | 1 | 2249 | A3+ | S4 | 2249 | FX3 | |
| K7 | 125 | 91 - | 1 | 2400 | A3+ | S4 | 2249 | FX3 | |
| | 200 Elefant | 86 - | 1 | 2249 | A3+ | S4 | T | | |
| | 200 Roadster | 96 - | 1 | 2794 | A3+ | S4 | T | | |
| SST | 250 Ala Verde | 81 - | 1 | 2249 | A3+ | S4 | T | | |
| | 350 W 12 | 92 - | 1 | 2400 | A3+ | | 2249 | FX3 | |
| | 350 Alazzurra | 85 - | 1 | 2249 | A3+ | | 2249 | FX3 | |
| | 350 Elefant | 86 - | 1 | 2801 | A3+ | S4 | 2249 | FX3 | |
| SST | 350 Ala Verde | 81 - | 1 | 2249 | A3+ | | T | | |
| SST | 350 | 83 - | 1 | 2249 | A3+ | | T | | |
| SXT | 350 Ala Rossa | 82 - | 1 | 2249 | A3+ | | T | | |
| T4 | 350 E | 87 - | 1 | 2249 | A3+ | | T | | |
| T4 | 350 R | 87 - | 1 | 2249 | A3+ | | T | | |
| MXR | 400 | 82 - | 1 | 2249 | A3+ | | T | | |
| | 500 Canyon | 99 - | 1 | 2288 | A3+ | | 2326 | FX3 | |
| | 500 Mito | 07 | 1 | 2247 | XBK5 | A3+ | 2249 | FX3 | |
| | 500 River | 00 - | 1 | 2247 | A3+ | S4 | 2249 | FX3 | |
| MXR | 500 | 82 - | 1 | 2249 | A3+ | | T | | |
| T4 | 500 E | 87 - | 1 | 2249 | A3+ | | T | | |
| SP | 525 Mito | 08 - | 1 | 2247 | XBK5 | A3+ | 2249 | FX3 | |
| | 600 Canyon | 96 | 1 | 2288 | A3+ | | 2326 | FX3 | |
| | 600 River | 94 - 95 | 1 | 2247 | A3+ | | 2249 | FX3 | |
| | 600 W16 | 95 - | 1 | 2400 | A3+ | | 2306 | FX3 | |
| | 650 Alazzurra | 1 | 2249 | A3+ | | 2249 | FX3 | | |

CAGIVA

| | 650 Elefant | 86 - | 1 | 2801 | A3+ | | 2249 | FX3 | |
|---|--------------------|---------|---|--------|------|-----|------|-----|--|
| | 650 Raptor | 01 - | 2 | 2539 | XBK5 | A3+ | 2827 | FX3 | |
| | 650 V-Raptor | 01 - | 2 | 2539 | XBK5 | A3+ | 2827 | FX3 | |
| | 750 Elefant | 88 | 1 | 2249 | A3+ | | 2249 | FX3 | |
| | 750 Elefant | 94 - 95 | 1 | 2310 | A3+ | | 2352 | FX3 | |
| | 750 Lucky Explorer | 88 | 1 | 2801 | A3+ | | 2249 | FX3 | |
| E | 750 | 96 - | 2 | 2352 | A3+ | | 2352 | FX3 | |
| | 900 Elefant | 90 - 92 | 1 | 2248 | A3+ | | 2326 | FX3 | |
| | 900 Elefant | 93 - 95 | 1 | 2352 | A3+ | | 2352 | FX3 | |
| | 900 E.I Canyon | 98 | 1 | L 2288 | A3+ | | 2326 | FX3 | |
| | 900 E.I Canyon | 98 | 1 | R 2326 | A3+ | | | | |
| | 900 Gran Canyon | 99 - | 2 | 2256 | A3+ | | 2326 | FX3 | |
| E | 900 | 96 - | 2 | 2352 | A3+ | | 2352 | FX3 | |
| | 1000 Navigator | 00 - | 2 | 2256 | XBK5 | A3+ | 2326 | FX3 | |
| | 1000 Raptor | 00 - | 2 | 2539 | XBK5 | A3+ | 2827 | FX3 | |
| | 1000 V-Raptor | 00 - | 2 | 2539 | XBK5 | A3+ | 2827 | FX3 | |
| | 1000 Xtra Raptor | 02 - | 2 | 2539 | XBK5 | A3+ | 2827 | FX3 | |
| | 1000 X-Raptor | 03 - | 2 | 1033 | XBK5 | A3+ | 2827 | FX3 | |
| | 1000 X3 Raptor | 04 - | 2 | 1033 | XBK5 | A3+ | 2827 | FX3 | |

CANNONDALE

| | | | | | | | | | |
|---|--------|------|---|------|------|-----|------|-----|--|
| S | 440 SM | 03 - | 1 | 2247 | XBK5 | A3+ | 2299 | FX3 | |
|---|--------|------|---|------|------|-----|------|-----|--|

CCM

| | | | | | | | | | |
|--|------------------|---------|---|------|------|-----|------|-----|--|
| | 604 DS Supermoto | 99 - 01 | 1 | 2352 | XBK5 | A3+ | 2353 | FX3 | |
| | 604 RS Roadster | 01 | 1 | 2352 | XBK5 | A3+ | 2353 | FX3 | |
| | 644 DS Supermoto | 02 - | 1 | 2352 | XBK5 | A3+ | 2353 | FX3 | |
| | 644 RC 30 | 02 - | 1 | 2352 | XBK5 | A3+ | 2353 | FX3 | |

CPI

| | | | | | | | | | |
|--|---------------------------|------|---|------|-----|----|------|-----|--|
| | 50 Supermoto / Supercross | 03 - | 1 | 2377 | S4 | | 2377 | FX3 | |
| | 125 Sahel | 02 - | 1 | 2300 | A3+ | S4 | 2314 | FX3 | |
| | 125 Supermoto | 07 - | 1 | 2377 | A3+ | S4 | 2377 | FX3 | |

CZ

| | | | | | | | | | |
|--|-----|------|---|------|-----|----|--|--|--|
| | 180 | 93 - | 1 | 2332 | A3+ | S4 | | | |
|--|-----|------|---|------|-----|----|--|--|--|

DAELIM

| | | | | | | | | | |
|----|---------------|---------|---|------|-----|----|------|-----|--|
| | 100 Altino | 98 - | 1 | 2408 | A3+ | S4 | T | | |
| | 125 Altino | 02 - | 1 | 2408 | A3+ | S4 | T | | |
| | 125 Magna | 97 - | 1 | 2313 | A3+ | S4 | T | | |
| | 125 Roadwin | 04 - | 1 | 2313 | A3+ | S4 | 2326 | FX3 | |
| | 125 Rocket | 99 - | 1 | 2313 | A3+ | S4 | T | | |
| NF | 125 | 03 - | 1 | 2408 | A3+ | S4 | T | | |
| VL | 125 Daystar | 00 - | 1 | 2313 | A3+ | S4 | T | | |
| VS | 125 | 98 - | 1 | 2408 | A3+ | S4 | T | | |
| VT | 125 Evolution | 00 - 01 | 1 | 2313 | A3+ | S4 | T | | |
| | 250 Roadwin | 08 - | 1 | 2313 | A3+ | S4 | 2326 | FX3 | |

DERBI

| | | | | | | | | | |
|-----|-------------------------|------|---|------|------|-----|------|-----|--|
| FD | Yumbo | 84 - | 1 | 2377 | A3+ | S4 | T | | |
| FD | Yumbo Extra | 87 - | 1 | 2377 | A3+ | S4 | T | | |
| FDS | | 87 - | 1 | 2377 | A3+ | S4 | T | | |
| FDT | Coppa | 85 | 1 | 2377 | A3+ | S4 | T | | |
| FDT | | 87 - | 1 | 2377 | A3+ | S4 | T | | |
| | 75 GPR | 89 | 1 | 2260 | S4 | | 2377 | FX3 | |
| | 75 Sport Coppa | 84 - | 1 | 2377 | S4 | | T | | |
| | 75 GPR Sport | 84 - | 1 | 2260 | S4 | | 2377 | FX3 | |
| | 80 GPR Cup | 04 - | 1 | NA | S4 | | 2377 | FX3 | |
| | 125 GPR | 05 - | 1 | NA | | | 2377 | FX3 | |
| | 125 GPR Nude | 05 - | 1 | NA | | | 2377 | FX3 | |
| | 125 GPR Racing | 05 - | 1 | NA | | | 2377 | FX3 | |
| | 125 Mulhacén | 07 | 1 | 1146 | S4 | | 2249 | FX3 | |
| | 125 Senda X-Treme SM 4T | 04 - | 1 | 1146 | S4 | | 2377 | FX3 | |
| | 125 Terra | 07 | 1 | 2377 | A3+ | S4 | 2249 | FX3 | |
| | 250 RC | 85 | 1 | 2249 | A3+ | S4 | T | | |
| | 659 Mulhacén | 05 | 1 | 1110 | XBK5 | A3+ | 2827 | FX3 | |
| | 659 Mulhacén | 06 - | 1 | 1033 | XBK5 | A3+ | 2827 | FX3 | |
| | 659 Mulhacén Cafe | | | | | | | | |

GAS GAS

| | | | | | | | | | |
|----|-----|-----|---------|---|-------------|------|-----|-------------|-----|
| SM | 450 | fse | 03 - 06 | 1 | 2247 | XBK5 | A3+ | 2314 | FX3 |
| SM | 450 | fsr | 07 - | 1 | 2247 | XBK5 | A3+ | 2314 | FX3 |

GILERA

| | | | | | | | | | |
|-----|-----|------------------|---------|---|-------------|------|-----|-------------|-----|
| SP | 01 | | 90 - | 1 | 2398 | A3+ | | 2249 | FX3 |
| RC | 50 | Top Rally | 90 | 1 | 2249 | A3+ | S4 | 2249 | FX3 |
| RI | 50 | | 91 - | 1 | 2249 | A3+ | S4 | T | |
| RK | 50 | | 96 - | 1 | 2249 | A3+ | S4 | 2249 | FX3 |
| | 50 | Rally | 87 - | 1 | 2249 | A3+ | S4 | T | |
| | 50 | Sioux | 92 | 1 | 2249 | A3+ | S4 | 2249 | FX3 |
| | 125 | Apache | 91 - | 1 | 2400 | A3+ | S4 | 2284 | FX3 |
| | 125 | Cougar | 99 - | 1 | 2794 | A3+ | S4 | T | |
| | 125 | Crono | 92 - | 1 | 2398 | A3+ | | 2249 | FX3 |
| | 125 | CX | 91 - | 1 | 2398 | A3+ | | 2249 | FX3 |
| | 125 | Fast Bike | 88 - | 1 | 2794 | A3+ | S4 | 2249 | FX3 |
| | 125 | Freestyle | 92 - | 1 | 2398 | A3+ | | 2249 | FX3 |
| | 125 | GSM | 00 - | 1 | 2377 | A3+ | S4 | 2377 | FX3 |
| | 125 | HX / HE | 83 | 1 | 2249 | A3+ | S4 | T | |
| | 125 | KK / KR / KZ | 86 - | 1 | 2794 | A3+ | S4 | 2249 | FX3 |
| | 125 | MX1 / MXR | 89 - | 1 | 2398 | A3+ | | 2249 | FX3 |
| | 125 | R1 / R1S | 90 - | 1 | 2794 | A3+ | S4 | 2249 | FX3 |
| | 125 | SP 01 | 90 | 1 | 2398 | A3+ | | 2249 | FX3 |
| | 125 | SP 02 | 90 - | 1 | 2398 | A3+ | | 2249 | FX3 |
| ER | 125 | Rally | 87 | 1 | 2794 | A3+ | S4 | T | |
| MXR | 125 | | 90 | 1 | 2794 | A3+ | S4 | 2249 | FX3 |
| RC | 125 | Top Rally | 90 - | 1 | 2400 | A3+ | S4 | 2284 | FX3 |
| RRT | 125 | Nebraska | 87 | 1 | 2794 | A3+ | S4 | T | |
| RTX | 125 | | 86 | 1 | 2794 | A3+ | S4 | T | |
| RX | 125 | Arizona Hawk | 85 | 1 | 2794 | A3+ | S4 | T | |
| RX | 125 | Arizona Hawk | 86 - | 1 | 2249 | A3+ | S4 | T | |
| RX | 125 | | 83 | 1 | 2249 | A3+ | S4 | T | |
| X 1 | 125 | | 89 | 1 | 2794 | A3+ | S4 | 1089 | FX3 |
| XR2 | 125 | | 90 | 1 | 2794 | A3+ | S4 | 2249 | FX3 |
| | 200 | Arizona Hawk | 85 | 1 | 2794 | A3+ | S4 | T | |
| | 200 | ER | 87 | 1 | 2794 | A3+ | S4 | T | |
| | 200 | Fast Bike | 87 - | 1 | 2794 | A3+ | S4 | 2249 | FX3 |
| RV | 200 | | 85 - 86 | 2 | NA | | | 2249 | FX3 |
| RX | 200 | | 83 | 1 | 2249 | A3+ | S4 | T | |
| | 250 | Arizona Hawk | 86 - | 1 | 2249 | A3+ | S4 | T | |
| | 250 | Arizona Rally | 86 - | 1 | 2249 | A3+ | S4 | NA | |
| NGR | 250 | | 85 - | 2 | NA | | | 2249 | FX3 |
| | 350 | Dakota | 85 - | 1 | 2794 | A3+ | | T | |
| | 350 | Saturno Bialbero | 90 - | 1 | 2247 | A3+ | | 2249 | FX3 |
| XRT | 350 | | 90 - | 1 | 2794 | A3+ | | 2249 | FX3 |
| | 500 | Dakota | 86 | 1 | 2794 | A3+ | | T | |
| | 500 | Saturno Bialbero | 90 - | 1 | 2247 | A3+ | | 2249 | FX3 |
| | 500 | Saturno Piuma | 90 - | 1 | 2247 | A3+ | | 2249 | FX3 |
| | 600 | Nordwest | 91 - | 2 | 2398 | XBK5 | A3+ | 2249 | FX3 |
| | 600 | Supersport | 03 - | 2 | 1033 | XBK5 | A3+ | 2827 | FX3 |
| RC | 600 | Top Rally | 90 - | 1 | 2400 | A3+ | | 2284 | FX3 |
| RC | 600 | | 88 | 1 | 2794 | A3+ | | 2249 | FX3 |
| XRT | 600 | | 89 | 1 | 2794 | A3+ | | 2249 | FX3 |

HARLEY DAVIDSON

| | | | | | | | | | |
|------|------|--------------------------|---------|---|-------------|-----|--|-------------|-----|
| XL | 883 | Sportster C Custom | 04 - 05 | 1 | 1149 | A3+ | | 1150 | FX3 |
| XL | 883 | Sportster C Custom | 06 - | 1 | 1149 | A3+ | | 1150 | FX3 |
| XL | 883 | Sportster Custom | 00 - 03 | 1 | 2958 | A3+ | | 2958 | FX3 |
| XL | 883 | Sportster L Low | 04 - 05 | 1 | 1149 | A3+ | | 1150 | FX3 |
| XL | 883 | Sportster L Low | 06 - | 1 | 1149 | A3+ | | 1150 | FX3 |
| XL | 883 | Sportster R Roadster | 00 - 03 | 2 | 2958 | A3+ | | 2958 | FX3 |
| XL | 883 | Sportster R Roadster | 04 - 05 | 2 | 1149 | A3+ | | 1150 | FX3 |
| XL | 883 | Sportster R Roadster | 06 - | 2 | 1149 | A3+ | | 1150 | FX3 |
| XL | 883 | Sportster Standard | 04 - 05 | 1 | 1149 | A3+ | | 1150 | FX3 |
| XL | 883 | Sportster Standard | 06 - | 1 | 1149 | A3+ | | 1150 | FX3 |
| XLH | 883 | | 70 - 83 | 1 | 2700 | A3+ | | 2718 | FX3 |
| XLH | 883 | Sportster | 85 - 86 | 1 | 2699 | A3+ | | 2701 | FX3 |
| XLH | 883 | Sportster | 87 - 89 | 1 | 2699 | A3+ | | 2370 | FX3 |
| XLH | 883 | Sportster | 90 - 99 | 1 | 2699 | A3+ | | 2370 | FX3 |
| XLH | 883 | Sportster | 00 - 03 | 1 | 2958 | A3+ | | 2958 | FX3 |
| XLH | 883 | Sportster Hugger | 00 - 03 | 1 | 2958 | A3+ | | 2958 | FX3 |
| XLH | 883 | Sportster R "Flat Track" | 00 - 03 | 1 | 2958 | A3+ | | 2958 | FX3 |
| XL | 1000 | | 78 | 1 | 2700 | A3+ | | 2718 | FX3 |
| XLCH | 1000 | | 78 - 80 | 1 | 2700 | A3+ | | 2718 | FX3 |
| XLH | 1000 | Roadster | 83 - 85 | 2 | 2700 | A3+ | | 2701 | FX3 |
| XLH | 1000 | Sportster | 79 - 82 | 2 | 2700 | A3+ | | 2718 | FX3 |
| XLH | 1000 | Sportster | 83 - 85 | 2 | 2700 | A3+ | | 2701 | FX3 |
| XLS | 1000 | Anniversary | 82 | 2 | 2700 | A3+ | | 2701 | FX3 |
| XLS | 1000 | Roadster | 79 - 82 | 2 | 2700 | A3+ | | 2718 | FX3 |
| XLS | 1000 | Sportster | 83 | 2 | 2700 | A3+ | | 2701 | FX3 |

HARLEY DAVIDSON

| | | | | | | | | | |
|--------|------|------------------------|---------|---|-------------|------|-----|-------------|-----|
| XLX | 1000 | 61 | 83 | 2 | 2700 | A3+ | | 2701 | FX3 |
| XLX | 1000 | 61 | 84 | 1 | 2700 | A3+ | | 2701 | FX3 |
| XR | 1000 | | 85 | 2 | 2700 | A3+ | | 2701 | FX3 |
| XLH | 1100 | | 87 - 88 | 1 | 2699 | A3+ | | 2370 | FX3 |
| XLH | 1100 | Sportster | 85 - 86 | 1 | 2699 | A3+ | | 2701 | FX3 |
| XLX | 1100 | | 86 | 1 | 2699 | A3+ | | 2701 | FX3 |
| VRSCA | 1130 | V-Rod | 02 - 05 | 2 | 2958 | A3+ | | 2958 | FX3 |
| VRSCF | 1130 | Muscle | 09 - | 1 | 1172 | A3+ | | 1172 | FX3 |
| VRSCA | 1130 | V-Rod | 06 - | 2 | 1172 | A3+ | | 1172 | FX3 |
| VRSCAW | 1130 | V-Rod | 08 - | 2 | 1172 | A3+ | | 1172 | FX3 |
| VRSCB | 1130 | V-Rod | 04 - 05 | 2 | 2958 | A3+ | | 2958 | FX3 |
| VRSCD | 1130 | Night Rod | 06 - | 2 | 1172 | A3+ | | 1172 | FX3 |
| VRSCX | 1130 | V-rod | 08 - | 2 | 1172 | A3+ | | 1172 | FX3 |
| VRSCDX | 1130 | Night Rod Special | 06 - | 2 | 1172 | A3+ | | 1172 | FX3 |
| VRSCR | 1130 | Street Rod | 06 - | 2 | 1172 | A3+ | | 1172 | FX3 |
| FL | 1200 | FLH Police | 75 - 79 | 1 | 2599 | A3+ | | 2599 | FX3 |
| FLH | 1200 | Anniversary | 78 | 1 | 2599 | A3+ | | 2599 | FX3 |
| FLH | 1200 | Touring | 77 - 78 | 1 | 2599 | A3+ | | 2599 | FX3 |
| FLH | 1200 | | 80 | 1 | 2599 | A3+ | | 2702 | FX3 |
| FLH | 1200 | | 74 - 76 | 1 | 2599 | A3+ | | 2599 | FX3 |
| FLHS | 1200 | | 77 - 80 | 1 | 2599 | A3+ | | 2599 | FX3 |
| FX | 1200 | | 74 - 80 | 1 | 2700 | A3+ | | 2599 | FX3 |
| FXE | 1200 | | 74 - 80 | 1 | 2700 | A3+ | | 2599 | FX3 |
| FXS | 1200 | | 78 - 79 | 1 | 2700 | A3+ | | 2599 | FX3 |
| XL | 1200 | Sportster C Custom | 00 - 03 | 1 | 2958 | A3+ | | 2958 | FX3 |
| XL | 1200 | Sportster C Custom | 04 - | 1 | 1149 | A3+ | | 1150 | FX3 |
| XL | 1200 | Sportster L Low | 06 - | 1 | 1149 | A3+ | | 1150 | FX3 |
| XL | 1200 | N Nightster | 06 - | 1 | 1149 | A3+ | | 1150 | FX3 |
| XL | 1200 | Sportster R Roadster | 04 - | 2 | 1149 | A3+ | | 1150 | FX3 |
| XL | 1200 | Sportster Custom | 00 - 03 | 1 | 2958 | A3+ | | 2958 | FX3 |
| XL | 1200 | Sportster S Sport | 00 - 03 | 1 | 2958 | A3+ | | 2958 | FX3 |
| XLH | 1200 | Series | 88 | 2 | 2699 | A3+ | | 2370 | FX3 |
| XLH | 1200 | Sportster | 90 - 99 | 1 | 2699 | A3+ | | 2370 | FX3 |
| XLH | 1200 | Sportster | 00 - 03 | 1 | 2958 | A3+ | | 2958 | FX3 |
| XR | 1200 | | 08 - | 2 | 2711 | XBK5 | A3+ | 1150 | FX3 |
| FLH | 1340 | 80 | 78 - 80 | 1 | 2599 | A3+ | | 2599 | FX3 |
| FLH | 1340 | 80 | 81 | 1 | 2599 | A3+ | | 2702 | FX3 |
| FLH | 1340 | Classic | 82 - 83 | 1 | 2718 | A3+ | | 2702 | FX3 |
| FLH | 1340 | Electra Glide | 82 - 83 | 1 | 2718 | A3+ | | 2599 | FX3 |
| FLH | 1340 | Electra Glide Speciale | 84 | 1 | 2599 | A3+ | | 2702 | FX3 |
| FLH | 1340 | Heritage | 81 | 1 | 2718 | A3+ | | 2702 | FX3 |
| FLHS | 1340 | Electra Glide Sport | 90 | 2 | 2699 | A3+ | | 2342 | FX3 |
| FLHT | 1340 | Electra Glide | 85 - 86 | 2 | 2699 | A3+ | | 2701 | FX3 |
| FLHT | 1340 | Electra Glide Classic | 87 - 99 | 2 | 2699 | A3+ | | 2370 | FX3 |
| FLHTC | 1340 | Electra Glide Classic | 85 - 86 | 2 | 2699 | A3+ | | 2701 | FX3 |
| FLHTC | 1340 | Electra Glide Classic | 93 | 2 | 2699 | A3+ | | 2370 | FX3 |
| FLHTC | 1340 | Electra Glide Classic | 90 - 99 | 2 | 2699 | A3+ | | 2342 | FX3 |
| FLHTC | 1340 | Ultra Classic | 90 - 99 | 2 | 2699 | A3+ | | 2342 | FX3 |
| FLST | 1340 | Heritage Softail | 86 - 87 | 1 | 2699 | A3+ | | 2342 | FX3 |
| | | | | | | | | | |

HONDA

| | | | | BEST CHOICE | | OTHER CHOICE | | BEST CHOICE | |
|------|-----------------------|---------|---|-------------|------|--------------|------|-------------|--|
| NSR | 80 R | 93 - | 1 | 2326 | A3+ | S4 | 2314 | FX3 | |
| CA | 125 Rebel | 95 - 96 | 1 | 2288 | A3+ | S4 | T | | |
| CA | 125 Rebel | 97 - | 1 | 2794 | A3+ | S4 | T | | |
| CB | 125 RS | 83 - | 1 | 2408 | A3+ | S4 | T | | |
| CB | 125 T Superdream | 82 - | 1 | 2382 | A3+ | S4 | T | | |
| CB | 125 TDC | 83 - 89 | 1 | 2289 | A3+ | S4 | T | | |
| CB | 125 TT | 90 | 1 | 2248 | A3+ | S4 | T | | |
| CBF | 125 | 09 - | 1 | 1148 | A3+ | | T | | |
| CBR | 125 R | 04 - | 1 | 1148 | XBK5 | A3+ | 1067 | FX3 | |
| CBX | 125 Custom | 88 | 1 | 2621 | A3+ | S4 | T | | |
| CBX | 125 F | 84 - 88 | 1 | 2382 | A3+ | S4 | T | | |
| CG | 125 | 04 - | 1 | 2408 | A3+ | S4 | T | | |
| CLR | 125 CityFly | 98 - | 1 | 2794 | A3+ | S4 | T | | |
| CRM | 125 / R | 90 - 98 | 1 | 2794 | A3+ | S4 | 2249 | FX3 | |
| MBX | 125 RWB | 84 - | 1 | 2621 | A3+ | S4 | T | | |
| MT | 125 R | 78 - | 1 | 2814 | A3+ | S4 | T | | |
| MTX | 125 Camel (Italy) | 88 - | 1 | 2794 | A3+ | S4 | T | | |
| MTX | 125 R | 84 - 95 | 1 | 2451 | A3+ | S4 | T | | |
| MTX | 125 R (Italy) | 86 | 1 | 2794 | A3+ | S4 | T | | |
| NS | 125 (Italy) | 85 - 88 | 1 | 2794 | A3+ | S4 | T | | |
| NS | 125 | 89 | 1 | 2245 | A3+ | S4 | 2287 | FX3 | |
| NSR | 125 F | 88 - 89 | 1 | 2451 | A3+ | S4 | T | | |
| NSR | 125 F / R | 90 - 92 | 1 | 2794 | A3+ | S4 | 2249 | FX3 | |
| NSR | 125 R (Italy) | 89 - | 1 | 2794 | A3+ | S4 | 2249 | FX3 | |
| NX | 125 Transcity | 90 - 98 | 1 | 2794 | A3+ | S4 | T | | |
| RS | 125 R | 91 - 94 | 1 | 2256 | XBK5 | A3+ | 2287 | FX3 | |
| RS | 125 R | 95 - | 1 | 1157 | XBK5 | | 2287 | FX3 | |
| RTV | 125 NRS (Italy) | 87 - | 1 | 2794 | A3+ | S4 | T | | |
| VT | 125 Shadow | 99 - | 1 | 2326 | A3+ | S4 | T | | |
| XL | 125 R | 86 | 1 | 2451 | A3+ | S4 | T | | |
| XL | 125 R / PD / (Italy) | 85 | 1 | 2794 | A3+ | S4 | T | | |
| XL | 125 R / PD / Italy EX | 87 - | 1 | 2794 | A3+ | S4 | T | | |
| XLR | 125 R | 98 - | 1 | 2256 | A3+ | S4 | T | | |
| XLV | 125 Varadero | 01 - | 1 | 2326 | A3+ | S4 | 1067 | FX3 | |
| XR | 125 L | 03 - | 1 | 2300 | A3+ | S4 | T | | |
| CBR | 150 R | 00 - | 1 | 1148 | XBK5 | A3+ | 1067 | FX3 | |
| CG | 150 | 04 - | 1 | 2408 | A3+ | S4 | T | | |
| CRF | 150 F | 03 - | 1 | 2300 | A3+ | S4 | T | | |
| NS | 150 | 92 - | 1 | 2314 | S4 | | T | | |
| NSR | 150 | 02 - | 1 | 2326 | A3+ | S4 | 2288 | FX3 | |
| CTX | 200 | 04 - | 1 | 2300 | A3+ | | T | | |
| MTX | 200 R | 85 - | 1 | 2451 | A3+ | S4 | T | | |
| XL | 200 R / PD / (Italy) | 85 - | 1 | 2794 | A3+ | S4 | T | | |
| SL | 230 | 97 - | 1 | 2300 | A3+ | | 2314 | FX3 | |
| AX-1 | 250 | 90 | 1 | 2302 | A3+ | S4 | NA | NA | |
| CA | 250 Rebel | 90 - | 1 | 2326 | A3+ | S4 | T | | |
| CB | 250 | 88 - 91 | 1 | 2310 | A3+ | | T | | |
| CB | 250 | 92 - 05 | 1 | 2256 | A3+ | S4 | T | | |
| CB | 250 Rebel | 86 - | 1 | 2621 | A3+ | S4 | T | | |
| CB | 250 RS | 85 - | 1 | 2451 | A3+ | S4 | T | | |
| CBF | 250 | 04 - | 1 | 2326 | A3+ | | T | | |
| CBR | 250 F | 86 - | 2 | 2252 | XBK5 | A3+ | T | | |
| CBR | 250 Hurricane | 87 - | 2 | 2252 | XBK5 | A3+ | 2298 | FX3 | |
| CBR | 250 Nighthawk | 92 - | 1 | 2256 | XBK5 | A3+ | T | | |
| CBR | 250 R / RR | 90 | 2 | 2256 | XBK5 | A3+ | 2298 | FX3 | |
| CBR | 250 RJ | 88 | 2 | 2256 | XBK5 | A3+ | 2298 | FX3 | |
| CBX | 250 RSE | 84 - | 1 | 2289 | A3+ | S4 | T | | |
| CBX | 250 S | 88 - | 1 | 2382 | A3+ | S4 | T | | |
| CD | 250 UJ | 88 - 92 | 1 | 2310 | A3+ | | T | | |
| CMX | 250 C Rebel | 96 - | 1 | 2288 | A3+ | S4 | T | | |
| CMX | 250 Rebel | 85 - | 1 | 2621 | A3+ | S4 | T | | |
| CRM | 250 R | 90 - | 1 | 2302 | A3+ | | NA | | |
| FTR | 250 | 86 - | 1 | 2451 | A3+ | S4 | 2451 | FX3 | |
| GB | 250 Clubman | 88 - | 1 | 2289 | A3+ | S4 | T | | |
| NS | 250 R | 85 | 2 | 2382 | A3+ | S4 | 2289 | FX3 | |
| NS | 250 | 89 | 1 | 2245 | A3+ | S4 | 2287 | FX3 | |
| NSR | 250 R | 87 - | 2 | 2252 | XBK5 | A3+ | 2289 | FX3 | |
| NSR | 250 RJ | 88 - | 2 | 2245 | A3+ | S4 | 2298 | FX3 | |
| NSR | 250 R / SP | 90 | 2 | 2245 | A3+ | S4 | 2298 | FX3 | |
| NX | 250 | 88 - 90 | 1 | 2302 | A3+ | S4 | T | | |
| RS | 250 R | 93 - | 2 | 1157 | XBK5 | | 2287 | FX3 | |
| RS | 250 R | 91 - 92 | 2 | 2245 | XBK5 | A3+ | 2298 | FX3 | |
| VT | 250 F | 88 - 90 | 1 | 2252 | XBK5 | A3+ | T | | |
| VT | 250 Spada | 89 | 1 | 2256 | XBK5 | A3+ | 2298 | FX3 | |
| VTR | 250 | 90 | 1 | 2252 | XBK5 | A3+ | T | | |
| VTR | 250 | 98 - | 1 | 2313 | A3+ | | 2298 | FX3 | |
| VTZ | 250 | 88 - | 1 | 2252 | A3+ | | T | | |
| XL | 250 Degree | 91 - | 1 | 2302 | A3+ | S4 | T | | |
| XL | 250 R | 84 - 87 | 1 | 2451 | A3+ | S4 | T | | |

HONDA

| | | | | BEST CHOICE | | OTHER CHOICE | | BEST CHOICE | |
|------|--------------------------|---------|---|-------------|------|--------------|------|-------------|--|
| XLR | 250 R | 88 - | 1 | 2451 | A3+ | S4 | T | | |
| XLR | 250 R Baja | 88 - 90 | 1 | 2302 | A3+ | S4 | NA | | |
| XLR | 250 R SPL | 94 - | 1 | 2300 | A3+ | S4 | 2314 | FX3 | |
| | 250 Steed | 93 - | 1 | 2256 | A3+ | S4 | T | | |
| | 250 | 86 - | 1 | 2621 | A3+ | S4 | | | |
| CB | 350 S. G. | 87 - 90 | 2 | 2252 | A3+ | | T | | |
| NX | 350 | 92 - | 1 | 2252 | A3+ | | T | | |
| XL | 350 R | 84 - 85 | 1 | 2451 | A3+ | S4 | T | | |
| | 400 Xelvis | | 1 | 2289 | A3+ | | 2289 | FX3 | |
| CB | 400 Four | 81 - | 2 | 2289 | A3+ | | T | | |
| CB | 400 Hawk | 81 - | 1 | 2289 | A3+ | | T | | |
| CB | 400 N | 78 - 81 | 1 | 2814 | A3+ | S4 | T | | |
| CB | 400 N | 82 - 85 | 1 | 2289 | A3+ | | T | | |
| CB | 400 N | 86 - | 1 | 2252 | A3+ | | T | | |
| CB | 400 NZ | - 79 | 1 | 2814 | A3+ | S4 | T | | |
| CB | 400 Super Four | 92 - 95 | 2 | 2313 | A3+ | | 2298 | FX3 | |
| CB | 400 Twin | 82 - | 1 | 2289 | A3+ | | T | | |
| CB | 400 | 82 - | 2 | 2289 | A3+ | | 2289 | FX3 | |
| CB-1 | 400 (CB 400 F) | 89 - 90 | 1 | 2256 | A3+ | | 2298 | FX3 | |
| CBR | 400 F / Fil | 85 | 2 | 2289 | A3+ | | 2289 | FX3 | |
| CBR | 400 RR | 87 - | 2 | 2256 | XBK5 | A3+ | 2298 | FX3 | |
| CBR | 400 R | 87 | 2 | 2252 | XBK5 | A3+ | 2289 | FX3 | |
| CBR | 400 R | 88 - 93 | 2 | 2256 | XBK5 | A3+ | 2298 | FX3 | |
| CBR | 400 F | 92 - | 2 | 2252 | XBK5 | A3+ | 2296 | FX3 | |
| CM | 400 C | 81 | 1 | 2382 | A3+ | S4 | T | | |
| CM | 400 T | 82 - | 1 | 2289 | A3+ | | T | | |
| CX | 400 | 81 | 1 | 2814 | A3+ | S4 | T | | |
| GB | 400 TT | 88 - | 1 | 2289 | A3+ | | T | | |
| GL | 400 | 77 - 80 | 1 | 2814 | A3+ | S4 | T | | |
| NS | 400 R | 85 - 87 | 2 | 2382 | A3+ | S4 | 2289 | FX3 | |
| NTV | 400 Bros II | 88 | 1 | 2245 | A3+ | | 2298 | FX3 | |
| NV | 400 Custom | 88 | 1 | NA | | | 2289 | FX3 | |
| RVF | 400 RR (NC35) | 90 - 96 | 2 | 2245 | A3+ | | 2385 | FX3 | |
| VF | 400 Integra | 86 - | 1 | 2382 | A3+ | S4 | 2382 | FX3 | |
| VFR | 400 R NC21 / NC21 Z | 86 - | 2 | 2252 | XBK5 | A3+ | 2252 | FX3 | |
| VFR | 400 R NC24 | 87 - | 2 | 2252 | XBK5 | A3+ | 2385 | FX3 | |
| VFR | 400 R NC30 | 89 - | 2 | 2245 | A3+ | | 2298 | FX3 | |
| VRX | 400 T Roadstar | 95 - | 1 | 2313 | A3+ | | 2298 | FX3 | |
| VTR | 400 R | 90 | 2 | 2245 | A3+ | | 2385 | FX3 | |
| NV | 400 Steed | 88 | 1 | 2310 | A3+ | | T | | |
| NV | 400 Steed | 92 - 93 | 1 | 2256 | A3+ | | T | | |
| XR | 400 Supermotard | 00 - | 1 | 2300 | XBK5 | A3+ | 2314 | FX3 | |
| CB | 450 SC Nighthawk | 83 - 86 | 1 | 2382 | A3+ | S4 | T | | |
| CB | 450 T | 82 - | 1 | 2289 | A3+ | | T | | |
| CB | 450 S | 86 - | 2 | 2252 | A3+ | | T | | |
| CM | 450 A / C | 82 - | 1 | 2289 | A3+ | | T | | |
| CMX | 450 Rebel | 86 - | 1 | 2289 | A3+ | | T | | |
| CB | 500 S | 98 - 03 | 1 | 2396 | XBK5 | A3+ | 2353 | FX3 | |
| CB | 500 | 94 - 96 | 1 | 2256 | XBK5 | A3+ | | | |
| CB | 500 | 97 - 03 | 1 | 2396 | XBK5 | A3+ | 2353 | FX3 | |
| CBF | 500 ABS | 04 - | 1 | 1159 | XBK5 | A3+ | 2296 | FX3 | |
| CBF | 500 | 04 - | 1 | 2256 | XBK5 | A3+ | 2296 | FX3 | |
| CBR | 500 F (Austria) | 87 - 90 | 2 | 2252 | XBK5 | A3+ | 2289 | FX3 | |
| CX | 500 C | 81 - 82 | 2 | 2289 | A3+ | | T | | |
| CX | 500 Euro | 82 - | 2 | 2382 | A3+ | | 2382 | FX3 | |
| CX | 500 Silver W Turbo | 83 - | 2 | 2289 | A3+ | | 2289 | FX3 | |
| CX | 500 Turbo | 82 - | 2 | 2289 | A3+ | | 2382 | FX3 | |
| CX | 500 | 78 - 80 | 1 | 2814 | A3+ | | T | | |
| CX | 500 | 81 - | 2 | 2382 | A3+ | | T | | |
| FT | 500 | 82 - | 2 | 2289 | A3+ | | 2289 | FX3 | |
| GB | 500 TT | 88 - | 1 | 2289 | A3+ | | T | | |
| GL | 500 D | 81 - | 2 | 2289 | A3+ | | T | | |
| GL | 500 I | 81 - 82 | 2 | 2382 | A3+ | | T | | |
| GL | 500 | 82 | 2 | 2382 | A3+ | | 2289 | FX3 | |
| NS | 500 R | 85 - | 2 | 2289 | A3+ | | 2289 | FX3 | |
| NX | 500 Dominator (Austria) | 88 - 92 | 1 | 2248 | A3+ | | 2298 | FX3 | |
| NX | 500 Dominator (Austria) | 93 - 96 | 1 | 2310 | A3+ | | 2298 | FX3 | |
| NX | 500 Dominator (Austria) | 97 - | 1 | 2352 | A3+ | | 2353 | FX3 | |
| VF | 500 F / Fil | 84 - 86 | 2 | 2289 | A3+ | | 2289 | FX3 | |
| VT | 500 C Shadow | 83 - 86 | 1 | 2289 | A3+ | | T | | |
| XBR | 500 S | 85 - | 1 | 2289 | A3+ | | T | | |
| XLR | 500 R | 83 - | 1 | 2451 | A3+ | | T | | |
| CB | 550 SC | 83 - | 1 | 2289 | A3+ | | T | | |
| | 600 Steed | 88 - 91 | 1 | 2310 | A3+ | | T | | |
| | 600 Steed | 92 - | 1 | 2256 | A3+ | | T | | |
| CB | 600 Hornet (Japan model) | 98 - | 2 | 2711 | XBK5 | A3+ | 2296 | FX3 | |
| CB | 600 F Hornet | 98 - 06 | 2 | 2256 | XBK5 | A3+ | 2296 | FX3 | |
| CB | 600 F Hornet S | 00 - | 2 | 2256 | XBK5 | A3+ | 2296 | FX3 | |
| CB | 600 Hornet | 07 - | 2 | 2256 | XBK5 | A3+ | 1174 | FX3 | |

1 - 2 - 4 = Nombre de jeux / Number of sets / Anzahl Sets / Numero blister / Numero de juegos
 L = Gauche / Left / Links / Sinistra / Izquierda
 R = Droite / Right / Rechts / Destra / Derecha
 NA = Non Attribué / Not Available / Nicht verfügbar / Non disponibile / No disponible

BEST CHOICE = Notre meilleur choix / Empfehlung
 Mescola consigliata / Pastilla recomendada
 OTHER CHOICE = Autre possibilité / Weitere Auswahlmöglichkeiten
 Altra mescola / Otra posibilidad

HONDA

| VT | 1100 C2 Shadow | 95 - | 2 | 2256 | XBK5 | A3+ | 2296 | FX3 | |
|-----|------------------------------|-------|---|------|------|-----|------|-----|--|
| VT | 1100 C3 Shadow | 98 - | 1 | 2256 | XBK5 | A3+ | 2296 | FX3 | |
| VT | 1100 T Shadow | 98 - | 1 | 2256 | XBK5 | A3+ | 2296 | FX3 | |
| GL | 1200 A Goldwing | 84 - | 2 | 2289 | A3+ | | 2289 | FX3 | |
| GL | 1200 DX Goldwing | 86 - | 2 | 2289 | A3+ | | 2289 | FX3 | |
| GL | 1200 Goldwing | 84 - | 2 | 2289 | A3+ | | 2289 | FX3 | |
| VRF | 1200 F | 10 - | 2 | 1216 | XBK5 | A3+ | 1217 | FX3 | |
| CB | 1300 X-4 | 97-00 | 2 | 2245 | XBK5 | A3+ | 2813 | FX3 | |
| CB | 1300 SF | 98-00 | 2 | 2899 | XBK5 | A3+ | 2813 | FX3 | |
| CB | 1300 F1 | 01 | 2 | 2711 | XBK5 | A3+ | 2813 | FX3 | |
| CB | 1300 R | 02 - | 2 | 2711 | XBK5 | A3+ | 2813 | FX3 | |
| CB | 1300 Super Four | 03-09 | 2 | 2711 | XBK5 | A3+ | 2296 | FX3 | |
| CB | 1300 Super Four ABS | 05-09 | 2 | 2711 | XBK5 | A3+ | 2296 | FX3 | |
| ST | 1300 Pan European / ABS | 02 - | 2 | 2602 | A3+ | | 2602 | FX3 | |
| VTX | 1300 C / S | 03 - | 1 | 2256 | XBK5 | A3+ | 2296 | FX3 | |
| GL | 1500 Goldwing / SE | 88-93 | 2 | 2248 | A3+ | | 2289 | FX3 | |
| GL | 1500 Goldwing Aspencade SE | 94 - | 2 | 2248 | A3+ | | 2289 | FX3 | |
| GL | 1500 F6C Custom / C Valkyrie | 96-02 | 2 | 2256 | XBK5 | A3+ | 2313 | FX3 | |
| GLX | 1500 | 88 - | 2 | 2248 | A3+ | | 2289 | FX3 | |
| GL | 1800 Goldwing | 01 - | 2 | 2602 | XBK5 | A3+ | 2602 | FX3 | |
| NRX | 1800 Valkyrie Rune | 04 - | 2 | 2602 | XBK5 | A3+ | 2602 | FX3 | |
| VTX | 1800 | 01 - | 2 | 2602 | XBK5 | A3+ | 2602 | FX3 | |

HOREX

| | | | | | | | | | |
|--|---------------|------|---|------|-----|--|------|-----|--|
| | 80 Rebell T | 86 - | 2 | 2332 | A3+ | | 2332 | FX3 | |
| | 80 Sport L | 86 - | 2 | 2332 | A3+ | | 2332 | FX3 | |
| | 125 Imperator | 96 - | 1 | 2332 | A3+ | | T | | |
| | 125 Regent | 96 - | 1 | 2332 | A3+ | | T | | |
| | 560 E | 86 - | 2 | 2332 | A3+ | | 2332 | FX3 | |
| | 600 Columbus | 87 - | 2 | 2332 | A3+ | | 2332 | FX3 | |

HRD

| | | | | | | | | | |
|--|-----------------|-------|---|------|----|--|------|-----|--|
| | 125 Supermotard | 00-02 | 1 | 1144 | S4 | | 2377 | FX3 | |
| | 125 Trail | 00-02 | 1 | 1144 | S4 | | 2377 | FX3 | |

HUSABERG

| | | | | | | | | | |
|----|------------|-------|---|------|------|-----|------|-----|--|
| FS | 400 e/c SM | 01-03 | 1 | 2251 | XBK5 | A3+ | 2353 | FX3 | |
| FS | 450 e/c SM | 04 - | 1 | 2251 | XBK5 | A3+ | 2353 | FX3 | |
| FE | 501 e SM | 00 | 1 | 2352 | XBK5 | A3+ | 2353 | FX3 | |
| FE | 600 e SM | 00 | 1 | 2352 | XBK5 | A3+ | 2353 | FX3 | |
| FS | 650 e/c SM | 01 - | 1 | 2251 | XBK5 | A3+ | 2353 | FX3 | |

HUSQVARNA

| | | | | | | | | | |
|-----|--------------|-------|---|------|------|-----|------|-----|--|
| | 50 Racing | 98 - | 1 | 2377 | A3+ | S4 | T | | |
| SM | 125 S | 00-05 | 1 | 2352 | XBK5 | A3+ | 2353 | FX3 | |
| SM | 125 S | 06 | 1 | 2352 | XBK5 | A3+ | 2353 | FX3 | |
| SM | 125 | 98-99 | 1 | 2352 | XBK5 | A3+ | 2353 | FX3 | |
| WRE | 125 SM | 99 - | 1 | 2352 | XBK5 | A3+ | 2353 | FX3 | |
| SM | 400 R | 02 | 1 | 2247 | XBK5 | A3+ | 2353 | FX3 | |
| SM | 450 R | 03-04 | 1 | 2247 | XBK5 | A3+ | 2353 | FX3 | |
| SM | 450 R | 05 | 1 | 1033 | XBK5 | A3+ | 2353 | FX3 | |
| SM | 450 R / RR | 06-08 | 1 | 1033 | XBK5 | A3+ | 1108 | FX3 | |
| SM | 450 R | 09 - | 1 | 1033 | XBK5 | A3+ | 1108 | FX3 | |
| SM | 510 R | 05 | 1 | 2247 | XBK5 | A3+ | 2353 | FX3 | |
| SM | 510 R | 06 | 1 | 1033 | XBK5 | A3+ | 1108 | FX3 | |
| SM | 570 Nox | 01-03 | 1 | 2539 | XBK5 | A3+ | 2353 | FX3 | |
| SM | 570 R | 01-05 | 1 | 2247 | XBK5 | A3+ | 2353 | FX3 | |
| SM | 570 R | 06 | 1 | 2247 | XBK5 | A3+ | 1108 | FX3 | |
| LT | 610 E | 99 - | 1 | 2539 | XBK5 | A3+ | 2353 | FX3 | |
| SM | 610 SM / SMS | 98 - | 1 | 2539 | XBK5 | A3+ | 2353 | FX3 | |
| SM | 610 | 06 | 1 | 1033 | XBK5 | A3+ | 1108 | FX3 | |
| SM | 630 | 10 - | 1 | 1033 | XBK5 | A3+ | 1108 | FX3 | |
| SMR | 630 | 04-05 | 1 | 2247 | XBK5 | A3+ | 2353 | FX3 | |
| SMR | 630 | 06 - | 1 | 2247 | XBK5 | A3+ | 1108 | FX3 | |
| STR | 650 CRC | 07 - | 1 | 1033 | XBK5 | A3+ | 1108 | FX3 | |

HYOSUNG

| | | | | | | | | | |
|-----|-------------|-------|---|------|-----|----|------|-----|--|
| GT | 125 Comet | 02 - | 1 | 2621 | A3+ | S4 | 2621 | FX3 | |
| GT | 125 Comet R | 06 - | 2 | 2621 | A3+ | S4 | 2621 | FX3 | |
| GV | 125 Aquila | 02-04 | 1 | 2621 | A3+ | S4 | T | | |
| GV | 125 Aquila | 05 - | 1 | 2621 | A3+ | S4 | T | | |
| RT | 125 Karion | 02 - | 1 | 2621 | A3+ | S4 | T | | |
| RX | 125 | 00 - | 1 | 2621 | A3+ | S4 | T | | |
| RX | 125 SM | 07 - | 1 | 2621 | A3+ | S4 | 2621 | FX3 | |
| | 125 V2 | 99 - | 1 | 2256 | A3+ | S4 | | | |
| XRX | 125 SM | 07 - | 1 | 2621 | A3+ | S4 | 2621 | FX3 | |
| XRX | 125 Offroad | 99-06 | 1 | 2621 | A3+ | S4 | T | | |
| GT | 250 Comet | 02 | 1 | 2304 | A3+ | | 2282 | FX3 | |
| GT | 250 Comet | 03 - | 1 | 2621 | A3+ | | 2621 | FX3 | |

HYOSUNG

| | | | | | | | | | |
|-----|------------------------|-------|---|------|------|-----|------|-----|--|
| GT | 250 R | 07 - | 2 | 2621 | A3+ | | 2621 | FX3 | |
| GV | 250 Aquila | 02 - | 1 | 2621 | A3+ | | T | | |
| GA | 300 | 98 - | 1 | 2285 | A3+ | | T | | |
| XRX | 400 | 05 - | 1 | 2621 | A3+ | | 2314 | FX3 | |
| RX | 450 SM | 08 - | 1 | 1033 | XBK5 | A3+ | 2353 | FX3 | |
| GT | 600 Comet | 02 | 1 | 2304 | A3+ | | 2282 | FX3 | |
| GT | 600 Comet | 03 | 2 | 2621 | A3+ | | 2621 | FX3 | |
| GT | 650 Comet | 04 - | 2 | 2621 | A3+ | | 2621 | FX3 | |
| GT | 650 Custom Trendkiller | 07 - | 2 | 2621 | A3+ | | 2621 | FX3 | |
| GT | 650 Comet R / S | 05 - | 2 | 2621 | A3+ | | 2621 | FX3 | |
| GT | 650 TTC | 07 - | 2 | 2621 | A3+ | | 2621 | FX3 | |
| GT | 650 X | 07 - | 2 | 2621 | A3+ | | 2621 | FX3 | |
| GV | 650 Aquila | 04-05 | 2 | 2621 | A3+ | | 1084 | FX3 | |
| GV | 650 Aquila | 06 - | 2 | 2621 | A3+ | | 2621 | FX3 | |
| GV | 700 C | 10 - | 1 | 2621 | A3+ | | 2621 | FX3 | |
| GV | 1000 Cruiser | 06 - | 2 | 2621 | A3+ | | 2621 | FX3 | |

ITALJET

| | | | | | | | | | |
|--|-----------------|------|---|------|------|-----|------|-----|--|
| | 350 Road master | 83 - | 2 | 2249 | A3+ | | T | | |
| | 650 Bazooka | 06 - | 2 | 2621 | A3+ | | 2621 | FX3 | |
| | 650 Griffon | 06 - | 2 | 2621 | A3+ | | 2621 | FX3 | |
| | 900 Griffon | 00 - | 1 | 2247 | XBK5 | A3+ | 2249 | FX3 | |

JIANSHE

| | | | | | | | | | |
|----|-----|------|---|------|-----|----|---|--|--|
| JS | 125 | 02 - | 1 | 2546 | A3+ | S4 | T | | |
|----|-----|------|---|------|-----|----|---|--|--|

JINCHENG

| | | | | | | | | | |
|----|-----------|------|---|------|-----|----|---|--|--|
| JC | 125 2A/3A | 97 - | 1 | 2326 | A3+ | S4 | T | | |
| JC | 150 T-D | 06 - | 1 | 2546 | A3+ | S4 | T | | |
| JC | 250 | 06 - | 1 | 2288 | A3+ | S4 | T | | |

KAWASAKI

| | | | | | | | | | |
|-----|------------------------|-------|---|------|-----|----|------|-----|--|
| AR | 50 | 81-82 | 1 | 2469 | S4 | | T | | |
| KSR | 50 I | 90 - | 1 | 2469 | S4 | | 2469 | S4 | |
| AR | 80 | 81 - | 1 | 2469 | S4 | | T | | |
| KSR | 80 II | 90 - | 1 | 2469 | S4 | | 2469 | S4 | |
| KH | 100 EX | 88 - | 1 | 2306 | A3+ | S4 | T | | |
| KH | 100 GH | 83 - | 1 | 2306 | A3+ | S4 | T | | |
| AR | 125 A1 / A1A / A7 / LC | 82-94 | 1 | 2306 | A3+ | S4 | T | | |
| BN | 125 Eliminator A1 / A2 | 98-99 | 1 | 2408 | A3+ | S4 | T | | |
| BN | 125 Eliminator A3 | 00 - | 1 | 2326 | A3+ | S4 | T | | |
| KE | 125 | 86 - | 1 | 2306 | A3+ | S4 | T | | |
| KH | 125 | 82-98 | 1 | 2306 | A3+ | S4 | T | | |
| KLX | 125 | 10 - | 1 | 2288 | A3+ | S4 | 2408 | S4 | |
| KLX | 125 D-Tracker | 10 - | 1 | 2288 | A3+ | S4 | 2408 | S4 | |
| KMX | 125 | 86 | 1 | 2469 | S4 | | 2306 | FX3 | |
| KMX | 125 | 87-02 | 1 | 2469 | S4 | | 2306 | FX3 | |
| ZL | 125 Eliminator | 97 - | 1 | 2469 | S4 | | T | | |
| KMX | 200 A2 / A3 / A4 | 88-92 | 1 | 2469 | S4 | | 2306 | FX3 | |
| Z | 200 A6 | 83 - | 1 | 2306 | A3+ | S4 | T | | |
| | 250 Estrella | 92 - | 1 | 2306 | A3+ | S4 | 2306 | FX3 | |
| BR | 250 | 86 - | 1 | 2285 | A3+ | S4 | T | | |
| CS | 250 | 86 - | 1 | 2285 | A3+ | S4 | T | | |
| EL | 250 E3 / E4 | 93-94 | 1 | 2285 | A3+ | S4 | T | | |
| EL | 250 Eliminator | 88 - | 1 | 2285 | A3+ | S4 | T | | |
| EL | 250 | 91-96 | 1 | 2285 | A3+ | S4 | T | | |
| EL | 250 | 97 - | 1 | 2285 | A3+ | S4 | T | | |
| EX | 250 R Ninja | 86-87 | 1 | 2285 | A3+ | S4 | 2285 | FX3 | |
| EX | 250 R F2-F17 Ninja | 88-07 | 1 | 2304 | A3+ | | 2389 | FX3 | |
| | 250 R Ninja | 08 - | 1 | 2326 | A3+ | | 2326 | FX3 | |
| GPX | 250 R | 88 - | 2 | 2304 | A3+ | | 2389 | FX3 | |
| GPZ | 250 | 83 - | 2 | 2285 | A3+ | | T | | |
| GPZ | 250 Belt Drive | 83-84 | 1 | 2306 | A3+ | S4 | T | | |
| GPZ | 250 R | 86 - | 1 | 2285 | A3+ | | 2285 | FX3 | |
| KL | 250 D2-D14 (KLR 250) | 85-97 | 1 | 2306 | A3+ | S4 | T | | |
| KL | 250 D12 / D13 | 95-96 | 1 | 2306 | A3+ | S4 | T | | |
| KLX | 250 R | 93-94 | 1 | 2300 | A3+ | S4 | 2299 | FX3 | |
| KLX | 250 ES | 94-97 | 1 | 2300 | A3+ | S4 | 2299 | FX3 | |
| KLX | 250 | 98-03 | 1 | 2300 | A3+ | S4 | 2314 | FX3 | |
| KLX | | | | | | | | | |

KAWASAKI

| | | | | BEST CHOICE | | OTHER CHOICE | | BEST CHOICE | |
|--------|-----------------------------|----------|-----|-------------|----------|--------------|-----|-------------|--|
| ZX10-R | 1000 Ninja (Rad.Cal) | 04 - 07 | 2 | 1110 | XBK5 A3+ | 2381 | FX3 | | |
| ZX10-R | 1000 Ninja (Rad.Cal) | 08 - 10 | 2 | 1133 | XBK5 A3+ | 2381 | FX3 | | |
| ZX10-R | 1000 Ninja (Rad.Cal) | 11 - | 2 | 1133 | XBK5 A3+ | 2381 | FX3 | | |
| GPZ | 1100 | 83 - 94 | 2 | 2285 | A3+ | 2285 | FX3 | | |
| GPZ | 1100 | 95 - 96 | 1 L | 2383 | XBK5 A3+ | 2381 | FX3 | | |
| GPZ | 1100 | 95 - 96 | 1 R | 2384 | XBK5 A3+ | | | | |
| GPZ | 1100 ABS | 97 - | 1 L | 2383 | XBK5 A3+ | 2381 | FX3 | | |
| GPZ | 1100 ABS | 97 - | 1 R | 2384 | XBK5 A3+ | | | | |
| Z | 1100 GP | 83 - 2 | | 2285 | A3+ | 2285 | FX3 | | |
| Z | 1100 LTD | 85 - 2 | | 2285 | A3+ | 2285 | FX3 | | |
| Z | 1100 R LTD | 84 - 2 | | 2285 | A3+ | 2285 | FX3 | | |
| Z | 1100 ST | 81 - 2 | | NA | | 2280 | FX3 | | |
| ZN | 1100 B1 / B1L / LTD | 84 - 2 | | 2285 | A3+ | 2285 | FX3 | | |
| ZR | 1100 Zephyr | 92 - 96 | 2 | 2251 | XBK5 A3+ | 2304 | FX3 | | |
| ZR | 1100 Zephyr | 97 - | 1 L | 2383 | XBK5 A3+ | 2304 | FX3 | | |
| ZR | 1100 Zephyr | 97 - | 1 R | 2384 | XBK5 A3+ | | | | |
| ZRX | 1100 | 96 - 00 | 2 | 2255 | XBK5 A3+ | 2282 | FX3 | | |
| ZX | 1100 A1 / GP | 83 - 2 | | 2285 | A3+ | 2285 | FX3 | | |
| ZX | 1100 D1-D4 ZX 11 | 93 - 97 | 2 | 2251 | XBK5 A3+ | 2282 | FX3 | | |
| ZZR | 1100 | 90 - 93 | 2 | 2251 | XBK5 A3+ | 2304 | FX3 | | |
| ZZR | 1100 | 94 - 01 | 2 | 2251 | XBK5 A3+ | 2282 | FX3 | | |
| ZG | 1200 B1-B10 Voyager | 86 - 2 | | 2285 | A3+ | 2285 | FX3 | | |
| ZRX | 1200 / S / R | 01 - 08 | 2 | 2255 | XBK5 A3+ | 2282 | FX3 | | |
| ZX12-R | 1200 Ninja | 00 - 03 | 2 | 2255 | XBK5 A3+ | 2282 | FX3 | | |
| ZX12-R | 1200 Ninja (Rad.Cal) | 04 - 2 | | 1110 | XBK5 A3+ | 2282 | FX3 | | |
| ZZR | 1200 | 02 - 2 | | 2251 | XBK5 A3+ | 2282 | FX3 | | |
| Z | 1300 6 | 85 - 2 | | 2285 | A3+ | 2285 | FX3 | | |
| ZN | 1300 A1 / A2 / A2L | 83 - 84 | 2 | 2285 | A3+ | 2285 | FX3 | | |
| ZN | 1300 Voyager | 85 - 2 | | 2285 | A3+ | 2285 | FX3 | | |
| GTR | 1400 (Rad.Cal) | 07 - 2 | | 1177 | XBK5 A3+ | 2813 | FX3 | | |
| ZZR | 1400 (Rad.Cal) | 06 - 2 | | 1177 | XBK5 A3+ | 2813 | FX3 | | |
| VN | 1500 A1-A10 Vulcan SE | 87 - 96 | 1 | 2285 | A3+ | 2285 | FX3 | | |
| VN | 1500 B1-B4 / C1 / C2 Vulcan | 87 - 95 | 1 | 2285 | A3+ | 2285 | FX3 | | |
| VN | 1500 Classic | 96 - 1 | | 2383 | A3+ | 2285 | FX3 | | |
| VN | 1500 Classic Fi | 00 - 1 | | 2383 | A3+ | 2384 | FX3 | | |
| VN | 1500 Classic Tourer | 98 - 1 L | | 2383 | A3+ | 2285 | FX3 | | |
| VN | 1500 Classic Tourer | 98 - 1 R | | 2384 | A3+ | | | | |
| VN | 1500 Classic Tourer Fi | 00 - 1 L | | 2383 | A3+ | 2384 | FX3 | | |
| VN | 1500 Classic Tourer Fi | 00 - 1 R | | 2384 | A3+ | | | | |
| VN | 1500 Drifter | 99 - 02 | 1 | 2383 | A3+ | 2384 | FX3 | | |
| VN | 1500 Mean Streak | 02 - 03 | 2 | 2255 | XBK5 A3+ | 2384 | FX3 | | |
| VN | 1500 Sumo | 88 - 1 | | 2285 | A3+ | 2285 | FX3 | | |
| VN | 1500 Vulcan Nomad | 98 - 1 L | | 2383 | A3+ | 2285 | FX3 | | |
| VN | 1500 Vulcan Nomad | 98 - 1 R | | 2384 | A3+ | | | | |
| VN | 1500 Vulcan Nomad Fi | 00 - 1 L | | 2383 | A3+ | 2384 | FX3 | | |
| VN | 1500 Vulcan Nomad Fi | 00 - 1 R | | 2384 | A3+ | | | | |
| VN | 1600 Classic | 03 - 1 L | | 2383 | A3+ | 2384 | FX3 | | |
| VN | 1600 Classic | 03 - 1 R | | 2384 | A3+ | | | | |
| VN | 1600 Mean Streak | 04 - 2 | | 2255 | XBK5 A3+ | 2384 | FX3 | | |
| VN | 1600 Mean Streak | 05 - 2 | | 1110 | XBK5 A3+ | 2384 | FX3 | | |
| VN | 1700 Classic | 09 - 1 L | | 2383 | A3+ | 2384 | FX3 | | |
| VN | 1700 Classic | 09 - 1 R | | 2384 | A3+ | | | | |
| VN | 1700 Classic Tourer | 09 - 1 L | | 2383 | A3+ | 2384 | FX3 | | |
| VN | 1700 Classic Tourer | 09 - 1 R | | 2384 | A3+ | | | | |
| VN | 1700 Voyager | 09 - 2 | | 2251 | XBK5 A3+ | 2384 | FX3 | | |
| VN | 2000 / Vulcan | 04 - 2 | | 2251 | XBK5 A3+ | 2384 | FX3 | | |

KEEWAY

| | | | | | | | | | |
|----|-----------------|------|---|------|-----|------|------|-----|--|
| | 125 Enduro | 07 - | 1 | 1146 | S4 | 2249 | FX3 | | |
| | 125 Speed | 06 - | 1 | 2306 | A3+ | S4 | 2306 | FX3 | |
| | 125 Superlight | 06 - | 1 | 2288 | A3+ | S4 | T | | |
| | 125 X-Ray | 07 - | 1 | 1146 | S4 | 2249 | FX3 | | |
| TX | 125 SM | 10 - | 1 | NA | | 1089 | FX3 | | |
| | 150 Speed | 06 - | 1 | 2306 | A3+ | S4 | 2306 | FX3 | |
| | 150 Superlight | 06 - | 1 | 2288 | A3+ | S4 | T | | |
| | 250 Landcruiser | 06 - | 1 | 2288 | A3+ | S4 | T | | |
| | 250 Supershadow | 06 - | 1 | 2546 | A3+ | S4 | T | | |

KRAM-IT

| | | | | | | | | | |
|-----|-----|------|---|------|----------|------|-----|--|--|
| SM | 250 | 00 - | 1 | 2352 | XBK5 A3+ | 2353 | FX3 | | |
| SMR | 250 | 00 - | 1 | NA | | 2353 | FX3 | | |

KREIDLER

| | | | | | | | | | |
|-----|-------------------|------|---|------|-----|----|----|--|--|
| | 125 Enduro | 07 - | 1 | 2288 | A3+ | S4 | NA | | |
| | 125 Florett D | 07 - | 1 | 2326 | A3+ | S4 | NA | | |
| | 125 Florett RMC-F | 07 - | 1 | 2326 | A3+ | S4 | NA | | |
| | 125 Supermoto | 07 - | 1 | 2288 | A3+ | S4 | NA | | |
| | 200 Enduro | 07 - | 1 | 2288 | A3+ | S4 | NA | | |
| RSV | 50 | 86 - | 1 | 2249 | A3+ | S4 | T | | |

KTM

| | | | | BEST CHOICE | | OTHER CHOICE | | BEST CHOICE | |
|-------|------------------------------|---------|---|-------------|----------|--------------|------|-------------|--|
| | 80 PL/RS/L / RS/ RL/ Chopper | 80 - | 1 | 2249 | A3+ | S4 | 2249 | FX3 | |
| LC2 | 125 | 99 - | 1 | 2352 | A3+ | | 2353 | FX3 | |
| | 125 Euro Trail | 96 - | 1 | 2352 | A3+ | | 2353 | FX3 | |
| SX | 125 SM | 00 - | 1 | 2352 | XBK5 A3+ | | 2353 | FX3 | |
| | 125 Sting | 97 - | 1 | 2247 | A3+ | S4 | 2353 | FX3 | |
| SX | 450 SM / SM Factory Replica | 04 - | 1 | 2247 | XBK5 A3+ | | 1108 | FX3 | |
| SX | 450 SMR | 04 - 06 | 1 | BERINGER | | | 1108 | FX3 | |
| SX | 450 SMR | 07 - 10 | 1 | 1129 | XBK5 A3+ | | 1108 | FX3 | |
| SX | 525 SMR | 04 - 05 | 1 | BERINGER | | | 1108 | FX3 | |
| SX | 560 SMR | 06 | 1 | 1129 | XBK5 A3+ | | 1108 | FX3 | |
| | 620 Duke | 94 - 98 | 1 | 2247 | XBK5 A3+ | | 2249 | FX3 | |
| LC4 | 620 SC Supermoto | 00 | 1 | 2352 | XBK5 A3+ | | 2353 | FX3 | |
| LC4 | 625 SC Supermoto | 02 - 04 | 1 | 2352 | XBK5 A3+ | | 2353 | FX3 | |
| | 625 SMC | 05 - 06 | 1 | 2539 | XBK5 A3+ | | 2353 | FX3 | |
| LC4 | 640 Adventure R | 00 | 1 | 2352 | XBK5 A3+ | | 2353 | FX3 | |
| LC4 | 640 Adventure | 01 - 02 | 1 | 2352 | XBK5 A3+ | | 2353 | FX3 | |
| LC4 | 640 Adventure (2 sets) | 03 - 07 | 2 | 2352 | XBK5 A3+ | | 2353 | FX3 | |
| LC4-E | 640 Supermoto | 99 - 06 | 1 | 2352 | XBK5 A3+ | | 2353 | FX3 | |
| SMC | 640 LC4 | 05 | 1 | 2539 | XBK5 A3+ | | 2353 | FX3 | |
| | 640 Duke II | 99 - 07 | 1 | 2539 | XBK5 A3+ | | 2353 | FX3 | |
| LC4 | 660 SM Factory Replica | 02 - | 1 | 2247 | XBK5 A3+ | | 2353 | FX3 | |
| | 660 SMC | 03 - 04 | 1 | 2247 | XBK5 A3+ | | 2353 | FX3 | |
| | 660 SMC | 05 - 06 | 1 | 2539 | XBK5 A3+ | | 2353 | FX3 | |
| | 690 SM | 07 - 09 | 1 | 2539 | XBK5 A3+ | | 2353 | FX3 | |
| | 690 SMC | 08 - 10 | 1 | 1033 | XBK5 A3+ | | 2353 | FX3 | |
| | 690 SMR | 07 - 09 | 1 | 1033 | XBK5 A3+ | | 2353 | FX3 | |
| | 690 Duke | 08 - | 1 | 1033 | XBK5 A3+ | | 2353 | FX3 | |
| | 690 Duke R | 10 - | 1 | 1033 | XBK5 A3+ | | 2353 | FX3 | |
| LC-8 | 950 Adventure | 02 - | 2 | 2396 | A3+ | | 2353 | FX3 | |
| | 950 Duke | 03 - | 2 | 1033 | XBK5 A3+ | | 2353 | FX3 | |
| | 950 SM | 05 - | 2 | 1033 | XBK5 A3+ | | 2352 | FX3 | |
| | 950 SMR | 07 | 2 | 1033 | XBK5 A3+ | | 2352 | FX3 | |
| | 950 Superenduro | 06 - | 1 | 2396 | XBK5 A3+ | | 2352 | FX3 | |
| | 990 Adventure / S | 06 - 08 | 2 | 2396 | A3+ | | 2352 | FX3 | |
| | 990 Supermoto / R | 07 - | 2 | 1033 | XBK5 A3+ | | 2352 | FX3 | |
| | 990 Super moto T | 09 - | 2 | 1033 | XBK5 A3+ | | 2352 | FX3 | |
| | 990 Super Duke | 05 - | 2 | 1033 | XBK5 A3+ | | 2353 | FX3 | |
| | 990 Super Duke R | 09 - | 2 | 1033 | XBK5 A3+ | | 2353 | FX3 | |
| RC-8 | 1190 | 08 - | 2 | 1185 | XBK5 A3+ | | 2827 | FX3 | |
| RC8 | 1190 R | 09 - | 2 | 1185 | XBK5 A3+ | | 2827 | FX3 | |

KYMCO

| | | | | | | | | | |
|----|-------------|---------|---|------|-----|----|------|-----|--|
| | 125 Cruiser | 99 - | 1 | 2326 | A3+ | S4 | T | | |
| | 125 Hipster | 99 - 06 | 1 | 2326 | A3+ | S4 | T | | |
| | 125 Pulsar | 99 - 06 | 1 | 2326 | A3+ | S4 | T | | |
| | 125 Quannon | 08 - | 1 | 2326 | A3+ | S4 | 2326 | FX3 | |
| | 125 Stryker | 01 - 06 | 1 | 2288 | A3+ | S4 | T | | |
| | 125 Zing | 97 - 03 | 1 | 2326 | A3+ | S4 | T | | |
| | 125 Zing II | 04 - 09 | 1 | 2326 | A3+ | S4 | T | | |
| CK | 125 | 04 - | 1 | 2621 | A3+ | S4 | T | | |
| DX | 150 Custom | 93 - | 1 | 2621 | A3+ | S4 | T | | |
| | 150 Hipster | 99 - 06 | 1 | 2326 | A3+ | S4 | T | | |
| | 150 NSR | 93 - | 1 | 2621 | A3+ | S4 | T | | |
| | 150 Stryker | 05 - | 1 | 2288 | A3+ | S4 | T | | |
| | 150 Zing | 97 - 09 | 1 | 2326 | A3+ | S4 | T | | |
| | 250 Venox | 00 - 10 | 1 | 2256 | A3+ | S4 | T | | |

LAVERDA

| | | | | | | | | | |
|-----|------------------|------|---|------|----------|----|------|-----|--|
| | 50 Gaucho | 92 | 1 | 2249 | A3+ | S4 | 2249 | FX3 | |
| OR | 50 Atlas | 86 | 1 | 2249 | A3+ | S4 | 2249 | FX3 | |
| OR | 50 Atlas | 90 - | 1 | 2249 | A3+ | S4 | 2249 | FX3 | |
| CU | 125 Ride | 86 - | 1 | 2249 | A3+ | S4 | T | | |
| LB | 125 Uno | 85 - | 1 | 2249 | A3+ | S4 | T | | |
| | 125 Custom | 86 - | 1 | 2249 | A3+ | S4 | T | | |
| GS | 350 Lesmo | 86 - | 2 | 2249 | A3+ | S4 | 2249 | FX3 | |
| PF | 350 Alpino | | 2 | 2249 | A3+ | S4 | 2249 | FX3 | |
| RS | 350 Alpino | | 2 | 2249 | A3+ | S4 | 2249 | FX3 | |
| SFC | 500 | | 2 | 2332 | A3+ | | 2332 | FX3 | |
| | 500 Alpino / S | 77 - | 2 | 2249 | A3+ | S4 | 2249 | FX3 | |
| OR | 600 Atlas | 86 - | 1 | 2801 | A3+ | | 2249 | FX3 | |
| SFC | 600 | 86 - | 2 | 2332 | A3+ | | 2332 | FX3 | |
| | 650 Ghost | 96 - | 2 | 2247 | XBK5 A3+ | | 2249 | FX3 | |
| | 650 Ghost Legend | 97 - | 2 | 2247 | XBK5 A3+ | | 2249 | FX3 | |
| | 650 Sport | 92 - | 2 | 2247 | XBK5 A3+ | | 2249 | FX3 | |
| | 650 Strike | 97 - | 2 | 2247 | XBK5 A3+ | | 2249 | FX3 | |
| | 650 V Six | 93 - | 2 | 2332 | A3+ | | 2332 | FX3 | |
| | 668 Diamante | 97 - | 2 | 2247 | XBK5 A3+ | | 2249 | FX3 | |
| | 668 Ghost Strike | 98 - | 2 | 2247 | XBK5 A3+ | | 2249 | FX3 | |
| | 668 | 96 - | 2 | 2247 | XBK5 A3+ | | 2249 | FX3 | |



LAVERDA

| | 700 | El Cid | 90 - | 2 | 2306 | A3+ | | 2306 | RX3 |
|-----|------|------------------------|---------|---|------|------|-----|------|-----|
| | 750 | Cup | 98 - | 2 | 2247 | XBK5 | A3+ | 2249 | RX3 |
| | 750 | Diamante | 97 - | 2 | 2247 | XBK5 | A3+ | 2249 | RX3 |
| | 750 | Ghost Strike | 97 - | 2 | 2247 | XBK5 | A3+ | 2249 | RX3 |
| | 750 | S / S Formula / Strike | 97 - | 2 | 2247 | XBK5 | A3+ | 2249 | RX3 |
| | 750 | S SPORT | 99 - | 2 | 2247 | XBK5 | A3+ | 2249 | RX3 |
| SF2 | 750 | | 74 - 78 | 2 | 2332 | A3+ | | T | |
| SF3 | 750 | RGS Corsa / Executive | 77 - | 2 | 2332 | A3+ | | 2332 | RX3 |
| TTS | 800 | | 99 - | 2 | 2247 | XBK5 | A3+ | 2827 | RX3 |
| 3C | 1000 | 3CE / 3CL | 74 - | 2 | 2332 | A3+ | | 2332 | RX3 |
| RGS | 1000 | Jota | 86 - | 2 | 2332 | A3+ | | 2332 | RX3 |
| RGS | 1000 | | 83 - | 2 | 2332 | A3+ | | 2332 | RX3 |
| SFC | 1000 | | 85 - 86 | 2 | 2332 | A3+ | | 2332 | RX3 |
| SFC | 1000 | (Rad.cal.) | 04 - | 2 | 1033 | XBK5 | A3+ | 2827 | RX3 |
| TGA | 1000 | Executive | 84 - | 2 | 2332 | A3+ | | 2332 | RX3 |
| | 1000 | Jota | 76 - | 2 | 2332 | A3+ | | 2332 | RX3 |
| | 1200 | Mirage | 78 - | 2 | 2332 | A3+ | | 2332 | RX3 |

MAICO

| | | | | | | | | | |
|--|-----|-------------|------|---|------|------|-----|------|-----|
| | 500 | Supermotard | 99 - | 1 | 2352 | XBK5 | A3+ | 2353 | RX3 |
|--|-----|-------------|------|---|------|------|-----|------|-----|

MEGELLI

| | | | | | | | | | |
|--|-----|-----------|------|---|------|-----|--|----|--|
| | 125 | M / R / S | 08 - | 1 | 2621 | A3+ | | NA | |
|--|-----|-----------|------|---|------|-----|--|----|--|

MONDIAL

| | | | | | | | | | |
|--|------|-------------------------|------|---|------|------|-----|------|-----|
| | 1000 | Evo (Rad. Cal.) | 04 - | 2 | 1033 | XBK5 | A3+ | 2827 | RX3 |
| | 1000 | Piega | 03 - | 2 | 1033 | XBK5 | A3+ | 2827 | RX3 |
| | 1000 | RZ Nuda | 04 - | 2 | 1033 | XBK5 | A3+ | 2827 | RX3 |
| | 1000 | Starfighter (Rad. Cal.) | 04 - | 2 | 1033 | XBK5 | A3+ | 2827 | RX3 |

MORBIDELLI

| | | | | | | | | | |
|--|-----|----|--|---|------|-----|----|------|-----|
| | 125 | cc | | 2 | 2377 | A3+ | S4 | 2377 | RX3 |
|--|-----|----|--|---|------|-----|----|------|-----|

MOTO GUZZI

| | | | | | | | | | |
|-----|-----|------------------------|---------|---|------|-----|----|------|-----|
| | 125 | BX | 92 | 1 | 2249 | A3+ | S4 | 2249 | RX3 |
| | 125 | Custom | 85 | 1 | 2249 | A3+ | S4 | T | |
| | 125 | Enduro TT | 85 | 1 | 2249 | A3+ | S4 | T | |
| | 240 | / 4 | 77 - | 1 | 2249 | A3+ | S4 | T | |
| | 250 | TS | 75 - 76 | 1 | 2249 | A3+ | S4 | T | |
| | 350 | | 77 - | 2 | 2249 | A3+ | | 2249 | RX3 |
| | 350 | Falco | 88 | 1 | 2249 | A3+ | | 2249 | RX3 |
| | 350 | Imola | 78 - | 2 | 2249 | A3+ | | 2249 | RX3 |
| | 350 | Nevada | 92 - | 2 | 2249 | A3+ | | 2249 | RX3 |
| NTX | 350 | | 88 | 1 | 2249 | A3+ | | 2249 | RX3 |
| NTX | 350 | | 90 - | 1 | 2249 | A3+ | | 2332 | RX3 |
| V35 | 350 | C | | 2 | 2332 | A3+ | S4 | 2249 | RX3 |
| V35 | 350 | Florida | | 2 | 2332 | A3+ | S4 | 2249 | RX3 |
| V35 | 350 | GT | | 1 | 2249 | A3+ | | T | |
| V35 | 350 | GT | 90 - | 1 | 2332 | A3+ | S4 | 2249 | RX3 |
| V35 | 350 | II / Imola / Imola II | 77 | 2 | 2249 | A3+ | | 2249 | RX3 |
| V35 | 350 | III | 87 - | 2 | 2332 | A3+ | S4 | 2332 | RX3 |
| V35 | 350 | TT | 86 - | 2 | 2332 | A3+ | S4 | 2332 | RX3 |
| | 400 | | 79 - | 2 | 2249 | A3+ | | 2249 | RX3 |
| | 500 | | 77 - | 2 | 2249 | A3+ | | 2249 | RX3 |
| V50 | 500 | 1/2/3/ Monza / Chopper | 77 | 2 | 2249 | A3+ | | 2249 | RX3 |
| | 500 | Monza | 78 - | 2 | 2249 | A3+ | | 2249 | RX3 |
| | 650 | | 80 - | 2 | 2249 | A3+ | | 2249 | RX3 |
| GT | 650 | Sessantacinque | 89 | 2 | 2249 | A3+ | | 2249 | RX3 |
| NTX | 650 | | 90 - | 1 | 2249 | A3+ | | 2332 | RX3 |
| V65 | 650 | Florida | 86 - | 2 | 2332 | A3+ | | 2332 | RX3 |
| V65 | 650 | GT | 90 - | 1 | 2332 | A3+ | | NA | |
| V65 | 650 | Lario | 86 - | 2 | 2249 | A3+ | | 2249 | RX3 |
| V65 | 650 | NTX | 87 - | 1 | 2249 | A3+ | | 2249 | RX3 |
| V65 | 650 | SP / Chopper | | 2 | 2249 | A3+ | | 2249 | RX3 |
| V65 | 650 | TT | 86 - | 2 | 2249 | A3+ | | 2249 | RX3 |
| V7 | 744 | Classic | 08 - | 1 | 2539 | A3+ | | 2827 | RX3 |
| V7 | 744 | Café Classic | 09 - | 1 | 2539 | A3+ | | 2827 | RX3 |
| | 750 | Breva i.e | 03 - | 2 | 2539 | A3+ | | 2827 | RX3 |
| | 750 | Nevada | 91 - 92 | 2 | 2249 | A3+ | | 2249 | RX3 |
| | 750 | Nevada Club | 98 - 01 | 2 | 2249 | A3+ | | 2827 | RX3 |
| | 750 | Nevada / Nevada Club | 03 - 04 | 1 | 2539 | A3+ | | 2827 | RX3 |
| | 750 | Nevada Classic i.e | 05 - | 1 | 2539 | A3+ | | 2827 | RX3 |
| | 750 | Nevada Touring | 07 - | 1 | 2539 | A3+ | | 2827 | RX3 |
| | 750 | Targa | 89 | 2 | 2249 | A3+ | | 2249 | RX3 |
| NTX | 750 | | 89 | 1 | 2249 | A3+ | | 2249 | RX3 |
| NTX | 750 | | 90 - | 1 | 2393 | A3+ | | 2332 | RX3 |
| S3 | 750 | | 75 - 76 | 2 | 2332 | A3+ | | T | |
| SP | 750 | | 91 - | 1 | 2332 | A3+ | | 2332 | RX3 |

MOTO GUZZI

| | | | | | | | | | |
|-----|------|--------------------------------------------|---------|---|------|------|-----|------|-----|
| V7 | 750 | Ippogrifo | 97 - | 2 | 2247 | XBK5 | A3+ | 2249 | RX3 |
| V7 | 750 | Clubman Racer | 10 - | 2 | 2539 | A3+ | | 2827 | RX3 |
| V75 | 750 | | 86 - | 2 | 2332 | A3+ | | 2332 | RX3 |
| V75 | 750 | Duna | 86 - | 1 | 2332 | A3+ | | 2332 | RX3 |
| V75 | 750 | Paris Dakar TT | 86 - | 1 | 2332 | A3+ | | 2332 | RX3 |
| | 850 | Le Mans | 76 - | 2 | 2332 | A3+ | | 2332 | RX3 |
| | 850 | Breva | 07 - | 2 | 2539 | XBK5 | A3+ | 2352 | RX3 |
| | 850 | Griso | 07 - | 2 | 2539 | XBK5 | A3+ | 2352 | RX3 |
| | 850 | Norge | 07 - | 2 | 2539 | XBK5 | A3+ | 2352 | RX3 |
| T | 850 | | 74 - 76 | 1 | 2332 | A3+ | | T | |
| T3 | 850 | | 75 - | 2 | 2332 | A3+ | | 2332 | RX3 |
| T4 | 850 | | 75 - | 2 | 2332 | A3+ | | 2332 | RX3 |
| T5 | 850 | N.T. | 86 - | 1 | 2332 | A3+ | | 2332 | RX3 |
| T5 | 850 | | 75 - | 2 | 2332 | A3+ | | 2332 | RX3 |
| | 940 | Bellagio / Custom | 07 - | 2 | 2539 | XBK5 | A3+ | 2396 | RX3 |
| | 1000 | California II | 85 - 88 | 2 | 2332 | A3+ | | 2332 | RX3 |
| | 1000 | California III Fuel Inj. | 89 | 2 | 2332 | A3+ | | 2332 | RX3 |
| | 1000 | California III C | 91 - 95 | 2 | 2332 | A3+ | | 2332 | RX3 |
| | 1000 | Daytona | 91 - | 2 | 2247 | XBK5 | A3+ | 2332 | RX3 |
| | 1000 | Le Mans IV | 85 - | 2 | 2332 | A3+ | | 2332 | RX3 |
| | 1000 | Le Mans V | 90 - 95 | 2 | 2332 | A3+ | | 2332 | RX3 |
| | 1000 | Quota | 92 - 97 | 2 | 2398 | A3+ | | 2249 | RX3 |
| GT | 1000 | V | 91 - | 2 | 2332 | A3+ | | 2332 | RX3 |
| RS | 1000 | Daytona | 97 - | 2 | 2247 | XBK5 | A3+ | 2249 | RX3 |
| S | 1000 | | 90 | 2 | 2332 | A3+ | | 2332 | RX3 |
| SP | 1000 | III | 91 - | 2 | 2332 | A3+ | | 2332 | RX3 |
| SP | 1000 | Le Mans | 79 - | 1 | 2332 | A3+ | | 2332 | RX3 |
| V | 1000 | Strada | 93 - 94 | 2 | 2332 | A3+ | | 2332 | RX3 |
| V10 | | Centaurio | 97 - 99 | 2 | 2247 | XBK5 | A3+ | 2249 | RX3 |
| | 1100 | Breva V1100 | 05 | 2 | 2539 | XBK5 | A3+ | 2352 | RX3 |
| | 1100 | Breva | 05 - 06 | 2 | 2539 | XBK5 | A3+ | 2352 | RX3 |
| | 1100 | Breva (ABS) | 07 | 2 | 2539 | XBK5 | A3+ | 2352 | RX3 |
| | 1100 | California | 94 - 97 | 2 | 2332 | A3+ | | 2332 | RX3 |
| | 1100 | California (2 pin pad fixing) | 01 - 05 | 2 | 2539 | A3+ | | 2396 | RX3 |
| | 1100 | California Vintage | 06 - 10 | 2 | 2539 | A3+ | | 2396 | RX3 |
| | 1100 | California EV (2 pin pad fixing) | 01 - | 2 | 2539 | A3+ | | 2396 | RX3 |
| | 1100 | California Jackal (Single pin pad fixing) | 99 - 01 | 2 | 2247 | XBK5 | A3+ | 2396 | RX3 |
| | 1100 | California Special (Single pin pad fixing) | 99 - 00 | 2 | 2247 | XBK5 | A3+ | 2396 | RX3 |
| | 1100 | California Sport (2 pin pad fixing) | 01 - 02 | 2 | 2539 | A3+ | | 2396 | RX3 |
| | 1100 | Metal | 02 - 03 | 2 | 2539 | A3+ | | 2396 | RX3 |
| | 1100 | Aluminium | 03 - 05 | 2 | 2539 | A3+ | | 2396 | RX3 |
| | 1100 | Titanium Handlebar Fairing | 03 - 05 | 2 | 2539 | A3+ | | 2396 | RX3 |
| | 1100 | Classic | 06 - 09 | 2 | 2539 | A3+ | | 2396 | RX3 |
| | 1100 | Touring | 06 - 07 | 2 | 2539 | A3+ | | 2396 | RX3 |
| | 1100 | California EV (Single pin pad fixing) | 97 - 00 | 2 | 2247 | XBK5 | A3+ | 2249 | RX3 |
| | 1100 | Griso | 05 - | 2 | 2539 | XBK5 | A3+ | 2352 | RX3 |
| | 1100 | Griso 8v | 07 - 08 | 2 | 2539 | XBK5 | A3+ | 2352 | RX3 |
| | 1100 | Sport | 94 - 99 | 2 | 2247 | XBK5 | A3+ | 2249 | RX3 |
| | 1100 | Sport Corsa | 98 - 99 | 2 | 2247 | XBK5 | A3+ | 2249 | RX3 |
| ES | 1100 | Quota | 99 - 01 | 2 | 2396 | XBK5 | A3+ | 2352 | RX3 |
| V11 | 1100 | Lemans (All Models) | 01 - 04 | 2 | 2539 | XBK5 | A3+ | 2249 | RX3 |
| V11 | 1100 | Scura / Sport Scura | 02 - | 2 | 2539 | XBK5 | A3+ | 2249 | RX3 |
| V11 | 1100 | Sport | 97 - 00 | 2 | 2247 | XBK5 | A3+ | 2249 | RX3 |
| V11 | 1100 | Sport (All Models) | 01 - | 2 | 2539 | XBK5 | A3+ | 2249 | RX3 |
| | 1200 | Breva | 08 - | 2 | 2539 | XBK5 | A3+ | 2352 | RX3 |
| | 1200 | Corsa MGS-01 | 07 - | 2 | 1033 | XBK5 | A3+ | 2827 | RX3 |
| | 1200 | Griso 8V | 07 - | 2 | 2539 | XBK5 | A3+ | 2352 | RX3 |
| | 1200 | Norge | 06 - | 2 | 2539 | XBK5 | A3+ | 2352 | RX3 |
| | 1200 | Norge GT 8V | 10 - | 2 | 2539 | XBK5 | A3+ | 2352 | RX3 |
| | 1200 | Sport ABS | 06 - 07 | 2 | 2539 | XBK5 | A3+ | 2352 | RX3 |
| | 1200 | Sport 2V | 06 - 09 | 2 | 2539 | XBK5 | A3+ | 2352 | RX3 |
| | 1200 | Sport 4V | 08 - 09 | 2 | 2539 | XBK5 | A3+ | 2352 | RX3 |
| | 1200 | Stelvio (ABS) | 08 - | 2 | 2539 | XBK5 | A3+ | 235 | |



MOTO MORINI

| | | | | BEST CHOICE | OTHER CHOICE | BEST CHOICE |
|---------------------|---------|---|------|-------------|--------------|-------------|
| 750 Indiana | 88 | 1 | 2801 | A3+ | 2499 | RX3 |
| 998 9 1/2 | 06 - 10 | 2 | 2539 | XBK5 A3+ | 2827 | RX3 |
| 1187 MM3 | 07 | 2 | 2539 | XBK5 A3+ | 2827 | RX3 |
| 1200 Corsaro | 05 - 10 | 2 | 2539 | XBK5 A3+ | 2827 | RX3 |
| 1200 Corsaro Avio | 08 - 09 | 2 | 2539 | XBK5 A3+ | 2827 | RX3 |
| 1200 Corsaro Veloce | 07 - 09 | 2 | 2539 | XBK5 A3+ | 2827 | RX3 |
| 1200 Granferro | 10 | 2 | 1033 | XBK5 A3+ | 2352 | RX3 |
| 1200 Granpasso | 08 - 10 | 2 | 2396 | XBK5 A3+ | 2352 | RX3 |
| 1200 GT | 10 | 2 | 2396 | XBK5 A3+ | 2352 | RX3 |
| 1200 Scrambler | 08 - 10 | 2 | 2539 | XBK5 A3+ | 2827 | RX3 |
| 1200 Sport | 08 - 10 | 2 | 2539 | XBK5 A3+ | 2827 | RX3 |

MH (MOTORHISPANIA)

| | | | | | | | |
|----------------------|------|---|------|-----|----|------|-----|
| RYZ 125 Arena Enduro | 05 - | 1 | 2377 | A3+ | S4 | 2377 | RX3 |
|----------------------|------|---|------|-----|----|------|-----|

MV AGUSTA

| | | | | | | |
|-----------------------------------|---------|---|------|----------|------|-----|
| 750 Brutale (All Models) (Nissin) | 03 - 08 | 2 | 2899 | XBK5 A3+ | 1203 | RX3 |
| 750 F4 (All Models) (Nissin) | 99 - 03 | 2 | 2899 | XBK5 A3+ | 1203 | RX3 |
| 910 Brutale S (Nissin) | 05 - 08 | 2 | 2899 | XBK5 A3+ | 1203 | RX3 |
| 910 Brutale R (Brembo) | 05 - 08 | 2 | 1033 | XBK5 A3+ | 1203 | RX3 |
| 989 Brutale R | 08 - 09 | 2 | 2539 | XBK5 A3+ | 1203 | RX3 |
| 920 Brutale | 11 - | 2 | 2539 | XBK5 A3+ | 1203 | RX3 |
| 990 Brutale R | 10 - | 2 | 2539 | XBK5 A3+ | 1203 | RX3 |
| 998 F4 | 10 - | 2 | 1185 | XBK5 A3+ | 1203 | RX3 |
| 1000 F4 (All Models) (Nissin) | 04 - 06 | 2 | 2899 | XBK5 A3+ | 1203 | RX3 |
| 1000 F4 Senna | 06 | 2 | 1033 | XBK5 A3+ | 1203 | RX3 |
| 1000 F4 R (Brembo) | 06 - 07 | 2 | 1033 | XBK5 A3+ | 1203 | RX3 |
| 1000 F4 RR 312 (Brembo) | 07 | 2 | 1033 | XBK5 A3+ | 1203 | RX3 |
| 1078 Brutale RR | 08 - 09 | 2 | 1185 | XBK5 A3+ | 1203 | RX3 |
| 1078 F4 RR 312 (Brembo) | 08 - | 2 | 1185 | XBK5 A3+ | 1203 | RX3 |
| 1090 Brutale RR | 10 - | 2 | 1185 | XBK5 A3+ | 1203 | RX3 |

MZ / MUZ

| | | | | | | |
|-------------------------------|---------|---|------|----------|------|----------|
| 125 ETZ | 82 - 92 | 1 | 2332 | A3+ | S4 | T |
| 125 SM/SX (All models) | 99 - 01 | 1 | NA | | | 2326 RX3 |
| 125 SM/SX (All models) | 02 - 07 | 1 | 2288 | A3+ | S4 | 2326 RX3 |
| 125 Roadstar | | 1 | 2332 | A3+ | S4 | T |
| 125 RT (All models) | 02 - 07 | 1 | 2326 | A3+ | S4 | 2326 RX3 |
| 125 Saxon | 93 - 97 | 1 | 2332 | A3+ | S4 | T |
| 125 Sportstar | 93 - | 1 | 2332 | A3+ | S4 | T |
| 150 ETZ | 82 - 92 | 1 | 2332 | A3+ | S4 | T |
| 150 Saxon | 95 | 1 | 2332 | A3+ | S4 | T |
| 250 ETZ | 82 - 92 | 1 | 2332 | A3+ | S4 | T |
| 251 ETZ | 89 | 1 | 2332 | A3+ | S4 | T |
| 251 Fun | 95 - 96 | 1 | 2332 | A3+ | S4 | T |
| 251 Saxon Tour | | 1 | 2332 | A3+ | S4 | T |
| 300 ETZ | 82 - 92 | 1 | 2332 | A3+ | S4 | T |
| 301 ETZ | 90 - | 1 | 2332 | A3+ | S4 | T |
| 301 Saxon Tour | | 1 | 2332 | A3+ | S4 | T |
| 301 Sportstar | 96 - | 1 | 2332 | A3+ | S4 | T |
| 500 Saxon (All Models) | 93 - 98 | 1 | 2332 | A3+ | | T |
| 500 Silver Star Classic | 93 - | 1 | 2332 | A3+ | | T |
| 500 Silverstar Voyager | 96 - | 1 | 2332 | A3+ | | T |
| 500 Tour | 96 - | 1 | 2332 | A3+ | | T |
| 660 Baghira (All Models) | 96 - 05 | 1 | NA | | | 2472 RX3 |
| 660 Black Panther | 00 - | 1 | NA | | | 2472 RX3 |
| 660 Mastiff 21" | 96 - 05 | 1 | NA | | | 2472 RX3 |
| 660 Mastiff 17" | 99 - 05 | 1 | 2247 | XBK5 A3+ | 2249 | RX3 |
| 660 Skorpion Sport / Cup | 95 - 01 | 1 | 2247 | XBK5 A3+ | 2249 | RX3 |
| 660 Skorpion Replica | 95 - 01 | 1 | 2247 | XBK5 A3+ | 2249 | RX3 |
| 660 Skorpion Tour / Traveller | 95 - 02 | 1 | 2247 | XBK5 A3+ | 2249 | RX3 |
| 660 Street Moto | 00 - | 1 | NA | | | 2472 RX3 |
| 660 Super Moto | 07 - | 1 | NA | | | 2472 RX3 |
| 1000 S | 01 - 02 | 2 | 2539 | XBK5 A3+ | NA | |
| 1000 S | 03 - 07 | 2 | 2246 | XBK5 A3+ | 2813 | RX3 |
| 1000 SF | 05 - 07 | 2 | 2246 | XBK5 A3+ | 2813 | RX3 |
| 1000 SFX | 07 - | 2 | 2246 | XBK5 A3+ | 2813 | RX3 |
| 1000 SN | 05 - | 2 | 2246 | XBK5 A3+ | 2813 | RX3 |
| 1000 ST | 07 - | 2 | 2246 | XBK5 A3+ | 2813 | RX3 |

NORTON

| | | | | | | |
|------------------------------|---------|---|------|----------|------|-----|
| 588 Classic | 89 | 2 | 2332 | A3+ | 2332 | RX3 |
| 588 Commander (Rotary) | 90 | 2 | 2283 | A3+ | 2283 | RX3 |
| 588 F-1 (Rotary) P55 Model | 90 | 2 | 2247 | XBK5 A3+ | 2249 | RX3 |
| 588 F-1 (Rotary) P55 B Model | 90 - 91 | 2 | 2247 | XBK5 A3+ | 2247 | RX3 |
| 588 Interpol 2 (Rotary) | 89 | 2 | 2332 | A3+ | 2332 | RX3 |
| 588 TT | 92 - | 2 | 2247 | XBK5 A3+ | NA | |
| 961 Commando Café Racer | 10 | 2 | 1033 | XBK5 A3+ | 2827 | RX3 |
| 961 Commando SE | 10 | 2 | 2539 | XBK5 A3+ | 2827 | RX3 |

NORTON

| | | | | | | |
|--------------------|----|---|------|----------|------|-----|
| 961 Commando Sport | 10 | 2 | 2539 | XBK5 A3+ | 2827 | RX3 |
|--------------------|----|---|------|----------|------|-----|

RIEJU

| | | | | | | |
|-----------------------------------|---------|---|------|-----|------|-----|
| 125 Marathon Pro Supermotard | 09 - 10 | 1 | NA | A3+ | 2306 | RX3 |
| 125 Marathon Pro (Radial Caliper) | 09 - 10 | 1 | NA | A3+ | 2306 | RX3 |
| 125 MRX | 02 - 08 | 1 | 1144 | S4 | 2377 | RX3 |
| 125 NKD | 06 - 07 | 1 | NA | | 2377 | RX3 |
| 125 NKD | 08 - 10 | 1 | 1148 | A3+ | 2306 | RX3 |
| 125 RS2 (AJP Caliper) | 06 - 10 | 1 | NA | | 2377 | RX3 |
| 125 RS2 (J.Juan Caliper) | 07 - 10 | 1 | 1148 | A3+ | 2306 | RX3 |
| 125 RS2 Pro (J.Juan Caliper) | 07 - 10 | 1 | 1148 | A3+ | 2306 | RX3 |
| 125 SMX | 02 - 07 | 1 | 1144 | S4 | 2377 | RX3 |
| 125 SMX (Cast Wheel) | 07 - 08 | 1 | NA | A3+ | 2377 | RX3 |
| 125 Tango | 06 - 10 | 1 | NA | A3+ | 2377 | RX3 |
| 125 Tango Motard (Cast Wheel) | 08 - 09 | 1 | NA | A3+ | 2306 | RX3 |
| 125 Tango pro | 07 - 10 | 1 | NA | A3+ | 2377 | RX3 |
| 250 Tango (All models) | 08 - 10 | 1 | NA | A3+ | 2377 | RX3 |

SACHS

| | | | | | | |
|--------------------|---------|---|------|----------|------|----------|
| 125 Roadster | 00 - 03 | 1 | 1144 | S4 | T | |
| 125 X-Road | 06 | 1 | 2247 | A3+ | S4 | 2472 RX3 |
| 125 X-Road | 07 | 1 | 2247 | A3+ | S4 | 2408 S4 |
| 125 X-Road | 08 | 1 | 2539 | A3+ | S4 | 2408 S4 |
| XTC 125 Supersport | 00 - 07 | 1 | 2247 | A3+ | S4 | 2472 RX3 |
| XTC 125 | 08 - | 1 | 2539 | A3+ | S4 | 2408 S4 |
| ZX 125 | 98 - | 1 | 2794 | A3+ | S4 | 2472 RX3 |
| ZZ 125 Funbike | 98 - | 1 | 2794 | A3+ | S4 | 2472 RX3 |
| 650 Roadster V1.6 | 01 - 04 | 1 | 2247 | XBK5 A3+ | 2472 | RX3 |
| 650 Roadster V1.6 | 05 - | 1 | 2247 | XBK5 A3+ | 2284 | RX3 |
| 800 Roadster V2 | 00 - | 2 | 2247 | XBK5 A3+ | 2472 | RX3 |
| 805 B / S | 03 - 04 | 2 | 2247 | XBK5 A3+ | 2472 | RX3 |

SANGLAS

| | | | | | | |
|--------|---------|---|------|-----|------|-----|
| 400 Y | 79 - 80 | 2 | 2249 | A3+ | 2249 | RX3 |
| 500 S2 | 79 - 80 | 2 | 2249 | A3+ | 2249 | RX3 |

SHERCO

| | | | | | | |
|-----------------------------------|---------|---|------|----------|------|-----|
| 125 City Corp (All models) | 03 - 07 | 1 | 1144 | S4 | 2377 | RX3 |
| 125 City Corp (All models) | 08 - | 1 | 1146 | S4 | NA | |
| 125 SM 1.25i F Black Panther (4T) | 10 - | 1 | 1146 | S4 | NA | |
| 250 SM 2.5i Supermotard (4T) | 08 - | 1 | 2352 | XBK5 A3+ | 1103 | RX3 |
| 450 SM 4.5i F (Supermotard) | 04 - 10 | 1 | 2352 | XBK5 A3+ | 1103 | RX3 |
| 450 SM 4.5i F (Black Panther) | 08 - 10 | 1 | 1033 | XBK5 A3+ | 1103 | RX3 |
| 510 SM 5.1i F Supermotard | 07 | 1 | 2352 | XBK5 A3+ | 1103 | RX3 |
| 510 SM 5.1i F Black Panther | 08 - 10 | 1 | 1033 | XBK5 A3+ | 1103 | RX3 |

SIMSON

| | | | | | | |
|------------|------|---|------|-----|------|----------|
| SR 80 2 CE | | 1 | 2249 | A3+ | S4 | T |
| 80 IFA | 89 | 1 | 2249 | A3+ | S4 | T |
| S 83 CX | | 1 | 2249 | A3+ | S4 | T |
| S 83 OR | | 1 | 2249 | A3+ | S4 | T |
| 125 SM | 01 - | 1 | 1144 | S4 | 2377 | RX3 |
| 125 SR | 01 - | 1 | 2794 | A3+ | S4 | 2472 RX3 |

SUZUKI

| | | | | | | |
|------------------------------|---------|---|------|-----|----|----------|
| CP 50 | 85 - | 1 | 2469 | S4 | T | |
| CR 50 DC | 87 - | 1 | 2469 | S4 | T | |
| DR 50 Big | 89 - | 1 | 2377 | A3+ | S4 | T |
| GSX-R 50 | 87 - | 1 | 2306 | A3+ | S4 | T |
| OR 50 E | 80 - | 1 | 2306 | A3+ | S4 | T |
| RB 50 H | 87 | 1 | 2306 | A3+ | S4 | T |
| RG 50 GAG | 87 - | 1 | 2306 | A3+ | S4 | T |
| RG 50 Gamma | 90 - | 1 | 2306 | A3+ | S4 | T |
| RMX 50 | 98 - | 1 | 2377 | A3+ | S4 | 2377 RX3 |
| TV 50 Wolf | 89 - | 1 | 2306 | A3+ | S4 | T |
| ZR 50 SAPX / SKX / SLK | 81 - 87 | 1 | 2306 | A3+ | S4 | T |
| GT 80 L/C | 81 - | 1 | 2306 | A3+ | S4 | T |
| RG 80 Gamma | - 87 | 1 | 2306 | A3+ | S4 | T |
| TRS 118 | 82 - 83 | 1 | 2306 | A3+ | S4 | T |
| DF 125 | 98 - 00 | 1 | 2408 | A3+ | S4 | T |
| DR 125 | 86 - 02 | 1 | 2408 | A3+ | S4 | T |
| DR 125 SM | 08 - 10 | 1 | 2300 | A3+ | S4 | 2314 RX3 |
| EN 125 125-2 / 125-2A | 05 - | 1 | 2288 | A3+ | S4 | T |
| GN 125 EM-T | 91 - 04 | 1 | 2306 | A3+ | S4 | T |
| GS 125 ESZ | 82 | 1 | 2306 | A3+ | S4 | T |
| GS 125 ESD / ESF / ESK / ESM | 83 - 94 | 1 | 2306 | A3+ | S4 | T |
| GS 125 ESR / ESX | 95 - 00 | 1 | 2306 | A3+ | S4 | T |
| GT 125 T / ET | 80 - | 1 | 2306 | A3+ | S4 | T |
| GX 125 R | 88 - | 1 | 2408 | A3+ | S4 | T |

SUZUKI

| | | | | BEST CHOICE | | OTHER CHOICE | | BEST CHOICE | |
|-------|----------------------------------------|-------|-----|-------------|----------|--------------|-----|-------------|--|
| GSX | 750 W/X/Y/K1 Inazuma | 97-03 | 1 L | 2383 | XBK5 A3+ | 2282 | FX3 | | |
| GSX | 750 W/X/Y/K1 Inazuma | 97-03 | 1 R | 2384 | XBK5 A3+ | | | | |
| GSX-F | 750 FK/FL/FM/FN/FP/FR/FS/FT/(GR78A) | 89-97 | 2 | 2281 | A3+ | 2282 | FX3 | | |
| GSX-F | 750 FW/FX/FY/FK1 to FK6 | 98-06 | 1 L | 2383 | XBK5 A3+ | 2282 | FX3 | | |
| GSX-F | 750 FW/FX/FY/FK1 to FK6 | 98-06 | 1 R | 2384 | XBK5 A3+ | | | | |
| GSX-R | 750 F / G / H | 85-87 | 2 | 2280 | A3+ | 2282 | FX3 | | |
| GSX-R | 750 RG | 86 | 2 | 2246 | XBK5 A3+ | 2282 | FX3 | | |
| GSX-R | 750 J / K / L / M / WN / WP | 88-93 | 2 | 2246 | XBK5 A3+ | 2282 | FX3 | | |
| GSX-R | 750 WR / WS | 94-95 | 2 | 2255 | XBK5 A3+ | 2282 | FX3 | | |
| GSX-R | 750 T / V / W / X | 96-99 | 2 | 2255 | XBK5 A3+ | 2282 | FX3 | | |
| GSX-R | 750 Y / K1 / K2 / K3 | 00-03 | 2 | 2251 | XBK5 A3+ | 2282 | FX3 | | |
| GSX-R | 750 K4 / K5 (Rad.cal) | 04-05 | 2 | 1133 | XBK5 A3+ | 2813 | FX3 | | |
| GSX-R | 750 K6 / K7 (Rad.cal) | 06-07 | 2 | 1133 | XBK5 A3+ | 1163 | FX3 | | |
| GSX-R | 750 K8 / K9 / L0 (Rad.cal) | 08-10 | 2 | 1133 | XBK5 A3+ | 1163 | FX3 | | |
| GSX-R | 750 Brembo (Rad.cal) | 11- | 2 | 1185 | XBK5 A3+ | 1174 | FX3 | | |
| VS | 750 GLF/GLFG/GLPP Intruder (VR51A) | 85-91 | 2 | 2280 | A3+ | | T | | |
| C | 800 Intruder (VL 800 K5-K9/L0) (C800) | 05- | 1 | 2384 | A3+ | | T | | |
| C90 | 800 Boulevard (VL 800 K5-K9/L0) (C800) | 05- | 1 | 2384 | A3+ | | T | | |
| DR | 800 SL (SR43A) Big | 90 | 1 | 2308 | A3+ | 2388 | FX3 | | |
| DR | 800 SM (SR43A) Big | 91-95 | 1 | 2304 | A3+ | 2326 | FX3 | | |
| DR | 800 ST Big | 96- | 1 | 2383 | A3+ | 2326 | FX3 | | |
| DR-Z | 800 Paris Dakar | 88-90 | 1 | 2308 | A3+ | 2328 | S4 | | |
| M | 800 Intruder (VZ 800 K5-K9/L0) (M800) | 05- | 1 | 2384 | A3+ | | T | | |
| M | 800 Intruder Z (VZ 800 K9Z) (M800) | 09- | 1 | 2384 | A3+ | | T | | |
| M50 | 800 Boulevard | 05- | 1 | 2384 | A3+ | | T | | |
| S50 | 800 Boulevard | 05- | 1 | 2384 | A3+ | | T | | |
| VL | 800 Intruder Volusia K1/K2/K3/K4 | 01-04 | 1 | 2384 | A3+ | | T | | |
| VS | 800 Intruder GLN-GLX (VS52A) | 91-99 | 1 | 2280 | A3+ | | T | | |
| VX | 800 L / M / N / P / R | 90-96 | 1 | 2304 | A3+ | 2281 | FX3 | | |
| VZ | 800 Marauder | 97-04 | 1 | 2384 | A3+ | | T | | |
| GS | 850 GZ / GE / GG | 82-85 | 2 | 2694 | A3+ | | NA | | |
| RF | 900 RR / RS / RS2 | 94-95 | 2 | 2961 | A3+ | 2390 | FX3 | | |
| RF | 900 RT / RV / RW | 96-99 | 2 | 2961 | A3+ | 2282 | FX3 | | |
| DL | 1000 V-Storm K2-K9 | 02-09 | 1 L | 2383 | A3+ | 2296 | FX3 | | |
| DL | 1000 V-Storm K2-K9 | 02-09 | 1 R | 2384 | A3+ | | | | |
| GS | 1000 GT / GX / GLT / GLX | 80-81 | 2 | 2694 | A3+ | | NA | | |
| GSX-R | 1000 K1 / K2 | 01-02 | 2 | 2255 | XBK5 A3+ | 2813 | FX3 | | |
| GSX-R | 1000 K3 (Rad.cal) | 03 | 2 | 1110 | XBK5 A3+ | 2813 | FX3 | | |
| GSX-R | 1000 K4 (Rad.cal) | 04 | 2 | 1133 | XBK5 A3+ | 2813 | FX3 | | |
| GSX-R | 1000 K5 / K6 (Rad.cal) | 05-06 | 2 | 1133 | XBK5 A3+ | 2813 | FX3 | | |
| GSX-R | 1000 K7 / K8 (Rad.cal) | 07-08 | 2 | 1133 | XBK5 A3+ | 1163 | FX3 | | |
| GSX-R | 1000 K9 / L0 (Rad.cal) | 09- | 2 | 1133 | XBK5 A3+ | 1174 | FX3 | | |
| SV | 1000 S / N K3-K7 | 03-07 | 2 | 2251 | XBK5 A3+ | 2296 | FX3 | | |
| TL | 1000 S | 97-01 | 2 | 2251 | XBK5 A3+ | 2282 | FX3 | | |
| TL | 1000 R | 98-02 | 2 | 2255 | XBK5 A3+ | 2282 | FX3 | | |
| GS | 1100 GD / GZ / GLD / GLZ / GKZ | 82-83 | 1 | 2694 | A3+ | | NA | | |
| GSX | 1100 EFE / EFF / ESE | 84-86 | 2 | 2280 | A3+ | 2280 | FX3 | | |
| GSX | 1100 FJ/FK/FL/FM/FN/FP/FR (GV72A) | 88-95 | 2 | 2281 | A3+ | 2280 | FX3 | | |
| GSX | 1100 GM / GN / GP | 91-93 | 2 | 2304 | A3+ | 2281 | FX3 | | |
| GSX | 1100 G | 94-95 | 2 | 2304 | A3+ | 2389 | FX3 | | |
| GSX | 1100 G | 96- | 1 L | 2383 | A3+ | 2282 | FX3 | | |
| GSX | 1100 G | 96- | 1 R | 2384 | A3+ | | | | |
| GSX | 1100 Katana | 93- | 2 | 2246 | XBK5 A3+ | 2282 | FX3 | | |
| GSX-R | 1100 G / H / J (GV74B) | 86-88 | 2 | 2280 | A3+ | 2282 | FX3 | | |
| GSX-R | 1100 K / L / M / N (GV73B) | 89-92 | 2 | 2246 | XBK5 A3+ | 2282 | FX3 | | |
| GSX-R | 1100 WP / WR / WS / WT (GV75A) | 93-97 | 2 | 2255 | XBK5 A3+ | 2282 | FX3 | | |
| GS | 1150 EG | 86- | 2 | 2280 | A3+ | 2280 | FX3 | | |
| GS | 1150 ES | 84- | 2 | 2280 | A3+ | 2280 | FX3 | | |
| GS | 1200 SS (GV78A) | 01 | 2 | 2255 | XBK5 A3+ | 2813 | FX3 | | |
| GSF | 1200 S / N Bandit | 95-00 | 2 | 2246 | XBK5 A3+ | 2282 | FX3 | | |
| GSF | 1200 S / N Bandit ABS | 97- | 2 | 2246 | XBK5 A3+ | 2282 | FX3 | | |
| GSF | 1200 S / N Bandit K1-K5 | 01-05 | 2 | 2255 | XBK5 A3+ | 2282 | FX3 | | |
| GSF | 1200 S / N Bandit K6 | 06 | 2 | 2251 | XBK5 A3+ | 2296 | FX3 | | |
| GSF | 1200 S / N Bandit ABS K6 | 06 | 2 | 2251 | XBK5 A3+ | 2296 | FX3 | | |
| GSX | 1200 | 98-01 | 2 | 2539 | XBK5 A3+ | 2282 | FX3 | | |
| GV | 1200 GLG Madura | 85-86 | 2 | 2694 | A3+ | | NA | | |
| GSF | 1250 S / N Bandit (K7/K8/K9/L0) | 07-10 | 2 | 2251 | XBK5 A3+ | 2296 | FX3 | | |
| GSF | 1250 S / N Bandit ABS (K7/K8/K9/L0) | 07-10 | 2 | 2251 | XBK5 A3+ | 2296 | FX3 | | |
| GSF | 1250 FA Traveller | 10- | 2 | 2251 | XBK5 A3+ | 2296 | FX3 | | |
| GSX | 1300 B-king | 07 | 2 | 1177 | XBK5 A3+ | 2296 | FX3 | | |
| GSX-R | 1300 Hayabusa | 99-07 | 2 | 2255 | XBK5 A3+ | 2282 | FX3 | | |
| GSX-R | 1300 Hayabusa | 08- | 2 | 1133 | XBK5 A3+ | 1163 | FX3 | | |
| GSX | 1340 B-king | 08- | 2 | 1083 | XBK5 A3+ | 1163 | FX3 | | |
| GSX | 1400 | 01-07 | 2 | 2255 | XBK5 A3+ | 2813 | FX3 | | |
| GV | 1400 Cavalcade (Up to F/No 103764) | 86 | 2 | 2280 | A3+ | 2280 | FX3 | | |
| GV | 1400 Cavalcade (From F/No 103765) | 86-88 | 2 | 2281 | A3+ | | NA | | |
| VS | 1400 GL Intruder (VX51L) | 87-04 | 2 | 2280 | A3+ | 2280 | FX3 | | |
| VL | 1500 Intruder Legendary Classic | 98-01 | 1 | 2280 | A3+ | 2280 | FX3 | | |
| VL | 1500 Intruder Legendary Classic | 02-03 | 1 L | 2383 | A3+ | 1145 | FX3 | | |

SUZUKI

| | | | | BEST CHOICE | | OTHER CHOICE | | BEST CHOICE | |
|-----|---------------------------------|-------|-----|-------------|----------|--------------|-----|-------------|--|
| VL | 1500 Intruder Legendary Classic | 02-03 | 1 R | 2384 | A3+ | | | | |
| C | 1500 Intruder | 05-09 | 1 L | 2383 | A3+ | 1145 | FX3 | | |
| C | 1500 Intruder | 05-09 | 1 R | 2384 | A3+ | | | | |
| C90 | 1500 Boulevard | 05-09 | 1 L | 2383 | A3+ | 1145 | FX3 | | |
| C90 | 1500 Boulevard | 05-09 | 1 R | 2384 | A3+ | | | | |
| M | 1500 Intruder | 09- | 1 L | 2383 | A3+ | 2384 | FX3 | | |
| M | 1500 Intruder | 09- | 1 R | 2384 | A3+ | | | | |
| M | 1600 Intruder | 05- | 2 | 1110 | XBK5 A3+ | 2384 | FX3 | | |
| M95 | 1600 Boulevard | 05- | 2 | 1110 | XBK5 A3+ | 2384 | FX3 | | |
| VZ | 1600 Marauder | 04 | 2 | 2255 | XBK5 A3+ | 2384 | FX3 | | |
| C | 1800 R Intruder / RT Intruder | 08- | 2 | 1159 | XBK5 A3+ | 2384 | FX3 | | |
| M | 1800 R Intruder | 06-09 | 2 | 1133 | XBK5 A3+ | 2384 | FX3 | | |
| M | 1800 R2 Intruder | 08-09 | 2 | 1133 | XBK5 A3+ | 2384 | FX3 | | |
| M | 1800 RZ | 07-10 | 2 | 1133 | XBK5 A3+ | 2384 | FX3 | | |

SYM

| | | | | | | | | | |
|-----|-----------------|-------|---|------|-----|----|---|--|--|
| 125 | Cevalo B9A (4T) | 10 | 1 | 2313 | A3+ | S4 | T | | |
| 125 | Wolf Legend | 04-05 | 1 | 2621 | A3+ | | T | | |
| XS | 125 K | 07-09 | 1 | 2326 | A3+ | S4 | T | | |

THUMPSTAR

| | | | | | | | | | |
|-----|-------------|-------|---|------|----|--|------|----|--|
| 90 | Junior | 04-06 | 1 | 2696 | S4 | | 2696 | S4 | |
| 110 | Supa | 04-06 | 1 | 2696 | S4 | | 2696 | S4 | |
| 125 | Expert | 06 | 1 | 2696 | S4 | | 2696 | S4 | |
| 125 | Pro | 05-06 | 1 | 2696 | S4 | | 2696 | S4 | |
| 125 | Road Ripper | 06- | 1 | 2696 | S4 | | 2696 | S4 | |

TM

| | | | | | | | | | |
|-----|-------------------------------|-------|---|------|----------|------|-----|--|--|
| SMM | 125 Black Dream (Rim brake) | 04-07 | 1 | NA | XBK5 A3+ | 2249 | FX3 | | |
| SMM | 125 Black Dream (2T) | 08-10 | 1 | 1033 | XBK5 A3+ | 2249 | FX3 | | |
| SMR | 125 (2T) | 05-10 | 1 | 2247 | XBK5 A3+ | 2314 | FX3 | | |
| SME | 250 (4T) | 04 | 1 | 2247 | XBK5 A3+ | 2314 | FX3 | | |
| SM | 250 | 02 | 1 | 2247 | XBK5 A3+ | 2314 | FX3 | | |
| SMM | 250 (2T) | 05-10 | 1 | 2247 | XBK5 A3+ | 2314 | FX3 | | |
| SMM | 250 F (4T) | 10 | 1 | 1033 | XBK5 A3+ | 2314 | FX3 | | |
| SMR | 250 (2T) | 05-08 | 1 | 2247 | XBK5 A3+ | 2314 | FX3 | | |
| SMR | 250 F (4T) | 10 | 1 | 1033 | XBK5 A3+ | 2314 | FX3 | | |
| SMM | 300 (2T) | 05-10 | 1 | 2247 | XBK5 A3+ | 2249 | FX3 | | |
| SMR | 300 (2T) | 05-10 | 1 | 2247 | XBK5 A3+ | 2314 | FX3 | | |
| SME | 400 (4T) | 04 | 1 | 2247 | XBK5 A3+ | 2314 | FX3 | | |
| SMM | 400 (4T) (Rim brake) | 04 | 1 | NA | XBK5 A3+ | 2249 | FX3 | | |
| SM | 400 | 02-03 | 1 | 2247 | XBK5 A3+ | 2314 | FX3 | | |
| SMM | 450 F Black Dream ES | 08-10 | 1 | 1033 | XBK5 A3+ | 2249 | FX3 | | |
| SMR | 450 FES | 05-09 | 1 | 2247 | XBK5 A3+ | 2314 | FX3 | | |
| SMR | 450 F (4T) | 10 | 1 | 1033 | XBK5 A3+ | 2314 | FX3 | | |
| SMX | 450 F | 05-10 | 1 | 1033 | XBK5 A3+ | 2314 | FX3 | | |
| SMM | 530 F Black Dream (Rim brake) | 04-07 | 1 | NA | XBK5 A3+ | 2249 | FX3 | | |
| SM | 530 | 02-03 | 1 | 2247 | XBK5 A3+ | 2314 | FX3 | | |
| SME | 530 (4T) | 04 | 1 | 2247 | XBK5 A3+ | 2314 | FX3 | | |
| SMM | 530 F Black Dream ES | 08-10 | 1 | 1033 | XBK5 A3+ | 2249 | FX3 | | |
| SMR | 530 F | 10 | 1 | 1033 | XBK5 A3+ | 2314 | FX3 | | |
| SMR | 530 F ES | 05-09 | 1 | 2247 | XBK5 A3+ | 2314 | FX3 | | |
| SMX | 530 F | 05-10 | 1 | 1033 | XBK5 A3+ | 2314 | FX3 | | |
| SMX | 660 F | 04 | 1 | 2247 | XBK5 A3+ | 2314 | FX3 | | |
| SMX | 660 F | 05-10 | 1 | 1033 | XBK5 A3+ | 2314 | FX3 | | |

TRIUMPH

| | | | | | | | | | |
|-------|-----------------------------|-------|-----|------|----------|------|-----|--|--|
| 600 | Daytona | 03-04 | 2 | 2246 | XBK5 A3+ | 2298 | FX3 | | |
| 600 | Speed Four | 02-05 | 2 | 2246 | XBK5 A3+ | 2298 | FX3 | | |
| 600 | TT | 00-03 | 2 | 2246 | XBK5 A3+ | 2298 | FX3 | | |
| 650 | Daytona | 05 | 2 | 2246 | XBK5 A3+ | 2298 | FX3 | | |
| 675 | Daytona (Rad.cal) | 06-08 | 2 | 1083 | XBK5 A3+ | 2298 | FX3 | | |
| 675 | Daytona (Rad.cal) | 09- | 2 | 1209 | XBK5 | 2298 | FX3 | | |
| 675 | Street Triple | 07- | 2 | 2256 | XBK5 A3+ | 2298 | FX3 | | |
| 675 | Street Triple R | 09- | 2 | 1083 | XBK5 A3+ | 2298 | FX3 | | |
| 750 | Bonneville T140 | 85-88 | 2 | 2332 | A3+ | 2332 | FX3 | | |
| 750 | Daytona | 91-92 | 2 | 2246 | XBK5 A3+ | 2326 | FX3 | | |
| 750 | Trident | 91-98 | 1 L | 2326 | A3+ | 2326 | FX3 | | |
| 750 | Trident | 91-98 | 1 R | 2288 | A3+ | | | | |
| 800 | America | 03-06 | 1 | 2256 | A3+ | 2288 | FX3 | | |
| 800 | Bonneville | 01-04 | 1 | 2256 | A3+ | 2288 | FX3 | | |
| 800 | Bonneville / America / T100 | 02- | 1 | 2256 | A3+ | 2288 | FX3 | | |
| 800 | Speedmaster | 03-04 | 2 | 2256 | A3+ | 2288 | FX3 | | |
| 900 | Adventurer | 96- | 1 | 2256 | A3+ | 2313 | FX3 | | |
| 900</ | | | | | | | | | |

YAMAHA

| | | | | BEST CHOICE | | OTHER CHOICE | | BEST CHOICE | |
|------|-------------------------|---------|---|-------------|------|--------------|------|-------------|-----|
| TZR | 150 (4AP2) | 00 - | 1 | 2546 | A3+ | S4 | | 2301 | RX3 |
| DT | 200 R | 85 - 87 | 1 | 2284 | A3+ | S4 | | | |
| DT | 200 R | 89 | 1 | 2284 | A3+ | S4 | 2284 | RX3 | |
| DT | 200 WR | 91 - 93 | 1 | 2288 | A3+ | S4 | 2299 | RX3 | |
| SDR | 200 | 87 - 89 | 1 | 2301 | A3+ | S4 | 2301 | RX3 | |
| TW | 200 | 01 - 02 | 1 | 2828 | S4 | | T | | |
| ST | 225 Bronco | 97 | 1 | 2828 | S4 | | T | | |
| TW | 225 | 03 | 1 | 2828 | S4 | | T | | |
| XT | 225 Serrow | 86 - 93 | 1 | 2284 | A3+ | S4 | T | | |
| XT | 225 Serrow W | 93 - 98 | 1 | 2284 | A3+ | S4 | 2299 | RX3 | |
| XT | 225 | 05 - | 1 | 2828 | S4 | | T | | |
| DT | 230 Lanza | 97 - 98 | 1 | 2288 | A3+ | S4 | 2299 | RX3 | |
| XV | 240 Virago | 92 - | 1 | 2802 | A3+ | S4 | T | | |
| FZ | 250 Fazer N / S | 85 - 86 | 2 | 2283 | A3+ | S4 | T | | |
| FZR | 250 | 87 - 88 | 2 | 2305 | XBK5 | A3+ | 2301 | RX3 | |
| FZR | 250 R | 89 - | 2 | 2361 | A3+ | | 2301 | RX3 | |
| FZX | 250 Zeal | 91 - 92 | 1 | 2391 | A3+ | S4 | 2301 | RX3 | |
| R1-Z | 250 | 90 - | 1 | 2361 | A3+ | | 2301 | RX3 | |
| RD | 250 LC | 81 - 82 | 1 | 2807 | A3+ | S4 | T | | |
| RD | 250 LC | 83 - | 1 | 2802 | A3+ | S4 | 2283 | RX3 | |
| RZ | 250 (4L3) | 80 - | 1 | 2802 | A3+ | S4 | T | | |
| RZ | 250 R (29L) | 80 - | 2 | 2802 | A3+ | S4 | 2301 | RX3 | |
| RZ | 250 R (1AR/1XG) | 80 - | 2 | 2301 | A3+ | S4 | 2301 | RX3 | |
| RZ | 250 RR (5L) | 88 - | 2 | 2301 | A3+ | | 2301 | RX3 | |
| SR | 250 Classic | 96 - 00 | 1 | 2802 | A3+ | S4 | T | | |
| SRV | 250 (4DN1-6) | 92 - 97 | 1 | 2391 | A3+ | S4 | T | | |
| SRX | 250 T / TC | 84 - 87 | 1 | 2301 | A3+ | | T | | |
| TDR | 250 | 88 - 92 | 1 | 2305 | XBK5 | A3+ | 2301 | RX3 | |
| TZ | 250 GP / A / D | 90 - 95 | 2 | 2246 | XBK5 | A3+ | 2269 | RX3 | |
| TZ | 250 | 97 - | 2 | 2361 | XBK5 | | 2269 | RX3 | |
| TZR | 250 | 87 - 92 | 2 | 2305 | XBK5 | A3+ | 2301 | RX3 | |
| TZR | 250 / SP / R / RS / SPR | 89 - 96 | 2 | 2361 | XBK5 | A3+ | 2301 | RX3 | |
| WR | 250 R | 08 - | 1 | 2300 | A3+ | | 1103 | RX3 | |
| WR | 250 X Supermotard | 08 - | 1 | 2256 | A3+ | S4 | 1103 | RX3 | |
| XG | 250 Tricker | 04 - 06 | 1 | 2828 | S4 | | 2299 | RX3 | |
| XS | 250 C | 77 - 78 | 1 | 2847 | A3+ | S4 | 2847 | RX3 | |
| XS | 250 D / E | 79 - 81 | 1 | 2847 | A3+ | S4 | T | | |
| XT | 250 X Supermotard | 06 - 08 | 1 | 2828 | S4 | | 2299 | RX3 | |
| XV | 250 Virago | 88 - 90 | 1 | 2802 | A3+ | S4 | T | | |
| XV | 250 Virago | 91 - 92 | 1 | 2392 | A3+ | S4 | T | | |
| XV | 250 Virago | 93 - 95 | 1 | 2802 | A3+ | S4 | T | | |
| XV | 250 Virago S | 95 - 00 | 1 | 2546 | A3+ | S4 | T | | |
| XVS | 250 Dragstar | 01 - 03 | 1 | 2546 | A3+ | S4 | T | | |
| YBR | 250 | 07 - | 1 | 2326 | A3+ | | T | | |
| RD | 350 LC (4L0) | 81 - 82 | 2 | 2807 | A3+ | | T | | |
| RD | 350 YPVS | 83 - 84 | 2 | 2802 | A3+ | | 2283 | RX3 | |
| RD | 350 N / F / F2 | 85 - 92 | 2 | 2301 | A3+ | | 2301 | RX3 | |
| RD | 350 R | 92 - 95 | 2 | 2301 | A3+ | | 2301 | RX3 | |
| RZ | 350 L / N / NC | 84 - 85 | 2 | 2802 | A3+ | | 2283 | RX3 | |
| RZ | 350 F | 86 - 88 | 2 | 2301 | A3+ | | 2301 | RX3 | |
| XT | 350 | 85 - 90 | 1 | 2284 | A3+ | | T | | |
| XT | 350 B-H | 91 - 95 | 1 | 2284 | A3+ | | T | | |
| XS | 360 C / D | 76 - | 1 | 2847 | A3+ | S4 | 2847 | RX3 | |
| FZ | 400 N | 85 | 2 | 2283 | A3+ | S4 | 2301 | RX3 | |
| FZ | 400 R | 86 - 87 | 2 | 2539 | XBK5 | A3+ | 2301 | RX3 | |
| FZR | 400 Genesis (1WG) | 86 | 2 | 2283 | A3+ | | 2301 | RX3 | |
| FZR | 400 R SP (2TK-Exup) | 87 | 2 | 2305 | XBK5 | A3+ | 2301 | RX3 | |
| FZR | 400 (3EN1) | 88 | 2 | 2305 | XBK5 | A3+ | 2301 | RX3 | |
| FZR | 400 R (3EN2) | 89 | 2 | 2305 | XBK5 | A3+ | 2301 | RX3 | |
| FZR | 400 RR (3TJ1 / 4DX) | 89 - 92 | 2 | 2361 | XBK5 | A3+ | 2301 | RX3 | |
| FZR | 400 RR SP (3TJ1 / 4DX) | 91 - 94 | 2 | 2361 | XBK5 | A3+ | 2301 | RX3 | |
| SRX | 400 (1JL) | 85 - 86 | 1 | 2283 | A3+ | | 2301 | RX3 | |
| SRX | 400 (3VN) | 90 - 96 | 1 | 2305 | XBK5 | A3+ | 2301 | RX3 | |
| XJ | 400 | 82 | 2 | 2802 | A3+ | | 2283 | RX3 | |
| XJ | 400 S Diversion | 91 - | 1 | 2391 | A3+ | | 2301 | RX3 | |
| XJR | 400 R | 93 - 96 | 2 | 2546 | XBK5 | A3+ | 2301 | RX3 | |
| XJR | 400 R (Brembo calipers) | 95 - 99 | 2 | 2539 | XBK5 | A3+ | 2301 | RX3 | |
| XJR | 400 Z | 02 - | 2 | 2361 | XBK5 | A3+ | 1066 | RX3 | |
| XS | 400 C / E / F | 77 - 79 | 1 | 2847 | A3+ | S4 | 2847 | RX3 | |
| XS | 400 DOHC | 82 | 1 | 2802 | A3+ | S4 | T | | |
| XS | 400 RJ / RK / J / K | 83 - 83 | 1 | 2802 | A3+ | | T | | |
| XS | 400 Z | 83 - | 1 | 2283 | A3+ | | 2283 | RX3 | |
| XT | 400 Artesia | 91 - | 1 | 2360 | A3+ | | 2284 | RX3 | |
| XV | 400 Virago | 88 - | 1 | 2392 | A3+ | S4 | T | | |
| XVS | 400 Drag Star | 96 - | 1 | 2391 | A3+ | S4 | T | | |
| RD | 500 | 83 | 2 | 2283 | A3+ | S4 | 2283 | RX3 | |
| RD | 500 LC (RVZ500R) | 84 - 86 | 2 | 2283 | A3+ | | 2301 | RX3 | |
| RZ | 500 | 84 - 86 | 2 | 2283 | A3+ | | 2301 | RX3 | |
| SR | 500 | 78 - 82 | 1 | 2847 | A3+ | S4 | T | | |

YAMAHA

| | | | | BEST CHOICE | | OTHER CHOICE | | BEST CHOICE | |
|-------|---------------------------------|---------|-----|-------------|------|--------------|------|-------------|--|
| XS | 500 C / D | 78 - 79 | 1 | 2847 | A3+ | S4 | 2847 | RX3 | |
| XS | 500 DOHC | 82 - | 1 | 2802 | A3+ | | T | | |
| XV | 500 | 83 - | 1 | 2802 | A3+ | | T | | |
| XV | 535 Virago | 88 - 94 | 1 | 2392 | A3+ | S4 | T | | |
| XV | 535 Virago / S Virago | 95 - 03 | 1 | 2391 | A3+ | S4 | T | | |
| XJ | 550 | 81 - 84 | 2 | 2807 | A3+ | | T | | |
| XJ | 550 H/J/K/RH/RJ/RK Maxim / Seca | 81 - 83 | 1 | 2807 | A3+ | | T | | |
| XZ | 550 | 82 - 84 | 2 | 2802 | A3+ | | T | | |
| FJ | 600 | 84 - | 2 | 2283 | A3+ | | 2283 | RX3 | |
| FZ | 600 | 87 - 88 | 2 | 2283 | A3+ | | 2301 | RX3 | |
| FZR | 600 | 89 | 2 | 2283 | A3+ | | 2283 | RX3 | |
| FZR | 600 / R | 90 - 95 | 2 | 2311 | XBK5 | A3+ | 2283 | RX3 | |
| FZS | 600 Fazer | 98 - 03 | 2 | 2361 | XBK5 | A3+ | 2301 | RX3 | |
| FZ6 | 600 N / Fazer | 04 - 07 | 2 | 2546 | XBK5 | A3+ | 2296 | RX3 | |
| FZ6 | 600 N / Fazer ABS | 06 - 07 | 2 | 2546 | XBK5 | A3+ | 2296 | RX3 | |
| FZ6 | 600 N / Fazer S2 | 07 - 09 | 2 | 2361 | XBK5 | A3+ | 2296 | RX3 | |
| FZ6 | 600 N / Fazer S2 ABS | 08 | 2 | 2361 | XBK5 | A3+ | 2296 | RX3 | |
| SRX | 600 (1JK) | 85 - 87 | 2 | 2301 | A3+ | | 2301 | RX3 | |
| SRX | 600 (3SX) | 90 | 1 | 2305 | XBK5 | A3+ | 2301 | RX3 | |
| TT | 600 E | 94 - 01 | 1 | 2352 | A3+ | | 2353 | RX3 | |
| TT | 600 E (Belgarda) | 94 - 95 | 1 | 2352 | A3+ | | 2299 | RX3 | |
| TT | 600 K (Belgarda) | 93 - 95 | 1 | 2352 | A3+ | | 2299 | RX3 | |
| TT | 600 K (From 4GV 003404) | 95 - 96 | 1 | 2352 | A3+ | | 2353 | RX3 | |
| TT | 600 R (5CH1 / 5CH2 / 5CH3) | 97 - 02 | 1 | 2352 | A3+ | | 2353 | RX3 | |
| TT | 600 RE (5CH5) | 04 | 1 | 2352 | A3+ | | 2353 | RX3 | |
| XJ | 600 | 83 - 91 | 2 | 2283 | A3+ | | 2283 | RX3 | |
| XJ | 600 N / S Diversion | 92 - 97 | 1 | 2391 | A3+ | | 2301 | RX3 | |
| XJ | 600 N / S Diversion | 98 - 03 | 2 | 2546 | A3+ | | 2301 | RX3 | |
| XJ6 | 600 / ABS | 09 - | 2 | 2546 | A3+ | | 2298 | RX3 | |
| XJ6 | 600 Diversion / ABS | 09 - | 2 | 2546 | A3+ | | 2298 | RX3 | |
| XJ6 | 600 Diversion F / ABS | 10 - | 2 | 2546 | A3+ | | 2298 | RX3 | |
| XT | 600 | 84 - 86 | 1 | 2802 | A3+ | | T | | |
| XT | 600 | 87 - 89 | 1 | 2393 | A3+ | | 2284 | RX3 | |
| XT | 600 E / K | 90 - 03 | 1 | 2360 | A3+ | | 2284 | RX3 | |
| XT | 600 Z Ténére | 84 | 1 | 2802 | A3+ | | T | | |
| XT | 600 Ténére | 85 - 88 | 1 | 2393 | A3+ | | T | | |
| XT | 600 Z Ténére | 88 - 90 | 1 | 2393 | A3+ | | 2284 | RX3 | |
| YX | 600 Radian | 86 - 90 | 2 | 2283 | A3+ | | T | | |
| YZF | 600 R Thunder Cat | 96 - 03 | 2 | 2361 | XBK5 | A3+ | 2283 | RX3 | |
| YZF | 600 R6 | 99 - 02 | 2 | 2361 | XBK5 | A3+ | 2828 | RX3 | |
| YZF | 600 R6 | 03 - 05 | 2 | 2361 | XBK5 | A3+ | 2296 | RX3 | |
| YZF | 600 R6 | 06 - 09 | 2 | 2361 | XBK5 | A3+ | 2296 | RX3 | |
| YZF | 600 R6 | 10 - | 2 | 2361 | XBK5 | A3+ | 2296 | RX3 | |
| XJ | 650 | 80 - 84 | 2 | 2847 | A3+ | | T | | |
| XJ | 650 RJ Seca | 82 | 2 | 2847 | A3+ | | T | | |
| XJ | 650 LK Seca | 83 | 2 | 2802 | A3+ | | T | | |
| XJ | 650 Turbo | 82 | 2 | 2802 | A3+ | | T | | |
| XS | 650 D1E / F / F2 | 77 - 79 | 2 | 2847 | A3+ | | T | | |
| XS | 650 SE | 79 - 80 | 1 | 2847 | A3+ | | 2847 | RX3 | |
| XS | 650 SE | 81 | 1 | 2847 | A3+ | | T | | |
| XS | 650 G / H / J / K | 80 - 82 | 2 | 2847 | A3+ | | T | | |
| XS | 650 SJ / SK Heritage | 82 - | 1 | 2847 | A3+ | | T | | |
| XVS | 650 Drag Star | 97 - 04 | 1 | 2391 | A3+ | | T | | |
| XVS | 650 A Drag Star Classic | 98 - 07 | 1 | 2391 | A3+ | | T | | |
| MT-03 | 660 | 06 - | 2 | 2546 | A3+ | | 2353 | RX3 | |
| SZR | 660 | 96 - 97 | 1 | 2247 | XBK5 | A3+ | 2249 | RX3 | |
| XT | 660 R | 04 - | 1 | 2396 | A3+ | | 2353 | RX3 | |
| XT | 660 X Supermotard | 04 - | 1 | 2539 | XBK5 | A3+ | 2353 | RX3 | |
| XT | 660 Z Ténére | 08 - | 2 | 2352 | A3+ | | 2353 | RX3 | |
| XTZ | 660 Ténére | 91 - 98 | 1 | 2360 | A3+ | | 2284 | RX3 | |
| FZ | 700 | 87 - | 2 | 2283 | A3+ | | 2283 | RX3 | |
| FZX | 700 Fazer | 87 - | 2 | 2283 | A3+ | | 2283 | RX3 | |
| XJ | 700 / Maxim | 85 - | 2 | 2283 | A3+ | | T | | |
| XV | 700 Virago | 84 - | 2 | 2283 | A3+ | | T | | |
| FZ | 750 | 85 - 88 | 2 | 2283 | A3+ | | 2283 | RX3 | |
| FZ | 750 | 89 - 91 | 2 | 2305 | XBK5 | A3+ | 2283 | RX3 | |
| FZR | 750 R (OW01) | 89 - 90 | 2 | 2246 | XBK5 | A3+ | 2283 | RX3 | |
| FZR | 750 R Genesis | 87 - 88 | 2 | 2305 | XBK5 | A3+ | 2283 | RX3 | |
| FZX | 750 Fazer | 86 - | 2 | 2283 | A3+ | | 2283 | RX3 | |
| XJ | 750 RH / RJ / RK / Seca / Maxim | 81 - 83 | 2 | 2807 | A3+ | | T | | |
| XJ | 750 | 82 - 84 | 2 | 2807 | A3+ | | T | | |
| XS | 750 | 77 - 79 | 2 | 2847 | A3+ | | 2847 | RX3 | |
| XS | 750 SE | 79 - 80 | 2 | NA | | | 2847 | RX3 | |
| XTZ | 750 Super Ténére | 89 - 94 | 1 L | 2288 | A3+ | | 2326 | RX3 | |
| XTZ | 750 Super Ténére | 89 - 94 | 1 R | 2326 | A3+ | | T | | |
| XV | 750 Virago | 89 - 93 | 2 | 2283 | A3+ | | T | | |
| XV | 750 Virago | 94 - 97 | 2 | 2391 | A3+ | | T | | |
| YZF | 750 R / SP | 93 - 97 | 2 | 2254 | XBK5 | A3+ | 2283 | RX3 | |
| YZF | 750 R7 (OW02) | 99 - 01 | 2 | 2361 | XBK5 | A3+ | | | |



YAMAHA

BEST CHOICE

OTHER CHOICE

BEST CHOICE

| Model | Year | Configuration | Quantity | Part No. | Material | Other Part No. | Material |
|----------------------------------------|---------|---------------|----------|----------|----------|----------------|----------|
| YZF 750 R7 (OW02) "Race Kit" | 99 - 01 | 2 | 2899 | XBK5 | NA | | |
| FZ8 800 | 10 - | 2 | 2361 | XBK5 A3+ | 2296 | RX3 | |
| FZ8S 800 Fazer | 10 - | 2 | 2361 | XBK5 A3+ | 2296 | RX3 | |
| TDM 850 | 91 - 95 | 2 | 2305 | XBK5 A3+ | 2283 | RX3 | |
| TDM 850 | 96 - 01 | 2 | 2311 | XBK5 A3+ | 2283 | RX3 | |
| TRX 850 | 96 - 99 | 2 | 2305 | XBK5 A3+ | 2283 | RX3 | |
| TRX 850 (Japan models) (Brembo Cal.) | 96 - 99 | 2 | 2539 | XBK5 A3+ | 2283 | RX3 | |
| XS 850 | 80 | 2 | 2847 | A3+ | 2847 | RX3 | |
| TDM 900 | 02 - | 2 | 2361 | XBK5 A3+ | 1084 | RX3 | |
| TDM 900 ABS | 05 - | 2 | 2361 | XBK5 A3+ | 1084 | RX3 | |
| XJ 900 / F | 83 - 93 | 2 | 2283 | A3+ | 2283 | RX3 | |
| XJ 900 S Diversion | 94 - 03 | 2 | 2391 | A3+ | 2283 | RX3 | |
| XV 920 J Virago | 82 | 2 | 2807 | A3+ | T | | |
| XVS 950 A Midnight Star | 09 - | 1 | 2391 | A3+ | 1084 | RX3 | |
| FZR 1000 Genesis | 87 - 89 | 2 | 2305 | XBK5 A3+ | 2283 | RX3 | |
| FZR 1000 EXUP | 89 - 90 | 2 | 2311 | XBK5 A3+ | 2283 | RX3 | |
| FZR 1000 EXUP | 91 - 93 | 2 | 2309 | XBK5 A3+ | 2283 | RX3 | |
| FZR 1000 EXUP | 94 - 95 | 2 | 2254 | XBK5 A3+ | 2283 | RX3 | |
| FZS 1000 Fazer | 01 - 05 | 2 | 2361 | XBK5 A3+ | 1066 | RX3 | |
| FZ-1 1000 N / Fazer | 06 - | 2 | 2361 | XBK5 A3+ | 2296 | RX3 | |
| FZ-1 1000 N / Fazer ABS | 08 - | 2 | 2361 | XBK5 A3+ | 2296 | RX3 | |
| GTS 1000 / ABS | 93 - 99 | 1 | 2362 | A3+ | 2283 | RX3 | |
| XV 1000 TR1 | 81 - | 2 | 2847 | A3+ | T | | |
| XV 1000 Virago / SE Virago | 84 - | 2 | 2283 | A3+ | T | | |
| YZF 1000 R Thunder Ace | 96 - 01 | 2 | 2361 | XBK5 A3+ | 2283 | RX3 | |
| YZF 1000 R1 | 98 - 01 | 2 | 2361 | XBK5 A3+ | 2713 | RX3 | |
| YZF 1000 R1 | 02 - 03 | 2 | 2361 | XBK5 A3+ | 2828 | RX3 | |
| YZF 1000 R1 / R1 SP | 04 - 06 | 2 | 2361 | XBK5 A3+ | 2296 | RX3 | |
| YZF 1000 R1 (Rad.cal) | 07 - 08 | 2 | 1180 | XBK5 A3+ | 2296 | RX3 | |
| YZF 1000 R1 (Rad.cal) | 09 - | 2 | 1180 | XBK5 A3+ | 2296 | RX3 | |
| BT 1100 Bulldog | 02 - 06 | 2 | 2361 | A3+ | 2283 | RX3 | |
| FJ 1100 | 84 - 85 | 2 | 2283 | A3+ | 2283 | RX3 | |
| XJ 1100 Maxim | 81 - | 2 | 2807 | A3+ | NA | | |
| XS 1100 | 78 - 80 | 1 | 2847 | A3+ | 2847 | RX3 | |
| XS 1100 S | 81 | 2 | 2807 | A3+ | 2847 | RX3 | |
| XV 1100 Virago | 86 - 93 | 2 | 2283 | A3+ | T | | |
| XV 1100 Virago | 94 - 98 | 2 | 2391 | A3+ | T | | |
| XV 1100 Virago | 99 | 2 | 2546 | A3+ | 2283 | RX3 | |
| XVS 1100 Dragstar / A Dragstar Classic | 99 - 06 | 2 | 2546 | A3+ | 2283 | RX3 | |
| XVS 1100 V-Star Custom | 05 - | 2 | 2546 | A3+ | 2283 | RX3 | |
| FJ 1200 (ITX Type) | 86 - 87 | 2 | 2283 | A3+ | 2283 | RX3 | |
| FJ 1200 (3CV/CXW Type) | 88 - 95 | 2 | 2305 | XBK5 A3+ | 2283 | RX3 | |
| FJ 1200 A ABS | 91 - 95 | 2 | 2311 | XBK5 A3+ | 2283 | RX3 | |
| XJR 1200 / SP | 95 - 98 | 2 | 2305 | XBK5 A3+ | 2283 | RX3 | |
| XJR 1200 (Japan models) (Brembo Cal.) | 95 - 98 | 2 | 2539 | XBK5 A3+ | 2283 | RX3 | |
| XT 1200 Z Super Ténéré (ABS/UBS) | 10 - | 2 | 2361 | XBK5 A3+ | 1084 | RX3 | |
| XV 1200 V-Max | 85 - 92 | 2 | 2283 | A3+ | 2283 | RX3 | |
| XV 1200 V-Max | 93 - 01 | 2 | 2311 | XBK5 A3+ | 2283 | RX3 | |
| XVZ 1200 TD Venture Royale | 85 | 2 | 2283 | A3+ | 2283 | RX3 | |
| FJR 1300 | 01 - 02 | 2 | 2361 | XBK5 A3+ | 1084 | RX3 | |
| FJR 1300 / ABS | 03 - 05 | 2 | 2361 | XBK5 A3+ | 1084 | RX3 | |
| FJR 1300 A / AS ABS | 06 - | 2 | 1175 | XBK5 A3+ | 1084 | RX3 | |
| XJR 1300 (Japan models) (Brembo Cal.) | 98 - 99 | 2 | 2539 | XBK5 A3+ | 2283 | RX3 | |
| XJR 1300 / SP | 99 - 01 | 2 | 2361 | XBK5 A3+ | 2283 | RX3 | |
| XJR 1300 | 02 - 10 | 2 | 2361 | XBK5 A3+ | 1066 | RX3 | |
| XVS 1300 A Midnight Star | 07 - | 2 | 2546 | A3+ | 1084 | RX3 | |
| XVZ 1300 A Royal Star / Tour Classic | 96 - 01 | 2 | 2253 | A3+ | 2305 | RX3 | |
| XVZ 1300 TF Venture Star | 99 - 01 | 2 | 2391 | A3+ | 2305 | RX3 | |
| XVZ 1300 Venture Royale | 86 - 89 | 2 | 2253 | A3+ | 2305 | RX3 | |
| XVZ 1300 Venture Royale | 90 - 95 | 2 | 2253 | A3+ | 2305 | RX3 | |
| XV 1600 A Wild Star | 99 - 04 | 2 | 2391 | A3+ | 2305 | RX3 | |
| MT-01 1700 (4 piston caliper) | 05 - 06 | 2 | 2361 | XBK5 A3+ | 2313 | RX3 | |
| MT-01 1700 (6 piston caliper) | 07 - 09 | 2 | 1180 | XBK5 A3+ | 2313 | RX3 | |
| MT-01 1700 S (6 piston caliper) | 09 | 2 | 1180 | XBK5 A3+ | 2313 | RX3 | |
| XV 1700 A / PC Road Star | 02 - 05 | 2 | 2361 | XBK5 A3+ | 1084 | RX3 | |
| XV 1700 Y V-Max | 09 - | 2 | 1180 | XBK5 A3+ | 1084 | RX3 | |
| XV 1900 A Midnight Star | 06 - | 2 | 2361 | XBK5 A3+ | 1084 | RX3 | |

1 - 2 - 4 = Nombre de jeux / Number of sets / Anzahl Sets Numero blister / Numero des juegos
 L = Gauche / Left / Links / Sinistra / Izquierda
 R = Droite / Right / Rechts / Destra / Derecha
 NA = Non Attribué / Not Available / Nicht verfügbar / Non disponibile / No disponible

BEST CHOICE = Notre meilleur choix / Empfehlung
 Mescola consigliata / Pastilla recomendada

OTHER CHOICE = Autre possibilité / Weitere Auswahlmöglichkeiten
 Altra mescola / Otra posibilidad



Etriers / Calipers / Steibügel / Pinza di freno / Pinza de freno

Route / Street / Straße / Strada / Carretera

| | | ROUTE ROAD | SPORT | RACING | |
|-------------------------------------------------|---|------------|-------|--------|-----|
| AP RACING | | | | | |
| 6 Piston Caliper - Road/Racing | 1 | 2720 | | XBK5 | C59 |
| CP 2868 Caliper - Road/Racing | 1 | 2950 | | XBK5 | C59 |
| CP 4226 Rear Caliper - Racing | 1 | 2922 | | | |
| BERINGER | | | | | |
| 2 Piston Caliper - Road | 1 | 2307 | A3+ | XBK5 | |
| 4 Piston Caliper - Road/Racing | 1 | 2251 | A3+ | XBK5 | C59 |
| 6 Piston Caliper - Road/Racing | 1 | 2404 | A3+ | XBK5 | C59 |
| 6 Piston Caliper - Road | 3 | 2307 | A3+ | XBK5 | |
| BILLET | | | | | |
| 6 Piston Caliper - Road/Racing | 3 | 2249 | A3+ | XBK5 | C59 |
| BREMBO | | | | | |
| 4 Piston Caliper - Racing | 1 | 2933 | | | C59 |
| P 30 A - Road | 1 | 2307 | A3+ | XBK5 | |
| P 32 A - Road | 2 | 2377 | A3+ | | |
| P32x36 Monobloc Caliper - Racing | 1 | 2329 | | XBK5 | C59 |
| P4 30x30 Double pin - Road/Racing | 1 | 2539 | A3+ | XBK5 | C59 |
| P4 34x30 Single pin - Road/Racing | 1 | 2247 | A3+ | XBK5 | C59 |
| P4 34x34 Gold - Road/Racing | 2 | 1033 | A3+ | XBK5 | C59 |
| P4 34x34 Radial Caliper - Road/Racing | 2 | 1033 | A3+ | XBK5 | C59 |
| P4 Radial 2 Pieces Caliper - Racing | 1 | 2329 | | XBK5 | C59 |
| P4 Radial Monobloc Caliper - Racing | 1 | 2329 | | XBK5 | C59 |
| ISR | | | | | |
| 2 Piston Caliper (22-027/028/029) - Road/Racing | 2 | 2249 | A3+ | XBK5 | C59 |
| NISSIN | | | | | |
| 4 Piston Caliper - Road/Racing | 1 | 2246 | A3+ | XBK5 | C59 |
| 4 Piston Radial Caliper - Road/Racing | 1 | 1083 | A3+ | XBK5 | C59 |
| 6 Piston Caliper - Road/Racing | 1 | 2404 | A3+ | XBK5 | C59 |
| 6 Piston Caliper - Road/Racing | 1 | 2899 | A3+ | XBK5 | C59 |
| 6 Piston Radial Caliper - Endurance | 1 | 2931 | | | C59 |
| PERFORMANCE MACHINE | | | | | |
| Caliper 112x6 QC = 0051-2901/2902 - Road | 1 | 2899 | A3+ | XBK5 | C59 |
| Caliper 125x2 = 0052-2100 - Road | 1 | 2377 | A3+ | | |
| Caliper 125x4S = 0052-2200 - Road | 2 | 2377 | A3+ | | |
| Caliper 125x4SL = 0052-2300 - Road | 2 | 2377 | A3+ | | |
| Caliper 125x6 - Road | 1 | 2369 | A3+ | | |
| Caliper 137x6 - Road | 1 | 2369 | A3+ | | |
| PVM | | | | | |
| 4 Piston Caliper - Racing | 1 | 2933 | | | C59 |
| 6 Piston Caliper - Racing | 1 | 2584 | | XBK5 | C59 |
| Radial Caliper - Racing | 2 | 1075 | | | C59 |
| SPIEGLER | | | | | |
| 4 Piston Caliper - Road/Racing | 1 | 2920 | | XBK5 | C59 |
| 8 Piston Caliper - Road/Racing | 1 | 2586 | | XBK5 | C59 |
| 8 Piston Caliper - Road/Racing | 1 | 2919 | | XBK5 | C59 |



1 - 2 - 4 = Nombre de jeux / Number of sets / Anzahl Sets Numero blister / Numero des juegos
 L = Gauche / Left / Links / Sinistra / Izquierda
 R = Droite / Right / Rechts / Destra / Derecha
 NA = Non Attribué / Not Available / Nicht verfügbar / Non disponibile / No disponible

BEST CHOICE = Notre meilleur choix / Empfehlung
 Mescola consigliata / Pastilla recomandada

OTHER CHOICE = Autre possibilité / Weitere Auswahlmöglichkeiten
 Otra mescola / Otra posibilidad



Racing



AP RACING

| | | | | |
|--------------------------------|---|------|-----|--|
| 6 Piston Caliper - Road/Racing | 1 | 2720 | C59 | |
| CP 2868 Caliper - Road/Racing | 1 | 2950 | C59 | |

APRILIA

| | | | | | | |
|----------------------------|---------|---|------|-----|------|-----|
| RS 125 / Extrema / Replica | 93 - 98 | 1 | 2398 | C59 | 1167 | RX3 |
| RS 125 R Piste | 04 - | 1 | 2398 | C59 | 1167 | RX3 |
| RS 250 | 95 - 96 | 1 | 2247 | C59 | 2249 | RX3 |
| RS 250 | 97 - 02 | 2 | 2539 | C59 | 2249 | RX3 |
| RS 250 R Piste | 04 - | 2 | 2539 | C59 | 2249 | RX3 |
| SXV 450 | 06 - | 1 | NA | | 1103 | RX3 |
| SXV 450 Van den Bosh Rep. | 08 - | 1 | 2329 | C59 | 1103 | RX3 |
| SXV 550 | 06 - | 1 | NA | | 1103 | RX3 |
| SXV 550 Van den Bosh Rep. | 08 - | 1 | 2329 | C59 | 1103 | RX3 |
| RSV 1000 Factory Pista | 04 - | 2 | 1033 | C59 | 2827 | RX3 |
| RSV 1000 Nera | 04 - | 2 | 1033 | C59 | 2827 | RX3 |
| RSV 1000 R | 00 | 2 | 2539 | C59 | 2827 | RX3 |
| RSV 1000 R | 01 - 02 | 2 | 1033 | C59 | 2827 | RX3 |
| RSV 1000 R | 03 - | 2 | 1033 | C59 | 2827 | RX3 |
| RSV 1000 R Factory Replica | 04 - | 2 | 1033 | C59 | 2827 | RX3 |
| RSV 1000 SP | 00 - | 2 | 2539 | C59 | 2827 | RX3 |
| RSV 1000 | 97 - 01 | 2 | 2539 | C59 | 2827 | RX3 |
| RSV 1000 | 02 - | 2 | 1033 | C59 | 2827 | RX3 |
| RSV4 1000 Factory | 09 - | 2 | 1185 | C59 | 2827 | RX3 |
| RSV4 1000 R | 10 - | 2 | 1185 | C59 | 2827 | RX3 |

BENELI

| | | | | | | |
|--------------------------------|---------|---|------|-----|------|-----|
| BX 449 Supermotard | 08 - | 2 | 1033 | C59 | 2353 | RX3 |
| 900 Tornado 3 | 00 - 02 | 2 | 2539 | C59 | 2249 | RX3 |
| 900 Tornado Tre | 03 - | 2 | 1033 | C59 | 2827 | RX3 |
| 900 Tornado Tre RS (Rad. cali) | 04 - | 2 | 1033 | C59 | 2827 | RX3 |
| TNT 1100 | 04 - | 2 | 2539 | C59 | 2249 | RX3 |
| TNT 1130 | 05 - | 2 | 2539 | C59 | 2827 | RX3 |
| TNT 1130 Café Racer | 05 - | 2 | 1033 | C59 | 2827 | RX3 |
| TNT 1130 Sport / Titanium | 05 - | 2 | 1033 | C59 | 2827 | RX3 |
| TNT 1130 Officine | 07 - | 2 | 1033 | C59 | 2827 | RX3 |
| TNT 1130 Tornado Tre | 08 - | 2 | 1033 | C59 | 2827 | RX3 |
| Tre-K 1130 | 06 - | 2 | 2539 | C59 | 2827 | RX3 |
| Tre-K 1130 Amazonas | 07 - | 2 | 2539 | C59 | 2827 | RX3 |

BERINGER

| | | | | |
|--------------------------------|---|------|-----|--|
| 4 Piston Caliper - Road/Racing | 1 | 2251 | C59 | |
| 6 Piston Caliper - Road/Racing | 1 | 2404 | C59 | |

BILLET

| | | | | |
|--------------------------------|---|------|-----|--|
| 6 Piston Caliper - Road/Racing | 3 | 2249 | C59 | |
|--------------------------------|---|------|-----|--|

BIMOTA

| | | | | | | |
|------------------------|---------|---|------|-----|------|-----|
| YB9 600 SRI | 96 - | 2 | 2247 | C59 | 2249 | RX3 |
| SB7 750 | 96 - | 2 | 2247 | C59 | 2249 | RX3 |
| YB4 750 | 89 | 2 | 2247 | C59 | 2249 | RX3 |
| 1D 851 Tesi | 91 - 95 | 2 | 2247 | C59 | 2249 | RX3 |
| DB2 900 | 92 - | 2 | 2247 | C59 | 2249 | RX3 |
| DB4 900 | 99 - | 2 | 2539 | C59 | 2249 | RX3 |
| 900 Mantra | 96 - | 2 | 2247 | C59 | 2249 | RX3 |
| 1D 904 Tesi SR / ES | 96 - | 2 | 2247 | C59 | 2249 | RX3 |
| DB2 904 HF / SR | 96 - | 2 | 2247 | C59 | 2249 | RX3 |
| 1D 906 Tesi | 91 - 95 | 2 | 2247 | C59 | 2249 | RX3 |
| 2D 1000 Tesi | 04 - 06 | 2 | 2247 | C59 | 2249 | RX3 |
| DB5 1000 R | 07 - | 2 | 1033 | C59 | 2827 | RX3 |
| DB5 1000 S | 07 - | 2 | 1033 | C59 | 2827 | RX3 |
| DB6 1000 Delirio | 07 - | 2 | 1033 | C59 | 2827 | RX3 |
| SB8 1000 R | 98 - | 2 | 2539 | C59 | 2249 | RX3 |
| YB6 1000 | 89 | 2 | 2247 | C59 | 2249 | RX3 |
| YB8 1000 | 90 - 95 | 2 | 2247 | C59 | 2249 | RX3 |
| YB11 1000 | 97 - | 2 | 2247 | C59 | 2249 | RX3 |
| YB11 1002 Dieci | 91 - 95 | 2 | 2247 | C59 | 2249 | RX3 |
| YB11 1002 Superleggera | 96 | 2 | 2247 | C59 | 2249 | RX3 |
| DB7 1098 (Rad. Cal) | 08 - | 2 | 1033 | C59 | 2827 | RX3 |
| DB7 1099 (Rad. Cal) | 09 - | 2 | 1185 | C59 | 2249 | RX3 |
| DB6R 1100 Delirio | 08 - | 2 | 1033 | C59 | 2827 | RX3 |
| SB6 1100 R | 97 - | 2 | 2247 | C59 | 2249 | RX3 |
| 3D 1100 Tesi | 07 - | 2 | 1033 | C59 | 2827 | RX3 |
| SB6 1100 | 96 - | 2 | 2247 | C59 | 2249 | RX3 |
| 1D Tesi | 93 - | 2 | 2247 | C59 | 2249 | RX3 |
| DB2 | 92 - | 2 | 2247 | C59 | 2249 | RX3 |
| All models | 89 - 98 | 2 | 2247 | C59 | 2249 | RX3 |
| Furano | 92 - | 2 | 2247 | C59 | 2249 | RX3 |

BMW

| | | | | | | |
|-----------|------|---|------|-----|------|-----|
| S 1000 RR | 09 - | 2 | 1207 | C59 | 2353 | RX3 |
|-----------|------|---|------|-----|------|-----|

BREMBO

| | | | | |
|---------------------------------------|---|------|-----|--|
| 4 Piston Caliper - Racing | 1 | 2933 | C59 | |
| P32x36 Monobloc Caliper - Racing | 1 | 2329 | C59 | |
| P4 30x30 Double pin - Road/Racing | 1 | 2539 | C59 | |
| P4 34x30 Single pin - Road/Racing | 1 | 2247 | C59 | |
| P4 34x34 Gold - Road/Racing | 1 | 1033 | C59 | |
| P4 34x34 Radial Caliper - Road/Racing | 1 | 1033 | C59 | |
| P4 Radial 2 Pieces Caliper - Racing | 1 | 2329 | C59 | |
| P4 Radial Monobloc Caliper - Racing | 1 | 2329 | C59 | |

CAGIVA

| | | | | | | |
|-------------|------|---|------|-----|------|-----|
| 500 Mito | 07 | 1 | 2247 | C59 | 2249 | RX3 |
| SP 525 Mito | 08 - | 1 | 2247 | C59 | 2249 | RX3 |

DUCATI

| | | | | | | |
|---------------------------|---------|---|------|-----|------|-----|
| 748 / S | 99 - 03 | 2 | 2539 | C59 | 2249 | RX3 |
| 748 Biposto / SP / Strada | 95 - 99 | 2 | 2247 | C59 | 2249 | RX3 |
| 748 R | 00 | 2 | 2539 | C59 | 2249 | RX3 |
| 748 R | 01 - 03 | 2 | 1033 | C59 | 2249 | RX3 |
| 748 SPS | 98 - 99 | 2 | 2539 | C59 | 2249 | RX3 |
| 749 / S | 03 - | 2 | 1033 | C59 | 2827 | RX3 |
| 749 R / Dark | 04 - | 2 | 1033 | C59 | 2827 | RX3 |
| 796 Hypermotard | 10 - | 2 | 2539 | C59 | 2827 | RX3 |
| 848 | 08 - | 2 | 2539 | C59 | 2827 | RX3 |
| 916 Biposto | 95 - 97 | 2 | 2247 | C59 | 2249 | RX3 |
| 916 SP / Strada / Senna | 94 - 97 | 2 | 2247 | C59 | 2249 | RX3 |
| 916 SPS | 97 - 98 | 2 | 2539 | C59 | 2249 | RX3 |
| 996 R | 01 | 2 | 1033 | C59 | 2249 | RX3 |
| 996 SPS | 99 - 01 | 2 | 2539 | C59 | 2249 | RX3 |
| 998 / S | 02 - 03 | 2 | 2539 | C59 | 2249 | RX3 |
| 998 R | 02 | 2 | 1033 | C59 | 2249 | RX3 |
| 999 / S / R | 03 - | 2 | 1033 | C59 | 2827 | RX3 |
| 999 RS | 04 - | 2 | 1033 | C59 | 2984 | RX3 |
| 999 R Xerox | 06 - | 2 | 1033 | C59 | 2827 | RX3 |
| 1098 / S | 07 - 08 | 2 | 1185 | C59 | 2827 | RX3 |
| 1098 R | 08 | 2 | 1185 | C59 | 2827 | RX3 |
| 1098 R Bayliss LE | 09 | 2 | 1185 | C59 | 2827 | RX3 |
| 1098 S | 07 - 08 | 2 | 1185 | C59 | 2827 | RX3 |
| 1100 Hypermotard | 07 - | 2 | 2539 | C59 | 2827 | RX3 |
| 1100 Hypermotard Evo / SP | 10 - | 2 | 1185 | C59 | 2827 | RX3 |
| 1198 / S | 09 - | 2 | 1185 | C59 | 2827 | RX3 |

HONDA

| | | | | | | |
|---------------------------------|---------|---|------|-----|------|-----|
| RS 125 R | 91 - 94 | 1 | 2256 | C59 | 2287 | RX3 |
| RS 125 R | 95 - | 1 | 1157 | C59 | 2287 | RX3 |
| RS 250 R | 91 - 92 | 2 | 2245 | C59 | 2298 | RX3 |
| RS 250 R | 93 - | 2 | 1157 | C59 | 2287 | RX3 |
| CBR 600 F Hurricane | 87 - 90 | 2 | 2252 | C59 | 2289 | RX3 |
| CBR 600 F / F Supersport | 91 - 94 | 2 | 2252 | C59 | 2296 | RX3 |
| CBR 600 F3 | 95 - 98 | 2 | 2256 | C59 | 2296 | RX3 |
| CBR 600 F 4 / F 4 Sport | 99 - 00 | 2 | 2711 | C59 | 2296 | RX3 |
| CBR 600 F/FS | 01 - | 2 | 2711 | C59 | 2296 | RX3 |
| CBR 600 RR | 03 - 04 | 2 | 2711 | C59 | 2296 | RX3 |
| CBR 600 RR (Rad.cal) | 05 - 06 | 2 | 1134 | C59 | 2296 | RX3 |
| CBR 600 RR (Rad.cal) | 07 - | 2 | 1134 | C59 | 1174 | RX3 |
| CBR 600 RR (Rad.cal) - ABS | 09 - | 2 | 1134 | C59 | 1174 | RX3 |
| CBR 900 RR Fireblade | 92 - 97 | 2 | 2245 | C59 | 2296 | RX3 |
| CBR 900 RR Fireblade | 98 - 99 | 2 | 2711 | C59 | 2296 | RX3 |
| CBR 900 RR Fireblade (929) | 00 - 01 | 2 | 2711 | C59 | 2296 | RX3 |
| CBR 900 RR Fireblade (954) | 02 - 03 | 2 | 2711 | C59 | 2296 | RX3 |
| CBR 1000 RR Fireblade | 04 - 05 | 2 | 1134 | C59 | 2296 | RX3 |
| CBR 1000 RR Fireblade (Rad.cal) | 06 - 08 | 2 | 1134 | C59 | 1174 | RX3 |
| CBR 1000 RR Fireblade (Rad.cal) | 09 - | 2 | 1134 | C59 | 1174 | RX3 |
| VTR 1000 SP-1 | 00 - 01 | 2 | 2711 | C59 | 2296 | RX3 |
| VTR 1000 SP-2 | 02 - 07 | 2 | 2711 | C59 | 2296 | RX3 |

HUSQVARNA

| | | | | | | |
|---------------|---------|---|------|-----|------|-----|
| SM 450 R | 05 | 1 | 1033 | C59 | 2353 | RX3 |
| SM 450 R / RR | 06 - 08 | 1 | 1033 | C59 | 1108 | RX3 |
| SM 450 R / RR | 09 - | 1 | 1033 | C59 | 1108 | RX3 |
| SM 510 R | 06 | 1 | 1033 | C59 | 1108 | RX3 |
| SM 510 R | 05 | 1 | 2247 | C59 | 2353 | RX3 |
| SM 570 R | 06 | 1 | 2247 | C59 | 1108 | RX3 |
| SM 630 | 10 - | 1 | 1033 | C59 | 1108 | RX3 |
| SMR 630 | 04 - 05 | 1 | 2247 | C59 | 2353 | RX3 |
| SMR 630 | 06 | 1 | 2247 | C59 | 1108 | RX3 |



ISR

| | | | | | | |
|-------------------------------------------------|--|---|------|-----|--|--|
| 2 Piston Caliper (22-027/028/029) - Road/Racing | | 2 | 2249 | C59 | | |
|-------------------------------------------------|--|---|------|-----|--|--|

KAWASAKI

| | | | | | | | | |
|--------|------|-----------------|---------|-----|------|-----|------|-----|
| ZX6-R | 600 | D1-D4 | 90 - 93 | 2 | 2251 | C59 | 2304 | RX3 |
| ZX6-R | 600 | E1-E5 Ninja | 93 - 97 | 2 | 2251 | C59 | 2381 | RX3 |
| ZX6-R | 600 | Ninja F1 / F2 | 95 - 97 | 2 | 2251 | C59 | 2381 | RX3 |
| ZX6-R | 600 | Ninja (ZX600G) | 98 - 02 | 2 | 2255 | C59 | 2381 | RX3 |
| ZX6-R | 636 | Ninja | 02 | 2 | 2255 | C59 | 2381 | RX3 |
| ZX6-RR | 600 | Ninja (Rad.Cal) | 03 - 06 | 2 | 1110 | C59 | 2381 | RX3 |
| ZX6-R | 636 | Ninja (Rad.Cal) | 03 - 06 | 2 | 1110 | C59 | 2381 | RX3 |
| ZX6-R | 600 | Ninja (Rad.Cal) | 07 - | 2 | 1177 | C59 | 2381 | RX3 |
| ER-6 | 650 | F | 06 - | 1 L | 2383 | C59 | 2381 | RX3 |
| ER-6 | 650 | F | 06 - | 1 R | 2384 | C59 | | |
| ER-6 | 650 | | 06 - | 1 L | 2383 | C59 | 2381 | RX3 |
| ER-6 | 650 | | 06 - | 1 R | 2384 | C59 | | |
| ZX7-R | 750 | Ninja | 89 - 95 | 2 | 2251 | C59 | 2282 | RX3 |
| ZX7-R | 750 | Ninja | 96 - 02 | 2 | 2255 | C59 | 2282 | RX3 |
| ZX7-RR | 750 | Ninja | 96 - 02 | 2 | 2899 | C59 | 2813 | RX3 |
| ZXR | 750 | R | 89 - 92 | 2 | 2251 | C59 | 2282 | RX3 |
| ZXR | 750 | R | 93 - 95 | 2 | 2251 | C59 | 2282 | RX3 |
| ZX9-R | 900 | Ninja | 94 - 95 | 2 | 2251 | C59 | 2381 | RX3 |
| ZX9-R | 900 | Ninja / C Ninja | 96 - 01 | 2 | 2255 | C59 | 2381 | RX3 |
| ZX9-R | 900 | Ninja | 02 - 03 | 2 | 1083 | C59 | 2381 | RX3 |
| ZX10-R | 1000 | Ninja (Rad.Cal) | 04 - 07 | 2 | 1110 | C59 | 2381 | RX3 |
| ZX10-R | 1000 | Ninja (Rad.Cal) | 08 - 10 | 2 | 1133 | C59 | 2381 | RX3 |
| ZX10-R | 1000 | Ninja (Rad.Cal) | 11 - | 2 | 1133 | C59 | 2381 | RX3 |

KTM

| | | | | | | | |
|------|---------------|---------|---|------|-----|------|-----|
| 690 | Duke R | 10 - | 1 | 1033 | C59 | 2353 | RX3 |
| 690 | SMC | 08 - 10 | 1 | 1033 | C59 | 2353 | RX3 |
| 690 | SMR | 07 - 09 | 1 | 1033 | C59 | 2353 | RX3 |
| 950 | SMR | 07 | 1 | 1033 | C59 | 2352 | RX3 |
| 990 | Super Duke R | 09 - | 2 | 1033 | C59 | 2353 | RX3 |
| 990 | Supermoto / R | 07 - | 2 | 1033 | C59 | 2352 | RX3 |
| 990 | Super moto T | 09 - | 2 | 1033 | C59 | 2352 | RX3 |
| RC-8 | 1190 | 08 - | 2 | 1185 | C59 | 2827 | RX3 |
| RC8 | 1190 R | 09 - | 2 | 1185 | C59 | 2827 | RX3 |

MV AGUSTA

| | | | | | | | |
|------|-------------------------------|---------|---|------|-----|------|-----|
| 750 | Brutale (All Models) (Nissin) | 03 - 08 | 2 | 2899 | C59 | 1203 | RX3 |
| 750 | F4 (All Models) (Nissin) | 99 - 03 | 2 | 2899 | C59 | 1203 | RX3 |
| 910 | Brutale S (Nissin) | 05 - 08 | 2 | 2899 | C59 | 1203 | RX3 |
| 910 | Brutale R (Brembo) | 05 - 08 | 2 | 1033 | C59 | 1203 | RX3 |
| 989 | Brutale R | 08 - 09 | 2 | 2539 | C59 | 1203 | RX3 |
| 920 | Brutale | 11 - | 2 | 2539 | C59 | 1203 | RX3 |
| 990 | Brutale R | 10 - | 2 | 2539 | C59 | 1203 | RX3 |
| 998 | F4 | 10 - | 2 | 1185 | C59 | 1203 | RX3 |
| 1000 | F4 (All Models) (Nissin) | 04 - 06 | 2 | 2899 | C59 | 1203 | RX3 |
| 1000 | F4 Senna | 06 | 2 | 1033 | C59 | 1203 | RX3 |
| 1000 | F4 R (Brembo) | 06 - 07 | 2 | 1033 | C59 | 1203 | RX3 |
| 1000 | F4 RR 312 (Brembo) | 07 | 2 | 1033 | C59 | 1203 | RX3 |
| 1078 | Brutale RR | 08 - 09 | 2 | 1185 | C59 | 1203 | RX3 |
| 1078 | F4 RR 312 (Brembo) | 08 - | 2 | 1185 | C59 | 1203 | RX3 |
| 1090 | Brutale RR | 10 - | 2 | 1185 | C59 | 1203 | RX3 |

NISSIN

| | | | | | | |
|---------------------------------------|--|---|------|-----|--|--|
| 4 Piston Caliper - Road/Racing | | 1 | 2246 | C59 | | |
| 4 Piston Radial Caliper - Road/Racing | | 1 | 1083 | C59 | | |
| 6 Piston Caliper - Road/Racing | | 1 | 2404 | C59 | | |
| 6 Piston Caliper - Road/Racing | | 1 | 2899 | C59 | | |
| 6 Piston Radial Caliper - Endurance | | 1 | 2931 | C59 | | |

PVM

| | | | | | | |
|---------------------------|--|---|------|-----|--|--|
| 4 Piston Caliper - Racing | | 1 | 2933 | C59 | | |
| 6 Piston Caliper - Racing | | 1 | 2584 | C59 | | |
| Radial Caliper - Racing | | 2 | 1075 | C59 | | |

SPIEGLER

| | | | | | | |
|--------------------------------|--|---|------|-----|--|--|
| 4 Piston Caliper - Road/Racing | | 1 | 2920 | C59 | | |
| 8 Piston Caliper - Road/Racing | | 1 | 2586 | C59 | | |
| 8 Piston Caliper - Road/Racing | | 1 | 2919 | C59 | | |

SUZUKI

| | | | | | | | | |
|-------|-----|------------------------|---------|---|------|-----|------|-----|
| GSX-R | 600 | | 93 - 96 | 2 | 2246 | C59 | 2282 | RX3 |
| GSX-R | 600 | V/W/X/Y/K1/K2/K3 | 97 - 03 | 2 | 2251 | C59 | 2282 | RX3 |
| GSX-R | 600 | K4 / K5 (Rad.cal) | 04 - 05 | 2 | 1133 | C59 | 2813 | RX3 |
| GSX-R | 600 | K6 / K7 (Rad.cal) | 06 - 07 | 2 | 1133 | C59 | 1163 | RX3 |
| GSX-R | 600 | K8 / K9 / L0 (Rad.cal) | 08 - | 2 | 1133 | C59 | 1163 | RX3 |

SUZUKI

| | | | | | | | | |
|-------|------|-------------------------|---------|---|------|-----|------|-----|
| GSX-R | 600 | Brembo (Rad.cal) | 11 - | 2 | 1185 | C59 | 1174 | RX3 |
| GSX-R | 750 | RG | 86 | 2 | 2246 | C59 | 2282 | RX3 |
| GSX-R | 750 | J / K / L / M / WN / WP | 88 - 93 | 2 | 2246 | C59 | 2282 | RX3 |
| GSX-R | 750 | WR / WS | 94 - 95 | 2 | 2255 | C59 | 2282 | RX3 |
| GSX-R | 750 | T / V / W / X | 96 - 99 | 2 | 2255 | C59 | 2282 | RX3 |
| GSX-R | 750 | Y / K1 / K2 / K3 | 00 - 03 | 2 | 2251 | C59 | 2282 | RX3 |
| GSX-R | 750 | K4 / K5 (Rad.cal) | 04 - 05 | 2 | 1133 | C59 | 2813 | RX3 |
| GSX-R | 750 | K6 / K7 (Rad.cal) | 06 - 07 | 2 | 1133 | C59 | 1163 | RX3 |
| GSX-R | 750 | K8 / K9 / L0 (Rad.cal) | 08 - | 2 | 1133 | C59 | 1163 | RX3 |
| GSX-R | 750 | Brembo (Rad.cal) | 11 - | 2 | 1185 | C59 | 1174 | RX3 |
| GSX-R | 1000 | K1 / K2 | 01 - 02 | 2 | 2255 | C59 | 2813 | RX3 |
| GSX-R | 1000 | K3 (Rad.cal) | 03 | 2 | 1110 | C59 | 2813 | RX3 |
| GSX-R | 1000 | K4 (Rad.cal) | 04 | 2 | 1133 | C59 | 2813 | RX3 |
| GSX-R | 1000 | K5 / K6 (Rad.cal) | 05 - 06 | 2 | 1133 | C59 | 2813 | RX3 |
| GSX-R | 1000 | K7 / K8 (Rad.cal) | 07 - 08 | 2 | 1133 | C59 | 1163 | RX3 |
| GSX-R | 1000 | K9 / L0 (Rad.cal) | 09 - | 2 | 1133 | C59 | 1174 | RX3 |
| SV | 1000 | S / N K3 -K7 | 03 - 07 | 2 | 2251 | C59 | 2296 | RX3 |
| TL | 1000 | S | 97 - 01 | 2 | 2251 | C59 | 2282 | RX3 |
| TL | 1000 | R | 98 - 02 | 2 | 2255 | C59 | 2282 | RX3 |

TRIUMPH

| | | | | | | | |
|------|-------------------------------|---------|---|------|-----|------|-----|
| 675 | Daytona (Rad.cal) | 06 - 08 | 2 | 1083 | C59 | 2298 | RX3 |
| 675 | Daytona (Rad.cal) | 09 - | 2 | 1209 | C59 | 2298 | RX3 |
| 1050 | Speed Triple (Nissin Rad.Cal) | 05 - 07 | 2 | 1083 | C59 | 2288 | RX3 |
| 1050 | Speed Triple (Brembo Rad.Cal) | 08 - | 2 | 1033 | C59 | 2288 | RX3 |

YAMAHA

| | | | | | | | | |
|-----|------|----------------------|---------|---|------|-----|------|-----|
| YZF | 600 | R6 | 99 - 02 | 2 | 2361 | C59 | 2828 | RX3 |
| YZF | 600 | R6 | 03 - 05 | 2 | 2361 | C59 | 2296 | RX3 |
| YZF | 600 | R6 | 06 - 09 | 2 | 2361 | C59 | 2296 | RX3 |
| YZF | 600 | R6 | 10 - | 2 | 2361 | C59 | 2296 | RX3 |
| FZR | 750 | R (OW01) | 89 - 90 | 2 | 2246 | C59 | 2283 | RX3 |
| YZF | 750 | R7 (OW02) | 99 - 01 | 2 | 2361 | C59 | 2713 | RX3 |
| YZF | 750 | R7 (OW02) "Race Kit" | 99 - 01 | 2 | 2899 | C59 | NA | |
| TRX | 850 | | 96 - 99 | 2 | 2305 | C59 | 2283 | RX3 |
| YZF | 1000 | R1 | 98 - 01 | 2 | 2361 | C59 | 2713 | RX3 |
| YZF | 1000 | R1 | 02 - 03 | 2 | 2361 | C59 | 2828 | RX3 |
| YZF | 1000 | R1 / R1 SP | 04 - 06 | 2 | 2361 | C59 | 2296 | RX3 |
| YZF | 1000 | R1 (Rad.cal) | 07 - 08 | 2 | 1180 | C59 | 2296 | RX3 |
| YZF | 1000 | R1 (Rad.cal) | 09 - | 2 | 1180 | C59 | 2296 | RX3 |



Tout-Terrain / Off-Road / Fuoristrada / Todo Terreno



Tout-Terrain

Off-Road



ALFER

| | | | | | | |
|-------------------|--|------|------|------|------|-----|
| MC 80 | | 87 - | 2249 | MX10 | 2377 | X59 |
| MC 125 | | 88 | 2398 | MX10 | 2249 | X59 |
| 125 Enduro | | 97 - | 2288 | EN10 | 2299 | X59 |
| MC 125 | | 87 | 2249 | MX10 | T | |
| VRE 125 | | 00 - | 2352 | EN10 | 2353 | X59 |
| MC 250 | | 85 | 2249 | MX10 | T | |
| MC 250 | | 87 | 2249 | MX10 | 2249 | X59 |
| MC 250 | | 88 | 2398 | MX10 | 2249 | X59 |
| VR 250 All Models | | 99 - | 2352 | EN10 | 2353 | X59 |
| GR 250 Enduro | | 85 | 2249 | EN10 | T | |
| 250 Enduro | | 97 - | 2288 | EN10 | 2299 | X59 |
| GR 250 Enduro | | 88 | 2398 | EN10 | 2249 | X59 |
| GR 300 Enduro | | 88 | 2398 | EN10 | 2249 | X59 |
| GR 300 | | 85 | 2249 | EN10 | T | |

AJP

| | | | | | | |
|----------------|--|------|------|------|------|-----|
| MX 200 | | 09 - | 1146 | MX10 | 2377 | X59 |
| PR5 250 Enduro | | 09 - | 2300 | EN10 | 2314 | X59 |
| PR3 125 Enduro | | 08 - | 1146 | EN10 | NA | |
| PR4 125 Enduro | | 04 - | NA | | NA | |
| PR3 200 Enduro | | 08 - | 1146 | EN10 | NA | |
| PR4 200 Enduro | | 04 - | NA | | NA | |

APRILIA

| | | | | | | |
|-----------------|--|---------|------|------|------|-----|
| RX 125 | | 90 - 96 | 2400 | EN10 | 2306 | X59 |
| RX 125 | | 97 - | 2352 | EN10 | 2306 | X59 |
| 200 Climber | | 93 | 2249 | EN10 | 2249 | X59 |
| 240 Climber | | 89 - 90 | 2260 | EN10 | 1089 | X59 |
| TX 240 | | 86 - | 2377 | EN10 | T | |
| MX 250 Cross | | 85 | 2249 | MX10 | T | |
| RX 250 | | 86 - | 2249 | EN10 | T | |
| 275 Climber | | 89 - 90 | 2260 | EN10 | 1089 | X59 |
| 280 Climber / R | | 92 | 2377 | EN10 | 2377 | X59 |
| TX 311 | | 86 | 2377 | EN10 | T | |
| TX 312 M | | 88 | 2377 | EN10 | 2377 | X59 |
| TXR 312 M | | 88 | 2377 | EN10 | 2377 | X59 |
| MXV 450 | | 09 - | 2300 | MX10 | 1076 | X59 |
| RXV 450 Enduro | | 06 - | 2300 | EN10 | 1103 | X59 |
| RXV 550 Enduro | | 06 - | 2300 | EN10 | 1103 | X59 |

ARMSTRONG

| | | | | | | |
|--------|--|------|------|------|---|--|
| MX 500 | | 86 - | 2249 | MX10 | T | |
| MX 600 | | 86 - | 2249 | MX10 | T | |

ATK

| | | | | | | |
|----------------------------|--|---------|------|------|------|-----|
| ATK 250 CC / MX | | 91 - 92 | 2398 | MX10 | 2249 | X59 |
| ATK 350 ES / CC / MX / STD | | 91 - 92 | 2398 | MX10 | 2249 | X59 |
| ATK 350 GS | | 93 - | 2249 | MX10 | 2249 | X59 |
| ATK 406 CC / MX | | 91 - 92 | 2398 | MX10 | 2249 | X59 |
| ATK 560 | | 86 | 2249 | MX10 | T | |
| ATK 560 | | 84 - 85 | 2249 | MX10 | T | |
| ATK 560 | | 87 - 88 | 2249 | MX10 | 2377 | X59 |
| ATK 560 | | 89 - 91 | 2398 | MX10 | 2260 | X59 |
| ATK 604 ES / CC / MX / STD | | 91 - 92 | 2398 | MX10 | 2249 | X59 |
| ATK 604 Quadracer | | 90 - | 2398 | MX10 | 2260 | X59 |
| ATK 604 | | 91 - | 2398 | MX10 | 2260 | X59 |
| ATK 640 | | 93 - | 2249 | MX10 | 2249 | X59 |
| ATK All models | | 94 | 2288 | MX10 | 2288 | X59 |

BENELLI

| | | | | | | |
|--------------|--|------|------|------|------|-----|
| BX 449 Cross | | 07 - | 2352 | MX10 | 2353 | X59 |
| 505 Enduro | | 08 - | 2352 | MX10 | 2353 | X59 |

BETA

| | | | | | | |
|------------------|--|---------|------|------|------|-----|
| MX 50 Enduro | | 92 | 2260 | EN10 | | |
| 50 Rev | | 00 - | 2377 | EN10 | 2377 | X59 |
| 50 Super Trial | | 92 | 2377 | EN10 | | |
| KR 50 Twin | | 88 | 2249 | EN10 | 2249 | X59 |
| ALP 50 | | 91 - | NA | | 2260 | X59 |
| KR 50 | | 86 - 87 | 2249 | EN10 | | |
| ST 50 | | 97 - | 2377 | EN10 | 2377 | X59 |
| 80 Rev | | 00 - | 2377 | EN10 | 2377 | X59 |
| 80 Evo Junior | | 10 - | 2377 | EN10 | 2377 | X59 |
| TR 125 34 | | 88 | 2377 | EN10 | 2260 | X59 |
| TR 125 34 / 35 | | 89 - 90 | 2377 | EN10 | 2377 | X59 |
| ALP 125 4 Stroke | | 00 - 05 | 2377 | EN10 | 2377 | X59 |
| ALP 125 4 Stroke | | 06 - | 1146 | EN10 | NA | |
| RR 125 Enduro | | 06 - | 1146 | EN10 | NA | |
| TRIAL 125 | | 97 - | 2377 | EN10 | NA | |

BETA

| | | | | | | |
|-----------------------|--|---------|------|------|------|-----|
| ALP 200 4 Stroke | | 00 - 05 | 2377 | EN10 | 2377 | X59 |
| ALP 200 4 Stroke | | 06 - | 1146 | EN10 | NA | |
| ALP 240 | | 96 - | 2377 | EN10 | 2249 | X59 |
| 240 Super Trial | | 92 - | 2377 | EN10 | | |
| ALP 240 | | 92 | 2377 | EN10 | | |
| RR 250 Enduro | | 05 - | 2300 | EN10 | 1103 | X59 |
| 250 Techno | | 96 - 98 | 2377 | EN10 | 2377 | X59 |
| 250 Techno | | 99 - | 2377 | EN10 | 2377 | X59 |
| 250 Zéro | | 91 - | 2377 | EN10 | NA | |
| ALP 250 | | 92 | 2377 | EN10 | NA | |
| ALP 250 | | 97 - | 2377 | EN10 | 2377 | X59 |
| CR 250 | | 83 - | 2249 | MX10 | | |
| TR 260 34 | | 86 - 88 | NA | | 2260 | X59 |
| ALP 260 | | 96 - | 2377 | EN10 | 2249 | X59 |
| 260 Zéro | | 91 - | 2377 | EN10 | | |
| TR 260 Zéro / 34 / 35 | | 89 - 92 | 2377 | EN10 | NA | |
| ALP 350 4.0 | | 04 - 05 | 1146 | EN10 | 1089 | X59 |
| ALP 350 4.0 | | 06 - | 1146 | EN10 | NA | |
| RR 400 Enduro | | 05 - | 2300 | EN10 | 1103 | X59 |
| RR 450 Enduro | | 05 - | 2300 | EN10 | 1103 | X59 |
| 500 GS / RV | | 84 - | 2249 | EN10 | | |
| RR 525 Enduro | | 05 - | 2300 | EN10 | 1103 | X59 |
| SR 34 | | 89 | 2377 | EN10 | | |
| TR 34 | | 92 - | 2601 | MX10 | | |
| TR 36 | | 92 - | 2601 | MX10 | | |

BMW

| | | | | | | |
|--------------|--|------|------|------|------|-----|
| G 450 Enduro | | 08 - | 2352 | EN10 | 1108 | X59 |
|--------------|--|------|------|------|------|-----|

CAGIVA

| | | | | | | |
|--------------------|--|---------|------|------|------|-----|
| 125 Cross | | 86 - | 2400 | MX10 | 2306 | X59 |
| 125 Enduro | | 86 - | 2249 | EN10 | T | |
| W8 125 / R | | 94 - | 2400 | EN10 | 1089 | X59 |
| WMX 125 GP Replica | | 86 - | 2249 | MX10 | T | |
| WMX 125 | | 89 - 90 | 2400 | MX10 | 2306 | X59 |
| WMX 125 | | 88 | 2400 | MX10 | T | |
| WRX 125 | | 83 | 2249 | MX10 | T | |
| 250 Cross | | 86 - | 2400 | MX10 | T | |
| WMX 250 GP | | 82 | 2249 | MX10 | T | |
| MXR 250 | | 82 - | 2249 | MX10 | T | |
| WMX 250 | | 89 - 90 | 2400 | MX10 | 2306 | X59 |
| WMX 250 | | 88 - | 2400 | MX10 | T | |
| WMX 500 Cross | | 87 | 2249 | MX10 | 2249 | X59 |
| WMX 500 | | 85 - 86 | 2249 | MX10 | T | |

CANNONDALE

| | | | | | | |
|---------------|--|------|------|------|------|-----|
| MX 400 | | 00 - | 2300 | MX10 | 2299 | X59 |
| 440 C / E / X | | 03 - | 2300 | MX10 | 2299 | X59 |

CCM

| | | | | | | |
|--------|--|------|------|------|------|-----|
| MX 450 | | 08 - | 2352 | MX10 | 2353 | X59 |
|--------|--|------|------|------|------|-----|

DB MOTORS

| | | | | | | |
|-------------|--|------|------|------|------|-----|
| ZZ 50 Pirat | | 00 - | 2249 | MX10 | 2249 | X59 |
| 50 Sport | | 00 - | 2249 | MX10 | 2249 | X59 |

DERBI

| | | | | | | |
|----------------|--|------|------|------|------|-----|
| 125 Senda R 4T | | 04 - | 1146 | EN10 | 2377 | X59 |
|----------------|--|------|------|------|------|-----|

FACTORY

| | | | | | | |
|---------------------|--|------|------|------|------|-----|
| R12 50 Phantom Agua | | 06 - | NA | | 2377 | X59 |
| R14 50 Phantom Agua | | 04 - | NA | | 2377 | X59 |
| R14 50 Phantom Aire | | 03 - | 2377 | MX10 | | |
| YR 125 | | 06 - | NA | | 2377 | X59 |
| YR 250 | | 99 - | 2352 | MX10 | 2353 | X59 |

FANTIC

| | | | | | | |
|------------------------------|--|------|------|------|------|-----|
| MX 50 Regolarna Competizione | | 08 - | 2300 | EN10 | 2314 | X59 |
| XM 50 Caballero | | 98 - | 2249 | EN10 | 2249 | X59 |
| RS 50 Caballero | | 91 - | 2249 | EN10 | 2249 | X59 |
| RC 50 Caballero | | 91 - | 2249 | EN10 | 2249 | X59 |
| 50 Clubman | | | 2377 | EN10 | 2377 | X59 |
| 50 Oasis | | 90 - | 2260 | EN10 | 1089 | X59 |
| 50 Regolarna Competizione | | 08 - | 2300 | EN10 | 2314 | X59 |
| 50 Trial .5 .7 .9 | | 89 - | 2377 | EN10 | 2377 | X59 |
| MX 65 Regolarna Competizione | | 08 - | 2300 | EN10 | 2314 | X59 |
| 75 Oasis | | 89 - | 2260 | EN10 | 1089 | X59 |
| 80 Clubman | | | 2377 | EN10 | 2377 | X59 |
| 80 Regolarna Competizione | | 08 - | 2300 | EN10 | 2314 | X59 |



FANTIC

| | | | | | | |
|-------|------------------------|------|------|------|------|-----|
| MX 85 | Regolarna Competizione | 08 - | 2300 | EN10 | 2314 | X59 |
| 125 | Clubman | | 2377 | EN10 | 2377 | X59 |
| 125 | Regolarna Competizione | 08 - | 2300 | EN10 | 2314 | X59 |
| 250 | C@sta | 98 - | 2377 | EN10 | 2377 | X59 |
| 250 | Clubman | | 2377 | EN10 | 2377 | X59 |
| 250 | Coach | 91 - | 2249 | EN10 | 2377 | X59 |
| 250 | K Roo | 93 - | 2377 | EN10 | 2377 | X59 |
| 250 | Section | 96 - | 2377 | EN10 | 2377 | X59 |
| 305 | Trial | 89 | 2377 | EN10 | 2377 | X59 |
| 307 | Trial | 91 - | 2377 | EN10 | 2377 | X59 |

GAS GAS

| | | | | | | |
|---------|------------------|---------|------|------|------|-----|
| TXT 50 | Boy | 04 - | 2377 | EN10 | 2377 | X59 |
| 125 | Enducross | 93 - 96 | 2352 | EN10 | 2353 | X59 |
| 125 | Delta | 91 - | 2377 | EN10 | | |
| 125 | Trial | 91 - | 2377 | EN10 | | |
| 125 | Pampera | 04 - | 1146 | EN10 | NA | |
| 125 | Pampera | 97 - 03 | 2377 | EN10 | 2377 | X59 |
| JT 125 | R | 96 | 2377 | EN10 | 2377 | X59 |
| JT 125 | X | 97 - | 2377 | EN10 | 2377 | X59 |
| EC 125 | | 00 - | 2300 | EN10 | 2314 | X59 |
| EC 125 | | 97 - 99 | 2352 | EN10 | 2353 | X59 |
| MC 125 | | 03 - | 2300 | MX10 | 2314 | X59 |
| JT 160 | R | 96 | 2377 | EN10 | 2377 | X59 |
| EC 200 | Hobby | 07 - | 2300 | EN10 | 2314 | X59 |
| EC 200 | | 00 - | 2300 | EN10 | 2314 | X59 |
| EC 200 | | 99 | 2352 | EN10 | 2353 | X59 |
| 200 | Pampera | 99 - | 2377 | EN10 | 2377 | X59 |
| TX 200 | | 97 - | 2377 | EN10 | 2377 | X59 |
| EC 250 | FSE | 02 - | 2300 | EN10 | 2314 | X59 |
| JT 250 | Contact | 93 - 94 | 2377 | EN10 | 2377 | X59 |
| 250 | Pampera | 03 - | 1146 | EN10 | NA | |
| 250 | Pampera | 96 - 02 | 2377 | EN10 | 2377 | X59 |
| JT 250 | R Tarres Replica | 96 | 2377 | EN10 | 2377 | X59 |
| JT 250 | X | 97 - | 2377 | EN10 | 2377 | X59 |
| EC 250 | | 00 - | 2300 | EN10 | 2314 | X59 |
| EC 250 | | 97 - 99 | 2352 | EN10 | 2353 | X59 |
| MC 250 | | 00 - | 2300 | MX10 | 2314 | X59 |
| MC 250 | | 97 - 99 | 2352 | MX10 | 2353 | X59 |
| TXT 250 | Trial | 89 - | 2377 | EN10 | 2377 | X59 |
| JT 270 | X | 97 - | 2377 | EN10 | 2377 | X59 |
| TX 270 | Contact | 97 - | 2377 | EN10 | 2377 | X59 |
| 280 | Pampera | 04 - | 1146 | EN10 | NA | |
| EC 300 | | 99 | 2352 | EN10 | 2353 | X59 |
| EC 300 | | 00 - 08 | 2300 | EN10 | 2314 | X59 |
| EC 300 | | 09 - | 2300 | EN10 | 1103 | X59 |
| JT 320 | X | 97 - | 2377 | EN10 | 2377 | X59 |
| TX 320 | Contact | 97 - | 2377 | EN10 | 2377 | X59 |
| 325 | Halley PXC | | 2377 | EN10 | 2377 | X59 |
| 327 | Trial | | 2377 | EN10 | 2377 | X59 |
| 327 | Contact | | 2377 | EN10 | 2377 | X59 |
| 370 | Pampera | 96 - | 2377 | EN10 | 2377 | X59 |
| JT 370 | R 37 | 96 | 2377 | EN10 | 2377 | X59 |
| EC 400 | fse | 02 - | 2300 | EN10 | 2314 | X59 |
| 400 | Pampera | 06 - | 2300 | EN10 | 2314 | X59 |
| EC 450 | fse | 03 - | 2300 | EN10 | 2314 | X59 |
| EC 450 | FSR | 07 - | 2300 | EN10 | 2314 | X59 |
| EC 500 | fse Enduro | 06 - | 2300 | EN10 | 2314 | X59 |
| EC 515 | FSR | 08 - | 2300 | EN10 | 2314 | X59 |

HIGHLAND

| | | | | | | |
|-----|----|------|------|------|------|-----|
| 450 | MX | 06 - | 2352 | MX10 | 2353 | X59 |
|-----|----|------|------|------|------|-----|

HM

| | | | | | | |
|---------|----------------|---------|------|------|------|-----|
| CRE 125 | R Enduro | 95 - 01 | 2300 | EN10 | 2314 | X59 |
| CRE 125 | Enduro | 02 - 07 | 2300 | EN10 | 1076 | X59 |
| CRE 125 | F / X | 09 | 1146 | EN10 | 2314 | X59 |
| CRF 230 | Enduro / Trial | 04 - | 2300 | EN10 | 1076 | X59 |
| CRE 250 | R Enduro | 02 - | 2300 | EN10 | 1076 | X59 |
| CRF 250 | F | 04 - | 2300 | EN10 | 1076 | X59 |
| CRE 450 | F | 02 | 2300 | EN10 | 1076 | X59 |
| CRE 450 | R Enduro | 02 - | 2300 | EN10 | 1076 | X59 |
| CRE 450 | F / X | 04 - | 2300 | EN10 | 1076 | X59 |
| CRF 450 | R Enduro | 04 - | 2300 | EN10 | 1076 | X59 |
| CRF 450 | R | 04 - | 2300 | EN10 | 1076 | X59 |
| CRE 490 | X | 07 | 2300 | EN10 | 1076 | X59 |

HONDA

| | | | | | | |
|-------|---|---------|------|------|---|--|
| CR 80 | R | 86 - 91 | 2328 | MX10 | T | |
|-------|---|---------|------|------|---|--|

HONDA

| | | | | | | |
|---------|--------------|---------|------|------|------|-----|
| CR 80 | R / RB | 92 - 02 | 2328 | MX10 | 2314 | X59 |
| CRM 80 | | 89 - | 2328 | MX10 | 2314 | X59 |
| CR 85 | R / R Expert | 03 - | 2328 | MX10 | 2314 | X59 |
| CR 125 | RE / RF | 84 - 85 | 2451 | MX10 | T | |
| CR 125 | RG | 86 | 2451 | MX10 | T | |
| CR 125 | RH / RJ / RK | 87 - 94 | 2302 | MX10 | 2314 | X59 |
| CR 125 | R | 95 - 01 | 2300 | MX10 | 2314 | X59 |
| CR 125 | R | 02 - | 2300 | MX10 | 1076 | X59 |
| CRE 125 | | 02 - | 2300 | EN10 | 1076 | X59 |
| CRF 230 | | 04 - | 2300 | MX10 | T | |
| CR 250 | RE / RF | 84 - 85 | 2451 | MX10 | T | |
| CR 250 | RG | 86 | 2451 | MX10 | T | |
| CR 250 | / R | 87 - 94 | 2302 | MX10 | 2314 | X59 |
| CR 250 | R | 95 - 01 | 2300 | MX10 | 2314 | X59 |
| CR 250 | R | 02 - | 2300 | MX10 | 1076 | X59 |
| CRE 250 | | 02 - 03 | 2300 | EN10 | 1076 | X59 |
| CRE 250 | F | 04 - | 2300 | EN10 | 1076 | X59 |
| CRF 250 | R Efi | 04 - | 2300 | MX10 | 1076 | X59 |
| CRF 250 | X | 04 - | 2300 | MX10 | 1076 | X59 |
| XR 250 | L | 91 - 92 | 2302 | MX10 | 2314 | X59 |
| XR 250 | L | 93 - 96 | 2300 | EN10 | 2314 | X59 |
| XR 250 | R | 84 - 87 | 2451 | MX10 | T | |
| XR 250 | R | 88 - 89 | 2302 | MX10 | T | |
| XR 250 | R | 90 - 95 | 2302 | MX10 | 2314 | X59 |
| XR 250 | R | 96 - 04 | 2300 | EN10 | 2314 | X59 |
| ATC 300 | X | 86 - | 2302 | MX10 | 2328 | X59 |
| XR 350 | R | 84 - 85 | 2451 | MX10 | T | |
| XR 400 | R | 96 - | 2300 | EN10 | 2314 | X59 |
| XR 440 | R | 00 - | 2300 | EN10 | 2314 | X59 |
| CRE 450 | F | 02 - | 2300 | EN10 | 1076 | X59 |
| CRF 450 | R | 02 - 08 | 2300 | MX10 | 1076 | X59 |
| CRF 450 | R Efi | 09 - | 2300 | MX10 | 1076 | X59 |
| CRF 450 | X | 05 - | 2300 | MX10 | 1076 | X59 |
| CR 500 | RE / RF / RG | 84 - 86 | 2451 | MX10 | T | |
| CR 500 | R | 87 - 94 | 2302 | MX10 | 2314 | X59 |
| CR 500 | R | 95 - 01 | 2300 | MX10 | 2314 | X59 |
| XR 500 | R Pro Link | 83 - 84 | 2451 | MX10 | T | |
| XR 500 | R | 86 - | 2451 | MX10 | T | |
| XR 600 | R | 83 - 87 | 2451 | MX10 | T | |
| XR 600 | R | 88 - 90 | 2302 | MX10 | T | |
| XR 600 | R | 91 - 92 | 2302 | MX10 | 2314 | X59 |
| XR 600 | R | 93 - 00 | 2300 | EN10 | 2314 | X59 |
| XR 650 | L | 93 - | 2300 | EN10 | 2314 | X59 |
| XR 650 | R | 00 - | 2300 | EN10 | 2314 | X59 |

HRD

| | | | | | | |
|-----|-----|----|------|------|------|-----|
| 125 | GSE | 96 | 2288 | EN10 | 2299 | X59 |
| 250 | GSE | 96 | 2288 | EN10 | 2299 | X59 |

HUSABERG

| | | | | | | |
|------------|--------|---------|------|------|------|-----|
| All models | | 89 - 92 | 2400 | EN10 | 2306 | X59 |
| All models | | 93 - | 2352 | MX10 | 2353 | X59 |
| 350 | | 91 - | 2400 | EN10 | 2306 | X59 |
| FC 400 | | 99 - 02 | 2352 | MX10 | 2353 | X59 |
| FE 400 | E | 99 - 03 | 2352 | MX10 | 2353 | X59 |
| FC 450 | | 03 - | 2352 | MX10 | 2353 | X59 |
| FE 450 | / E | 04 - 08 | 2352 | EN10 | 2353 | X59 |
| FE 450 | | 09 - | 2352 | EN10 | 1108 | X59 |
| FX 450 | E | 03 - | 2352 | MX10 | 2353 | X59 |
| FC 470 | / E | 01 - 02 | 2352 | MX10 | 2353 | X59 |
| FX 470 | / E | 01 - 02 | 2352 | MX10 | 2353 | X59 |
| 500 | Enduro | | 2400 | EN10 | 2306 | X59 |
| FC 501 | | 99 - 01 | 2352 | MX10 | 2353 | X59 |
| FE 501 | E | 99 - 04 | 2352 | EN10 | 2353 | X59 |
| FC 550 | | 01 - | 2352 | MX10 | 2353 | X59 |
| FE 550 | E | 04 - | 2352 | EN10 | 2353 | X59 |
| FE 570 | | 09 - | 2352 | EN10 | 1108 | X59 |
| FC 600 | | 94 - | 2352 | MX10 | 2353 | X59 |
| FC 600 | | 99 - 01 | 2352 | MX10 | 2353 | X59 |
| FE 600 | E | 99 - 02 | 2352 | EN10 | 2353 | X59 |
| FE 650 | E | 01 - | 2352 | EN10 | 2353 | X59 |
| FX 650 | E | 01 - | 2352 | MX10 | 2353 | X59 |

HUSQVARNA

| | | | | | | |
|---------------------------|------------|------|------|------|------|-----|
| All Models TE/TC/WR/CR/AE | | 89 | 2400 | EN10 | T | |
| 50 | Husky Boy | 01 - | 2377 | MX10 | T | |
| CR 50 | Pro Senior | 06 - | NA | | 1128 | X59 |
| CR 50 | Senior | 06 - | NA | | 1128 | X59 |
| WRS 50 | | 98 - | 2377 | EN10 | T | |

T = Tambour / Mechanical Drum / Strommel / Tamburo / Tambor



HUSQVARNA

| | | | | | | |
|---------|--------|---------|------|------|------|-----|
| CR 125 | | 05 - | 2352 | MX10 | 1108 | X59 |
| CR 125 | | 91 - 95 | 2400 | MX10 | 2306 | X59 |
| CR 125 | | 96 - 04 | 2352 | MX10 | 2353 | X59 |
| CR 125 | | 85 - 90 | 2249 | MX10 | T | |
| CX 125 | | 84 - 85 | 2249 | MX10 | T | |
| WR 125 | | 91 - 96 | 2400 | EN10 | 2306 | X59 |
| WR 125 | | 97 - | 2352 | EN10 | 2353 | X59 |
| WR 125 | | 85 - 90 | 2400 | EN10 | T | |
| WRE 125 | | 96 - | 2352 | EN10 | 2353 | X59 |
| WRK 125 | | 90 | 2400 | EN10 | 2306 | X59 |
| CR 240 | | 84 - 85 | 2249 | MX10 | T | |
| WR 240 | | 91 - | 2400 | EN10 | 2306 | X59 |
| WR 240 | | 87 - 90 | 2400 | EN10 | T | |
| WRK 240 | | 90 | 2400 | EN10 | 2306 | X59 |
| WR 250 | | 90 - 96 | 2400 | EN10 | 2306 | X59 |
| WR 250 | | 97 - | 2352 | EN10 | 2353 | X59 |
| CR 250 | | 85 - 87 | 2249 | MX10 | T | |
| CR 250 | | 91 - 96 | 2400 | MX10 | 2306 | X59 |
| CR 250 | | 97 - 04 | 2352 | MX10 | 2353 | X59 |
| CR 250 | | 05 - | 2352 | MX10 | 1108 | X59 |
| XC 250 | | - 85 | 2249 | MX10 | T | |
| TC 250 | | 04 - | 2352 | MX10 | 1108 | X59 |
| TC 250 | | 02 - 03 | 2352 | MX10 | 2353 | X59 |
| TE 250 | | 02 - | 2352 | EN10 | 2353 | X59 |
| WR 250 | | 87 - 90 | 2400 | EN10 | T | |
| XC 250 | | 87 - 90 | 2400 | MX10 | T | |
| WR 260 | | 90 - | 2400 | EN10 | 2306 | X59 |
| TE 350 | | 96 - | 2352 | EN10 | 2353 | X59 |
| TE 350 | Enduro | 90 | 2400 | EN10 | 2306 | X59 |
| WR 360 | | 97 - | 2352 | EN10 | 2353 | X59 |
| WR 360 | | 96 | 2400 | EN10 | 2306 | X59 |
| TE 400 | | 01 - | 2352 | EN10 | 2353 | X59 |
| WR 400 | Enduro | 85 - | 2249 | EN10 | T | |
| WR 400 | | 87 - | 2400 | EN10 | T | |
| TE 410 | | 97 - | 2352 | EN10 | 2353 | X59 |
| TE 410 | | 96 | 2400 | EN10 | 2306 | X59 |
| 430 | Auto | 87 - | 2400 | EN10 | T | |
| 430 | Enduro | 85 - | 2249 | EN10 | T | |
| CR 430 | | 87 - | 2400 | MX10 | T | |
| WR 430 | | 87 - | 2400 | EN10 | T | |
| XC 430 | | 87 - | 2400 | MX10 | T | |
| TC 450 | | 04 - | 2352 | MX10 | 1108 | X59 |
| TC 450 | | 02 - 03 | 2352 | MX10 | 2353 | X59 |
| TE 450 | | 02 - | 2352 | EN10 | 2353 | X59 |
| CR 500 | | - 85 | 2249 | MX10 | T | |
| CR 500 | | 86 - | 2249 | MX10 | T | |
| XC 500 | | - 85 | 2249 | MX10 | T | |
| TC 500 | | 86 - | 2249 | MX10 | T | |
| XC 500 | | 87 - | 2400 | MX10 | T | |
| 504 | | 83 - | 2249 | EN10 | T | |
| TC 510 | | 02 - 03 | 2352 | MX10 | 2353 | X59 |
| TC 510 | | 04 - | 2352 | MX10 | 1108 | X59 |
| TE 510 | | 87 - 89 | 2400 | MX10 | T | |
| TE 510 | | 90 - | 2400 | EN10 | 2306 | X59 |
| TE 510 | | 86 - 87 | 2249 | EN10 | T | |
| TE 510 | | 02 - 03 | 2352 | EN10 | 2353 | X59 |
| TE 510 | | 04 - 05 | 2352 | EN10 | 2353 | X59 |
| TE 510 | | 06 - | 2352 | EN10 | 1108 | X59 |
| TC 570 | | 01 - | 2352 | EN10 | 2353 | X59 |
| TE 570 | | 01 - | 2352 | EN10 | 2353 | X59 |
| TC 610 | Cross | 91 - 96 | 2400 | MX10 | 2306 | X59 |
| TC 610 | Cross | 97 - | 2352 | MX10 | 2353 | X59 |
| TE 610 | | 91 - 96 | 2400 | EN10 | 2306 | X59 |
| TE 610 | | 97 - | 2352 | EN10 | 2353 | X59 |
| TE 610 | E | 06 | 2352 | EN10 | 2353 | X59 |
| TE 630 | | 10 - | 2352 | EN10 | 1108 | X59 |

JCM

| | | | | | | |
|-----|--------|----|------|------|------|-----|
| 125 | Europa | 89 | 2377 | EN10 | 2377 | X59 |
| 125 | SR | 89 | 2377 | EN10 | 2377 | X59 |
| 240 | Europa | 89 | 2377 | EN10 | 2377 | X59 |
| 240 | SR | 89 | 2377 | EN10 | 2377 | X59 |
| 325 | Europa | 89 | 2377 | EN10 | 1089 | X59 |
| 325 | SR | 89 | 2377 | EN10 | 2377 | X59 |

KAWASAKI

| | | | | | | |
|--------|---------------|---------|------|------|------|-----|
| KMX 50 | | 88 - | 2469 | MX10 | T | |
| KX 65 | | 00 - | 1034 | MX10 | 2408 | X59 |
| KX 80 | E / G / H / J | 84 - 87 | 2469 | MX10 | T | |

KAWASAKI

| | | | | | | |
|----------|------------------------|---------|------|------|------|-----|
| KX 80 | L / N / R-R6 | 88 - 96 | 2469 | MX10 | 2328 | X59 |
| KD 80 | N1 / N3 | 88 - 90 | 2469 | MX10 | T | |
| KMX 80 | | 87 - | 2469 | MX10 | T | |
| KX 80 | | 97 - 00 | 2750 | MX10 | 2328 | X59 |
| KX 85 | | 01 - | 2750 | MX10 | 2328 | X59 |
| KX 100 | | 88 - 92 | 2469 | MX10 | 2328 | X59 |
| KX 100 | B5 / B6 | 95 - 96 | 2469 | MX10 | 2328 | X59 |
| KX 100 | B7 | 97 - | 2750 | MX10 | 2328 | X59 |
| KDX 125 | A / B | 90 - | 2469 | MX10 | 2299 | X59 |
| KX 125 | B1 | 82 | 2469 | MX10 | T | |
| KX 125 | B2 / C1 / D1 | 83 - 85 | 2306 | MX10 | T | |
| KX 125 | E1 | 86 | 2306 | MX10 | 2306 | X59 |
| KX 125 | E2 / F1 | 87 - 88 | NA | | 2306 | X59 |
| KX 125 | G / H / J | 89 - 93 | 2288 | MX10 | 2299 | X59 |
| KX 125 | K1 | 94 | 2300 | MX10 | 2299 | X59 |
| KX 125 | | 95 - | 2300 | MX10 | 2314 | X59 |
| KMX 125 | | 86 | 2469 | MX10 | 2306 | X59 |
| KMX 125 | | 87 - 02 | 2469 | MX10 | 2306 | X59 |
| KDX 200 | C | 86 - 88 | 2306 | EN10 | T | |
| KDX 200 | SR / E1 / E4 | 89 - 92 | 2306 | EN10 | 2299 | X59 |
| KDX 200 | E5 | 93 | 2288 | EN10 | 2299 | X59 |
| KDX 200 | E6 / H1 / H2 / H3 | 94 - 99 | 2300 | EN10 | 2299 | X59 |
| KDX 220 | R A4 | 97 - | 2300 | EN10 | 2299 | X59 |
| KL 250 | Super Sherpa | 98 - | 2750 | MX10 | 2306 | X59 |
| KLX 250 | D1-D4 / ES | 93 - 96 | 2300 | EN10 | 2299 | X59 |
| KX 250 | B1 | 82 | 2469 | MX10 | T | |
| KX 250 | C1 / C2 / D1 | 83 - 85 | 2306 | MX10 | T | |
| KX 250 | D2 | 86 | 2306 | MX10 | 2306 | X59 |
| KX 250 | E1 / F1 | 87 - 88 | NA | | 2306 | X59 |
| KX 250 | G1 / H1 / H2 / J1 / J2 | 89 - 93 | 2288 | MX10 | 2299 | X59 |
| KX 250 | K1 | 94 | 2300 | MX10 | 2299 | X59 |
| KX 250 | | 95 - | 2300 | MX10 | 2314 | X59 |
| KDX 250 | SR / D1 / D2 / D3 / D4 | 91 - 94 | 2288 | EN10 | 2299 | X59 |
| KLX 250 | | 98 - 07 | 2300 | EN10 | 2314 | X59 |
| KX-F 250 | | 04 - | 2300 | MX10 | 1103 | X59 |
| KLX 300 | R A2 | 97 - | 2300 | EN10 | 2314 | X59 |
| KLR 350 | | 85 - | 2306 | EN10 | T | |
| KLX 400 | R / SR | 03 - | 2300 | EN10 | 2314 | X59 |
| KLX 450 | R | 07 - | 2300 | MX10 | 1103 | X59 |
| KX-F 450 | | 06 - 08 | 2300 | MX10 | 1103 | X59 |
| KX-F 450 | Efi | 09 - | 2300 | MX10 | 1103 | X59 |
| KX 500 | A1 / A2 / B1 | 83 - 85 | 2306 | MX10 | T | |
| KX 500 | B2 | 86 | 2306 | MX10 | 2306 | X59 |
| KX 500 | C1 / D1 | 87 - 88 | NA | | 2306 | X59 |
| KX 500 | E1 / E2 / E3 / E4 / E5 | 89 - 93 | 2288 | MX10 | 2299 | X59 |
| KX 500 | E6 / E7 | 94 - 95 | 2300 | MX10 | 2299 | X59 |
| KX 500 | E8 / E9 | 96 - | 2300 | MX10 | 2314 | X59 |
| KLX 650 | R | 93 - 95 | 2300 | MX10 | 2299 | X59 |
| KLX 650 | R D1 | 96 | 2300 | MX10 | 2314 | X59 |

KRAM IT

| | | | | | | |
|--------|--|---------|------|------|------|-----|
| ER 125 | | 89 - 93 | 2400 | EN10 | 2306 | X59 |
| GS 250 | | 97 - | 2352 | EN10 | 2353 | X59 |
| MC 250 | | 89 | 2400 | MX10 | 2306 | X59 |
| MX 250 | | 97 - | 2352 | MX10 | 2353 | X59 |
| ER 300 | | 89 | 2400 | EN10 | 2306 | X59 |

KTM

| | | | | | | |
|---------|------------------|---------|------|------|------|-----|
| MX 50 | | 91 | 2249 | MX10 | T | |
| SX 50 | Pro Junior LC | 02 - | 1128 | MX10 | T | |
| SX 50 | Pro Senior LC | 02 - 03 | 1128 | MX10 | T | |
| SX 50 | Pro Senior LC | 04 - | 1128 | MX10 | 1128 | X59 |
| SX 50 | Senior Adventure | 04 - | 1128 | MX10 | T | |
| GXE 50 | | 87 - | 2249 | EN10 | T | |
| GXE 50 | | 89 - | 2249 | EN10 | T | |
| GXR 50 | | 89 - | 2249 | EN10 | T | |
| MX 50 | | 87 - 91 | 2249 | MX10 | T | |
| SM 50 | | 06 - | 1128 | MX10 | 1128 | X59 |
| SX 60 | | 99 - | 2377 | MX10 | T | |
| SX 65 | | 00 - 01 | 2377 | MX10 | 1089 | X59 |
| SX 65 | | 02 - 03 | 1078 | MX10 | 1089 | X59 |
| SX 65 | | 04 - 08 | 1078 | MX10 | 1128 | X59 |
| SX 65 | | 09 - | 1078 | MX10 | 1078 | X59 |
| MX 80 | | 86 - 92 | 2249 | MX10 | T | |
| MX 85 | | 90 | 2249 | MX10 | T | |
| SX 85 | | 03 - 10 | 1078 | MX10 | 1078 | X59 |
| SX 85 | | 11 - | 1078 | MX10 | 1219 | X59 |
| EXC 125 | | 90 | 2399 | EN10 | 2399 | X59 |
| EXC 125 | Enduro | 99 - 03 | 2352 | EN10 | 2353 | X59 |

T = Tambour / Mechanical Drum / Strommel / Tamburo / Tambor

KTM

| | | | | | | |
|-----------|--------------------|---------|------|------|------|-----|
| EXC 125 | Enduro | 04 - | 2352 | EN10 | 1108 | X59 |
| GS 125 | | 88 | 2399 | EN10 | 2399 | X59 |
| GS 125 | | 89 - 90 | 2306 | EN10 | 2306 | X59 |
| GS 125 | | 92 - | 2352 | EN10 | 2306 | X59 |
| LC 125 | | 85 | 2249 | EN10 | T | |
| LC 125 | | 86 - | 2249 | EN10 | 2249 | X59 |
| MX 125 | | 85 | 2249 | MX10 | T | |
| MX 125 | | 86 | 2249 | MX10 | 2249 | X59 |
| MX 125 | | 88 | 2399 | MX10 | 2399 | X59 |
| MX 125 | | 89 - 90 | 2306 | MX10 | 2306 | X59 |
| MX 125 | | 92 - 93 | 2352 | MX10 | 2306 | X59 |
| SX 125 | | 96 - 03 | 2352 | MX10 | 2353 | X59 |
| SX 125 | | 04 - | 2352 | MX10 | 1108 | X59 |
| XC 125 | | 85 | 2249 | MX10 | T | |
| XC 125 | | 86 - | 2249 | MX10 | 2249 | X59 |
| SX 144 | | 07 - 08 | 2352 | MX10 | 1108 | X59 |
| SX 150 | | 09 - | 2352 | MX10 | 1108 | X59 |
| EXC 200 | Enduro | 99 - 03 | 2352 | EN10 | 2353 | X59 |
| EXC 200 | Enduro | 04 - | 2352 | EN10 | 1108 | X59 |
| SX 200 | | 02 | 2352 | MX10 | 2353 | X59 |
| SX 200 | | 03 - 04 | 2352 | MX10 | 1108 | X59 |
| 250 | Baja | 86 - | 2249 | EN10 | T | |
| EXC 250 | | 90 | 2399 | EN10 | 2399 | X59 |
| EXC 250 | Enduro / Enduro 4T | 99 - 03 | 2352 | EN10 | 2353 | X59 |
| EXC 250 | Enduro / Enduro 4T | 04 - | 2352 | EN10 | 1108 | X59 |
| EXC-F250 | Enduro 4T | 06 - 10 | 2352 | EN10 | 1108 | X59 |
| MX 250 | Enduro VC | 87 | 2398 | MX10 | 2398 | X59 |
| GS 250 | | 88 | 2399 | EN10 | 2399 | X59 |
| GS 250 | | 89 - 90 | 2306 | EN10 | 2306 | X59 |
| LC 250 | | 85 | 2249 | EN10 | T | |
| LC 250 | | 86 | 2249 | EN10 | 2249 | X59 |
| MC 250 | | 83 - 84 | 2249 | MX10 | 2249 | X59 |
| MX 250 | | 83 - 84 | 2249 | MX10 | 2249 | X59 |
| MX 250 | | 92 - 93 | 2352 | MX10 | 2306 | X59 |
| MX 250 | | 85 | 2249 | MX10 | T | |
| MX 250 | | 86 | 2249 | MX10 | 2249 | X59 |
| MX 250 | | 88 | 2399 | MX10 | 2399 | X59 |
| MX 250 | | 89 - 90 | 2306 | MX10 | 2306 | X59 |
| SX 250 | | 96 - 02 | 2352 | MX10 | 2353 | X59 |
| SX 250 | | 03 - | 2352 | MX10 | 1108 | X59 |
| SX-F 250 | | 06 - | 2352 | MX10 | 1108 | X59 |
| XC 250 | | 85 | 2249 | MX10 | T | |
| XC 250 | | 86 - 89 | 2249 | MX10 | 2249 | X59 |
| EXC 300 | | 93 - 96 | 2352 | EN10 | 2306 | X59 |
| EXC 300 | Enduro | 99 - 03 | 2352 | EN10 | 2353 | X59 |
| EXC 300 | Enduro | 04 - | 2352 | EN10 | 1108 | X59 |
| EXC 300 | | 90 | 2399 | EN10 | 2399 | X59 |
| MX 300 | | 90 | 2306 | MX10 | 2306 | X59 |
| MX 300 | | 92 - | 2352 | MX10 | 2306 | X59 |
| XC 300 | | 85 | 2249 | MX10 | T | |
| XC 300 | | 86 - 90 | 2249 | MX10 | 2249 | X59 |
| XC 350 | /MC | - 83 | 2249 | MX10 | T | |
| GS 350 | 500 K4 | - 83 | 2249 | EN10 | T | |
| 350 | Country Cross | 85 - | 2249 | MX10 | T | |
| GS 350 | | 83 - 86 | 2249 | EN10 | T | |
| EXC 350 | | 87 | 2398 | EN10 | 2398 | X59 |
| EXC 350 | | 88 - | 2399 | EN10 | 2399 | X59 |
| GS 350 | | 87 | 2398 | EN10 | 2398 | X59 |
| GS 350 | | 88 - | 2399 | EN10 | 2399 | X59 |
| LC 4 350 | | 92 - | 2306 | EN10 | 2306 | X59 |
| MX 350 | | 87 | 2398 | MX10 | 2398 | X59 |
| MX 350 | | 88 | 2399 | MX10 | 2399 | X59 |
| XC 360 | | 96 - 97 | 2352 | EN10 | 2353 | X59 |
| MX 360 | | 96 - 97 | 2352 | MX10 | 2353 | X59 |
| SX 360 | | 96 - 97 | 2352 | MX10 | 2353 | X59 |
| EXC 380 | Enduro | 98 - | 2352 | EN10 | 2353 | X59 |
| MX 380 | | 98 - | 2352 | MX10 | 2353 | X59 |
| SX 380 | | 98 - 02 | 2352 | MX10 | 2353 | X59 |
| XC 380 | | 98 - | 2352 | MX10 | 2353 | X59 |
| XC 390 | /MC | - 83 | 2249 | MX10 | T | |
| GS 390 | | 83 - | 2249 | EN10 | T | |
| 400 | Enduro | 87 - | 2398 | EN10 | 2398 | X59 |
| EXC 400 | Racing | 00 - 03 | 2352 | EN10 | 2353 | X59 |
| EXC 400 | Racing | 04 - | 2352 | EN10 | 1108 | X59 |
| SX 400 | Racing | 00 - 02 | 2352 | MX10 | 2353 | X59 |
| SXC 400 | Tiainen Replica | 97 - | 2352 | EN10 | 2353 | X59 |
| LC4 400 | | 93 - 98 | 2352 | EN10 | 2306 | X59 |
| LC4-E 400 | Enduro | 99 - | 2352 | EN10 | 2353 | X59 |
| SC 400 | Supercompetition | 96 - 99 | 2352 | EN10 | 2353 | X59 |

KTM

| | | | | | | |
|---------------------------------|----------------------------|---------|------|------|------|-----|
| XC 420 | /MC | - 83 | 2249 | MX10 | T | |
| EXC 450 | | 03 | 2352 | EN10 | 2353 | X59 |
| EXC 450 | Racing | 04 - | 2352 | EN10 | 1108 | X59 |
| SX 450 | | 03 - | 2352 | MX10 | 1108 | X59 |
| XC-F 450 | | 08 - | 2352 | MX10 | 1108 | X59 |
| MC 495 | Leleu | 82 - 83 | 2249 | MX10 | T | |
| MX 495 | Leleu | 82 - 83 | 2249 | MX10 | T | |
| MX 500 | | 92 - 93 | 2352 | MX10 | 2306 | X59 |
| XC 500 | /MC | - 83 | 2249 | MX10 | T | |
| GS 500 | 500K4 Enduro | 83 - | 2249 | EN10 | T | |
| LC 500 | | 85 | 2249 | EN10 | T | |
| LC 500 | | 86 - | 2249 | EN10 | 2249 | X59 |
| MX 500 | | 85 | 2249 | MX10 | T | |
| MX 500 | | 86 | 2249 | MX10 | 2249 | X59 |
| MX 500 | | 87 | 2398 | MX10 | 2398 | X59 |
| MX 500 | | 88 | 2399 | MX10 | 2399 | X59 |
| MX 500 | | 89 - 91 | 2306 | MX10 | 2306 | X59 |
| SX-F 505 | | 07 - 08 | 2352 | MX10 | 1108 | X59 |
| XC-F 505 | | 09 - | 2352 | MX10 | 1108 | X59 |
| EXC 520 | Racing | 00 - 02 | 2352 | EN10 | 2353 | X59 |
| SX 520 | Racing | 00 - 02 | 2352 | MX10 | 2353 | X59 |
| MXC 525 | Desert | 03 - 04 | 2352 | MX10 | 2353 | X59 |
| EXC 525 | Racing | 03 | 2352 | EN10 | 2353 | X59 |
| EXC 525 | Racing | 04 - | 2352 | EN10 | 1108 | X59 |
| SX 525 | Racing | 03 | 2352 | MX10 | 2353 | X59 |
| SX 525 | Racing | 04 - 06 | 2352 | MX10 | 1108 | X59 |
| EXC 530 | Racing | 08 | 2352 | MX10 | 1108 | X59 |
| SXC 540 | Tiainen Replica | 99 - 00 | 2352 | MX10 | 2353 | X59 |
| LC4 550 | | 87 - | 2398 | EN10 | 2398 | X59 |
| MX 550 | | 87 - | 2398 | MX10 | 2398 | X59 |
| MC 600 | | 88 - | 2398 | MX10 | 2398 | X59 |
| LC4 600 | Enduro | 88 - | 2398 | EN10 | 2398 | X59 |
| 4T 600 | Enduro | 84 - | 2249 | EN10 | T | |
| LC4 600 | Six Days | 92 - | 2352 | EN10 | 2306 | X59 |
| EXC 600 | | 87 | 2398 | EN10 | 2398 | X59 |
| EXC 600 | | 88 | 2399 | EN10 | 2399 | X59 |
| GS 600 | | 85 | 2249 | EN10 | T | |
| LC4 600 | | 88 - | 2398 | EN10 | 2398 | X59 |
| MX 600 | | 87 | 2398 | MX10 | 2398 | X59 |
| MX 600 | | 88 | 2399 | MX10 | 2399 | X59 |
| XC 600 | Cross / XCE Cross | 85 | 2249 | MX10 | T | |
| EGS 620 | Enduro / EGS-E | 96 - 99 | 2352 | EN10 | 2353 | X59 |
| EGS 620 | Adventure / Rallye / EGS-E | 99 | 2352 | EN10 | 2353 | X59 |
| LC4 620 | Supercompetition | 96 - 00 | 2352 | MX10 | 2353 | X59 |
| LC4 620 | SX | 95 - 99 | 2352 | MX10 | 2353 | X59 |
| SXC 625 | | 03 - 04 | 2352 | MX10 | 2353 | X59 |
| LC4 640 | Adventure R | 00 | 2352 | EN10 | 2353 | X59 |
| LC4 640 | Adventure | 01 - 02 | 2352 | EN10 | 2353 | X59 |
| LC4 640 | Adventure (2 sets) | 03 - 07 | 2352 | EN10 | 2353 | X59 |
| LC4 640 | E Enduro | 99 - | 2352 | EN10 | 2353 | X59 |
| LC4 660 | Rally | 01 - | 2352 | MX10 | 2353 | X59 |
| 690 | Enduro | 08 - | NA | EN10 | 2353 | X59 |
| 690 | Enduro R | 09 - | NA | EN10 | 2353 | X59 |
| MX 125 / 250 / 300 / 500 | | 89 - 91 | 2306 | EN10 | 2306 | X59 |
| MXC 125 / 250 / 300 / 500 / 550 | | 92 - 93 | 2352 | MX10 | 2306 | X59 |
| | Baja | 86 - | 2249 | EN10 | T | |
| | Country / Baja | 85 | 2249 | MX10 | T | |
| MX | Enduro / VC | 87 - | 2398 | EN10 | 2398 | X59 |
| | GS / EXC / Enduro models | 91 | 2399 | EN10 | 2306 | X59 |

LEM

| | | | | | | |
|-------|-----------------|------|------|------|------|-----|
| 50 | R2 / R3 / R3 XC | 03 - | 1128 | MX10 | 1128 | X59 |
| RX 65 | | 05 - | 1128 | MX10 | 1128 | X59 |

MAICO

| | | | | | | |
|--------|---------------|------|------|------|------|-----|
| | All Models | 89 | 2399 | MX10 | 2399 | X59 |
| | All Models | 91 | 2399 | MX10 | 2306 | X59 |
| C-1 50 | Hard Enduro | 99 - | 2469 | MX10 | T | |
| X-1 50 | SuperCross | 99 - | 2469 | MX10 | T | |
| | 250 Motocross | 99 - | 2352 | MX10 | 2353 | X59 |
| | 250 Enduro | 99 - | 2352 | EN10 | 2353 | X59 |
| GP 250 | All Models | 89 | 2399 | MX10 | 2399 | X59 |
| GP 250 | E | 87 - | 2387 | MX10 | 2387 | X59 |
| GM 250 | LC | 85 - | 2249 | MX10 | T | |
| GP 250 | Motocross | 87 - | 2387 | MX10 | 2387 | X59 |
| GM 250 | Star | 86 - | 2387 | MX10 | 2387 | X59 |
| MD 250 | | 83 - | 2249 | MX10 | 2249 | X59 |
| | 350 | 93 - | 2399 | MX10 | 2399 | X59 |
| GP 400 | All Models | 89 | 2399 | MX10 | 2399 | X59 |



MAICO

| | | | | | |
|-------------------|------|------|------|------|-----|
| GP 400 E | 87 - | 2387 | MX10 | 2387 | X59 |
| GP 400 Motocross | 87 - | 2387 | MX10 | 2387 | X59 |
| 500 Motocross | 99 - | 2352 | MX10 | 2353 | X59 |
| 500 Enduro | 99 - | 2352 | EN10 | 2353 | X59 |
| GP 500 All Models | 89 | 2399 | MX10 | 2399 | X59 |
| GP 500 E | 87 - | 2387 | MX10 | 2387 | X59 |
| GM 500 LC | 85 - | 2249 | MX10 | T | |
| GP 500 Motocross | 87 - | 2387 | MX10 | 2387 | X59 |
| GM 500 Star | 86 - | 2387 | MX10 | 2387 | X59 |
| 500 | 93 - | 2399 | MX10 | 2399 | X59 |
| GP 550 | 87 - | 2387 | MX10 | 2387 | X59 |

MALAGUTI

| | | | | | |
|--------------------|------|------|------|----|--|
| 50 Enduro | 85 - | 2249 | EN10 | T | |
| MDX 50 | 86 - | 1089 | MX10 | NA | |
| MDX 50 Gold Enduro | 87 - | 2260 | EN10 | NA | |
| MEX 50 | 86 - | 2466 | MX10 | T | |
| MFX 50 | 86 - | 2466 | MX10 | T | |
| MLX 50 Enduro | 87 - | 2260 | EN10 | NA | |
| MRX 50 | 89 | 2249 | EN10 | T | |
| MGX 425 Ronco | 87 - | 2466 | MX10 | T | |

MONTESA

| | | | | | |
|----------------|---------|------|------|------|-----|
| 80 Cross | 96 - | 2352 | MX10 | 2353 | X59 |
| 80 Junior | 96 - | 2469 | MX10 | 2328 | X59 |
| 125 Cota | 88 | 2377 | EN10 | 2377 | X59 |
| 125 | 96 - | 2352 | EN10 | 2353 | X59 |
| 250 E | 95 - | 2352 | EN10 | 2353 | X59 |
| 260 Evasion | 92 | 2377 | EN10 | 2249 | X59 |
| 304 Cota | 88 | 2377 | EN10 | 2377 | X59 |
| 307 Cota | 89 | 2377 | EN10 | 2377 | X59 |
| 307 Cota Trial | 88 - | 2377 | EN10 | 2377 | X59 |
| 309 Cota | 89 - | 2377 | EN10 | 2249 | X59 |
| 310 Cota | 89 - | 2377 | EN10 | 2249 | X59 |
| 311 Cota Trial | 92 | 2377 | EN10 | 2249 | X59 |
| 314 Cota | 95 - | 2377 | EN10 | 2377 | X59 |
| 315 Cota R | 97 - | 2377 | EN10 | 2377 | X59 |
| 320 Cota | 96 - | 2352 | EN10 | 2353 | X59 |
| 335 Cota | 87 - 91 | 2377 | EN10 | 2377 | X59 |
| M7 360 Enduro | 85 | 2377 | EN10 | T | |

POLINI

| | | | | | |
|----------|------|------|------|------|-----|
| X1 50 R | 04 - | 1128 | MX10 | 1128 | X59 |
| X3 50 R | 04 - | 1128 | MX10 | 1128 | X59 |
| X5 65 RP | 05 - | 1128 | MX10 | 1128 | X59 |

PRAGA

| | | | | | |
|--------|------|------|------|------|-----|
| ED 250 | 99 - | 2352 | EN10 | 2353 | X59 |
| CD 610 | 99 - | 2352 | EN10 | 2353 | X59 |

RIEJU

| | | | | | |
|--------------|---------|------|------|------|-----|
| MR 80 Cross | 87 | 2377 | MX10 | T | |
| MR 80 Enduro | 87 | 2377 | EN10 | T | |
| 250 Marathon | 09 - 10 | 2352 | EN10 | 1108 | X59 |
| 450 Marathon | 09 - 10 | 2352 | EN10 | 1108 | X59 |

SHERCO

| | | | | | |
|-------------------------------------|---------|------|------|------|-----|
| 80 Trial 0.8 (2T) | 01 - 04 | 2377 | EN10 | NA | |
| 125 Trial 1.25 (2T) | 99 - 05 | 2377 | EN10 | 2377 | X59 |
| 125 SE 1.25 F Enduro (4T) | 10 - | 1146 | EN10 | NA | |
| 200 Trial 2.0 (2T) | 99 - 05 | 2377 | EN10 | 2377 | X59 |
| 250 Trial 2.5 (2T) | 99 - 05 | 2377 | EN10 | 2377 | X59 |
| 250 Enduro 2.5i (4T) Inc. SE Models | 08 - 10 | 2352 | EN10 | 1103 | X59 |
| 250 SX 2.5i F Moto Cross | 10 - | 2352 | MX10 | 1103 | X59 |
| 290 Trial 2.9 (2T) | 99 - 05 | 2377 | EN10 | 2377 | X59 |
| 300 Enduro SE 3.0i (4T) | 10 - | 2352 | EN10 | 1103 | X59 |
| 450 Enduro 4.5i (4T) | 04 - 10 | 2352 | EN10 | 1103 | X59 |
| 510 Enduro 5.1i F | 07 - 10 | 2352 | EN10 | 1103 | X59 |

SUZUKI

| | | | | | |
|-----------------------------|---------|------|------|------|-----|
| RME 50 | 10 - | NA | | 1076 | X59 |
| RM 65 | 03 - 05 | 1034 | MX10 | 2408 | X59 |
| RM 80 G / H / J / K | 86 - 89 | 2469 | MX10 | T | |
| RM 80 L / M / N / P / R / S | 90 - 95 | 2469 | MX10 | 2469 | X59 |
| RM 80 T | 96 - 01 | 2914 | MX10 | 2469 | X59 |
| RM 85 / L | 02 - 04 | 2914 | MX10 | 2469 | X59 |
| RM 85 / L | 05 - 10 | 2750 | MX10 | 1152 | X59 |
| RM 100 | 03 | 2750 | MX10 | 2328 | X59 |
| DR-Z 125 L | 03 - 09 | 2914 | MX10 | T | |

SUZUKI

| | | | | | |
|-----------------------------------|---------|------|------|------|-----|
| RM 125 F / G | 85 - 86 | 2387 | MX10 | T | |
| RM 125 H | 87 | 2288 | MX10 | T | |
| RM 125 J | 88 | 2288 | MX10 | 2328 | X59 |
| RM 125 K / L / M | 89 - 91 | 2288 | MX10 | 2299 | X59 |
| RM 125 N / P / R / S | 92 - 95 | 2288 | MX10 | 2299 | X59 |
| RM 125 T/V/W/X/Y K1-K5 | 96 - 05 | 2300 | MX10 | 2314 | X59 |
| RM 125 K6 - K9 | 06 - 09 | 2300 | MX10 | 2314 | X59 |
| RM 125 K10 | 10 - | 2300 | MX10 | 2314 | X59 |
| RM-E 125 | 05 - | 2300 | EN10 | 1103 | X59 |
| DR-Z 250 K1 / K7 | 01 - 07 | 2300 | EN10 | 2299 | X59 |
| RM 250 F / G | 85 - 86 | 2387 | MX10 | T | |
| RM 250 H / J | 87 - 88 | 2288 | MX10 | 2328 | X59 |
| RM 250 K / L / M | 89 - 91 | 2288 | MX10 | 2299 | X59 |
| RM 250 N / P / R / S | 92 - 95 | 2288 | MX10 | 2299 | X59 |
| RM 250 T/V/W/X/Y K1-K5 | 96 - 05 | 2300 | MX10 | 2314 | X59 |
| RM 250 K6 - K9 | 06 - 09 | 2300 | MX10 | 2314 | X59 |
| RM 250 K10 | 10 - | 2300 | MX10 | 2314 | X59 |
| RME 250 | 05 - | 2300 | EN10 | 1103 | X59 |
| RMX 250 K / L / M / N / P / R / S | 89 - 95 | 2288 | EN10 | 2299 | X59 |
| RMX 250 T / V / W | 96 - 98 | 2300 | EN10 | 2299 | X59 |
| RM-Z 250 E | 04 - 09 | 2300 | EN10 | 1103 | X59 |
| RM-Z 250 Efi | 10 - | 2300 | EN10 | 1103 | X59 |
| DR-Z 400 E / S | 00 - 08 | 2300 | EN10 | 2314 | X59 |
| RM-X 450 | 05 - | 2300 | EN10 | 1103 | X59 |
| RM-Z 450 | 05 - 07 | 2300 | MX10 | 1103 | X59 |
| RM-Z 450 Efi | 08 - | 2300 | MX10 | 1103 | X59 |
| RM 500 | 85 - 86 | 2387 | MX10 | T | |
| RM 500 H | 87 - | 2288 | MX10 | 2328 | X59 |

SWM

| | | | | | |
|--------------|------|------|------|------|-----|
| 125 GP | 86 - | 2249 | MX10 | 2249 | |
| 125 S1 - S2 | | 2249 | MX10 | T | |
| 250 S1 - S2 | | 2249 | MX10 | T | |
| 250 Explorer | 86 | 2249 | MX10 | 2249 | X59 |
| 250 Pioner | 86 | 2249 | MX10 | 2249 | X59 |
| TRL 329 MJ | 86 - | 2249 | EN10 | T | |

TM

| | | | | | |
|--------------------------------------|---------|------|------|------|-----|
| 80/85/100 Junior Cross (Small Wheel) | 02 - 04 | 2352 | MX10 | 2353 | X59 |
| 80/85/100 Junior Cross | 05 - 07 | 2352 | MX10 | 2314 | X59 |
| 80/85/100 (Big Wheel) | 02 - 04 | 2352 | MX10 | 2353 | X59 |
| 80 Enduro | 96 - 00 | 2352 | EN10 | 2353 | X59 |
| 80/85 Minicross / Junior | 96 - 00 | 2352 | MX10 | 2314 | X59 |
| 80/85 Cross | 96 - 01 | 2352 | MX10 | 2353 | X59 |
| MX 85 JR | 02 - 10 | 2352 | MX10 | 2314 | X59 |
| 125 Cross | 95 - 00 | 2352 | MX10 | 2353 | X59 |
| MX 125 (2T) | 01 - 10 | 2352 | MX10 | 2314 | X59 |
| 125 Enduro | 95 - 00 | 2352 | EN10 | 2353 | X59 |
| EN 125 Enduro (2T) | 01 - 10 | 2352 | EN10 | 2314 | X59 |
| EN 144 (2T) | 08 - 10 | 2352 | EN10 | 2314 | X59 |
| MX 144 (2T) | 08 - 10 | 2352 | MX10 | 2314 | X59 |
| 250 Enduro | 95 - 00 | 2352 | EN10 | 2353 | X59 |
| EN 250 F Enduro (4T) | 04 - 10 | 2352 | EN10 | 2314 | X59 |
| EN 250 Enduro (2T) | 01 - 10 | 2352 | EN10 | 2314 | X59 |
| EN 250 Fi | 10 | 2352 | EN10 | 2314 | X59 |
| 250 Cross | 95 - 00 | 2352 | MX10 | 2353 | X59 |
| MX 250 (2T) | 01 - 10 | 2352 | MX10 | 2314 | X59 |
| MX 250 (4T) Cross | 02 - 10 | 2352 | MX10 | 2314 | X59 |
| MX 250 Fi (4T) | 10 | 2352 | MX10 | 2314 | X59 |
| 300 Enduro (2T) | 95 - 00 | 2352 | EN10 | 2353 | X59 |
| EN 300 Enduro (2T) | 01 - 10 | 2352 | EN10 | 2314 | X59 |
| 300 Cross | 95 - 00 | 2352 | MX10 | 2353 | X59 |
| MX 300 (2T) | 01 - 10 | 2352 | MX10 | 2314 | X59 |
| MX 400 (4T) Cross | 02 - 03 | 2352 | MX10 | 2314 | X59 |
| 400 Cross (4T) | 95 - 00 | 2352 | MX10 | 2353 | X59 |
| EN 450 F (4T) | 04 - 10 | 2352 | EN10 | 2314 | X59 |
| MX 450 F (4T) | 04 - 10 | 2352 | MX10 | 2314 | X59 |
| 530 Cross (4T) | 98 - 00 | 2352 | MX10 | 2353 | X59 |
| EN 530 F (4T) | 04 - 10 | 2352 | EN10 | 2314 | X59 |
| 530 Cross (4T) | 02 - 03 | NA | MX10 | 2314 | X59 |
| MX 530 F | 05 - 10 | 2352 | MX10 | 2314 | X59 |

VERTEMATI

| | | | | | |
|--------------|------|------|------|------|-----|
| C 500 Cross | 02 - | 2352 | MX10 | 2353 | X59 |
| E 500 Enduro | 02 - | 2352 | EN10 | 2353 | X59 |



VOR

| | | | | | | |
|----|-----|------|------|------|------|-----|
| EN | 400 | 00 - | 2352 | EN10 | 2353 | X59 |
| MX | 400 | 00 - | 2352 | MX10 | 2353 | X59 |
| EN | 450 | 02 - | 2352 | EN10 | 2353 | X59 |
| MX | 450 | 02 - | 2352 | MX10 | 2353 | X59 |
| EN | 530 | 03 - | 2352 | EN10 | 2353 | X59 |
| MX | 530 | 03 - | 2352 | MX10 | 2353 | X59 |

YAMAHA

| | | | | | | |
|------|-----|----------------------------------|---------|------|------|----------|
| YZ | 80 | S / T / U / W | 86 - 89 | 2424 | MX10 | T |
| YZ | 80 | A / B / D | 90 - 92 | 2424 | MX10 | T |
| YZ | 80 | E / F / G / H1 / J1 | 93 - 01 | 2424 | MX10 | 2328 X59 |
| YZ | 85 | All models | 02 - 10 | 2424 | MX10 | 2328 X59 |
| TT-R | 125 | LW | 00 - 10 | 2424 | MX10 | T |
| WR | 125 | | 91 - 97 | 2288 | EN10 | 2299 X59 |
| WR | 125 | | 98 - 02 | 2300 | EN10 | 2314 X59 |
| YZ | 125 | N / S / T | 85 - 87 | 2792 | MX10 | T |
| YZ | 125 | U | 88 | 2792 | MX10 | 2284 X59 |
| YZ | 125 | V / W | 89 | 2288 | MX10 | 2328 X59 |
| YZ | 125 | A/B/D/E/F/G/H/J | 90 - 97 | 2288 | MX10 | 2299 X59 |
| YZ | 125 | K / L / M / N / P | 98 - 02 | 2300 | MX10 | 2314 X59 |
| YZ | 125 | R / S / T / V / W | 03 - 07 | 2300 | MX10 | 1103 X59 |
| YZ | 125 | X / Y / Z | 08 - | 1183 | MX10 | 1103 X59 |
| IT | 200 | S | 86 | 2792 | MX10 | T |
| TT | 200 | | 85 - | 2284 | MX10 | T |
| WR | 200 | R | 91 - 94 | 2288 | EN10 | 2299 X59 |
| TT | 225 | S / T | 87 - 00 | 2284 | MX10 | T |
| TT-R | 225 | | 01 - 04 | 2284 | MX10 | T |
| XT | 225 | | 86 - 91 | 2284 | MX10 | T |
| XT | 225 | E - H | 92 - 00 | 2284 | MX10 | T |
| TT | 250 | | 85 - | 2284 | MX10 | T |
| TT | 250 | | 87 - 92 | 2792 | MX10 | T |
| TT | 250 | R | 93 - 04 | 2288 | EN10 | 2299 X59 |
| TY | 250 | R | 91 - 92 | 2377 | EN10 | T |
| TY | 250 | R | 93 - 94 | 2377 | EN10 | 2377 X59 |
| TY-Z | 250 | R | 93 - 96 | 2377 | EN10 | 2377 X59 |
| TY-Z | 250 | R (Scottish) | 93 - 96 | 2284 | MX10 | 2299 X59 |
| WR | 250 | ZB / ZD / ZE / ZF / ZG / ZH / ZJ | 91 - 97 | 2288 | EN10 | 2299 X59 |
| WR | 250 | ZK / FN / FP | 98 - 02 | 2300 | EN10 | 2314 X59 |
| WR | 250 | FR / FS / FT / FV | 03 - 06 | 2300 | EN10 | 1103 X59 |
| WR | 250 | FW / FX / FY / FZ | 07 - | 2300 | EN10 | 1103 X59 |
| YZ | 250 | N / S / T (2T) | 85 - 87 | 2792 | MX10 | T |
| YZ | 250 | U (2T) | 88 | 2792 | MX10 | 2284 X59 |
| YZ | 250 | W / WRW (2T) | 89 | 2288 | MX10 | 2328 X59 |
| YZ | 250 | A / WRA / B (2T) | 90 - 91 | 2288 | MX10 | 2299 X59 |
| YZ | 250 | D / E / F / G / H / J (2T) | 92 - 97 | 2288 | MX10 | 2299 X59 |
| YZ | 250 | K / L / M (2T) | 98 - 00 | 2300 | MX10 | 2314 X59 |
| YZ | 250 | N / P (2T) | 01 - 02 | 2300 | MX10 | 2314 X59 |
| YZ | 250 | FN / FP (4T) | 01 - 02 | 2300 | MX10 | 2314 X59 |
| YZ | 250 | R / S / T / V / W (2T) | 03 - 07 | 2300 | MX10 | 1103 X59 |
| YZ | 250 | FR / FS / FT / FV (4T) | 03 - 06 | 2300 | MX10 | 1103 X59 |
| YZ | 250 | X / Y / Z (2T) | 08 - | 1183 | MX10 | 1103 X59 |
| YZ | 250 | FW / FX / FY / FZ (4T) | 07 - | 1183 | MX10 | 1103 X59 |
| TT | 350 | (1TJ) | 85 - 89 | 2792 | MX10 | T |
| TT | 350 | A (3GJ) | 90 - 95 | 2792 | MX10 | T |
| YZ | 360 | | 89 | 2288 | MX10 | 2328 X59 |
| WR | 400 | FK (4T) | 98 | 2300 | EN10 | 2299 X59 |
| WR | 400 | FL / FM / FN (4T) | 99 - 01 | 2300 | EN10 | 2314 X59 |
| YZ | 400 | FK (4T) | 98 | 2300 | MX10 | 2299 X59 |
| YZ | 400 | FL (4T) | 99 | 2300 | MX10 | 2314 X59 |
| WR | 426 | FN / FP (4T) | 00 - 02 | 2300 | EN10 | 2314 X59 |
| YZ | 426 | FM / FN / FP (4T) | 00 - 02 | 2300 | MX10 | 2314 X59 |
| WR | 450 | FR / FS / FT / FV (4T) | 03 - 06 | 2300 | EN10 | 1103 X59 |
| WR | 450 | FW / FX / FY / FZ (4T) | 07 - | 2300 | EN10 | 1103 X59 |
| YZ | 450 | FR / FS / FT / FV (4T) | 03 - 06 | 2300 | MX10 | 1103 X59 |
| YZ | 450 | FW (4T) | 07 | 2300 | MX10 | 1103 X59 |
| YZ | 450 | FX / FY / FZ (4T) | 08 - | 1183 | MX10 | 1103 X59 |
| YZ | 490 | N / S / T / U / W / A | 85 - 90 | 2792 | MX10 | T |
| WR | 500 | B | 91 | 2288 | EN10 | 2284 X59 |
| WR | 500 | ZD / ZE | 92 - 93 | 2288 | EN10 | 2299 X59 |
| TT | 600 | N | 85 - 88 | 2284 | MX10 | T |
| TT | 600 | | 90 | 2792 | MX10 | T |
| TT | 600 | E | 94 - 01 | 2352 | EN10 | 2353 X59 |
| TT | 600 | E (Belgarda) | 94 - 95 | 2352 | EN10 | 2299 X59 |
| TT | 600 | K (Belgarda) | 93 - 95 | 2352 | EN10 | 2299 X59 |
| TT | 600 | K (From 4GV 003404) | 95 - 96 | 2352 | EN10 | 2353 X59 |
| TT | 600 | R (5CH1 / 5CH2 / 5CH3) | 97 - 02 | 2352 | EN10 | 2353 X59 |
| TT | 600 | RE (5CH5) | 04 | 2352 | EN10 | 2353 X59 |

T = Tambour / Mechanical Drum / Strommel / Tamburo / Tambor

Tout-Terrain / Off-Road / Fuoristrada / Todo Terreno



QUAD/ATV

QUAD ATV



ADLY



RACING

| | | | | | | | | | |
|-----|--------------|------|---|------|------|------|------|-----|--|
| 150 | Interceptor | 05 - | 2 | 2469 | ATV1 | 2466 | ATV1 | | |
| 300 | Interceptor | 05 - | 2 | 2469 | ATV1 | 2466 | ATV1 | | |
| 300 | Cross X Over | 07 - | 2 | 1147 | ATV1 | T | | | |
| 300 | Cross X road | 07 - | 2 | 1147 | ATV1 | T | | | |
| 300 | Sport | 07 - | 2 | 1147 | ATV1 | NA | | | |
| 320 | S | 07 - | 2 | 1147 | ATV1 | T | | | |
| 320 | U | 07 - | 2 | 1147 | ATV1 | T | | | |
| 150 | ATV | 05 - | 2 | 2469 | ATV1 | 2469 | ATV1 | X59 | |
| 300 | ATV | 05 - | 2 | 2469 | ATV1 | 2469 | ATV1 | X59 | |

AEON

| | | | | | | | | | |
|-----|----------|------|--|---|--|------|------|-----|--|
| 125 | Overland | 02 - | | T | | 2326 | ATV1 | | |
| 180 | Overland | 02 - | | T | | 2326 | ATV1 | | |
| 180 | Roadster | 02 - | | T | | 2326 | ATV1 | | |
| 100 | Revo 2 | 04 - | | T | | 2469 | ATV1 | X59 | |

ARCTIC CAT

| | | | | | | | | | |
|------|--------------------------------|---------|---|------|------|------|------|-----|--|
| 50 | DVX | 06 - | | T | | 2326 | ATV1 | | |
| 90 | DVX | 06 - | | T | | 2326 | ATV1 | | |
| 250 | 2X4 | 05 - | 2 | 1171 | ATV1 | 1171 | ATV1 | X59 | |
| 250 | 2X4 / 4x4 | 99 - 04 | 2 | 2926 | ATV1 | 2926 | ATV1 | | |
| 300 | 2x4 / 4x4 | 98 - 04 | 2 | 2926 | ATV1 | 2926 | ATV1 | | |
| 300 | 4x4 | 05 - | 2 | 1171 | ATV1 | 1171 | ATV1 | X59 | |
| 375 | 2x4 / 4x4 | 02 - | 2 | 2926 | ATV1 | 2926 | ATV1 | | |
| 400 | 2x4 / 4x4 | 98 - 04 | 2 | 2926 | ATV1 | 2926 | ATV1 | | |
| 400 | DVX | 04 - | 2 | 2328 | ATV1 | 2328 | ATV1 | X59 | |
| 400 | 2x4 / 4x4 (FIS) | 05 - | 2 | 1171 | ATV1 | 1171 | ATV1 | X59 | |
| 400 | 2x4/4x4 (FIS)(Man. Hand Brake) | 05 - | 2 | 2926 | ATV1 | 2926 | ATV1 | | |
| 400 | TBX 4x4 | 04 - | 2 | 2926 | ATV1 | 2926 | ATV1 | | |
| 454 | Bear Cat 2x4 / 4x4 | 96 - 98 | 2 | 2926 | ATV1 | 2926 | ATV1 | | |
| 454 | Artic Cat 4x4 | 98 - | 2 | 2926 | ATV1 | 2926 | ATV1 | | |
| 500 | 2x4 / 4x4 | 98 - 04 | 2 | 2926 | ATV1 | 2926 | ATV1 | | |
| 500 | 2x4 / 4x4 (FIS) | 02 - 04 | 2 | 2926 | ATV1 | 2926 | ATV1 | | |
| 500 | 2x4 / 4x4 (FIS) | 05 - | 2 | 1171 | ATV1 | 1171 | ATV1 | X59 | |
| 500 | TBX 4x4 | 02 - 04 | 2 | 2926 | ATV1 | 2926 | ATV1 | | |
| 500 | TBX 4x4 | 05 - | 2 | 1171 | ATV1 | 1171 | ATV1 | X59 | |
| 500 | TRV 4x4 | 03 - 04 | 2 | 2926 | ATV1 | 2926 | ATV1 | | |
| 500 | TRV 4x4 | 05 - | 2 | 1171 | ATV1 | 1171 | ATV1 | X59 | |
| 550 | TRV | 09 - | 2 | 1171 | ATV1 | 1171 | ATV1 | X59 | |
| 650 | H1 4x4 Aut. | 05 - | 2 | 1171 | ATV1 | 1171 | ATV1 | X59 | |
| 650 | V2 4x4 Aut LE | 05 - | 2 | 1171 | ATV1 | 1171 | ATV1 | X59 | |
| 650 | V2 4x4 Aut. | 05 - | 2 | 1171 | ATV1 | 1171 | ATV1 | X59 | |
| 700 | TRV | 09 - | 2 | 1171 | ATV1 | 1171 | ATV1 | X59 | |
| 1000 | TRV Thunder Cat | 09 - | 2 | 1171 | ATV1 | 1171 | ATV1 | X59 | |
| 1000 | TRV | 09 - | 2 | 1171 | ATV1 | 1171 | ATV1 | X59 | |

BOMBARDIER

| | | | | | | | | | |
|-----|-----------------|---------|-----|------|------|------|------|-----|--|
| 200 | Rally 2x4 | 03 - 04 | 2 | 2469 | ATV1 | T | | | |
| 200 | Rally 2x4 | 05 - | 2 | 2469 | ATV1 | 2923 | ATV1 | X59 | |
| 250 | DS | 06 - | 2 | 1147 | ATV1 | 1147 | ATV1 | | |
| 330 | Outlander | 03 - | L 1 | 2923 | ATV1 | 2923 | ATV1 | X59 | |
| 330 | Outlander | 03 - | R 1 | 1102 | ATV1 | | | | |
| 400 | Outlander | 03 - | L 1 | 2923 | ATV1 | 2923 | ATV1 | X59 | |
| 400 | Outlander | 03 - | R 1 | 1102 | ATV1 | | | | |
| 400 | Outlander Max | 03 - | L 1 | 2923 | ATV1 | 2923 | ATV1 | X59 | |
| 400 | Outlander Max | 03 - | R 1 | 1102 | ATV1 | | | | |
| 500 | Quest | 02 - | L 1 | 2923 | ATV1 | 2923 | ATV1 | X59 | |
| 500 | Quest | 02 - | R 1 | 1102 | ATV1 | | | | |
| 500 | Traxter 4x4 | 99 - 01 | 2 | 2827 | ATV1 | 2827 | ATV1 | | |
| 500 | Traxter 4x4 | 02 - | L 1 | 2923 | ATV1 | 2923 | ATV1 | X59 | |
| 500 | Traxter 4X4 | 02 - | R 1 | 1102 | ATV1 | | | | |
| 500 | Traxter 4x4 Max | 02 - | L 1 | 2923 | ATV1 | 2923 | ATV1 | X59 | |
| 500 | Traxter 4x4 Max | 02 - | R 1 | 1102 | ATV1 | | | | |
| 650 | DS | 01 - | L 1 | 2923 | ATV1 | 2923 | ATV1 | X59 | |
| 650 | DS | 01 - | R 1 | 1102 | ATV1 | | | | |
| 650 | Quest | 02 - | L 1 | 2923 | ATV1 | 2923 | ATV1 | X59 | |
| 650 | Quest | 02 - | R 1 | 1102 | ATV1 | | | | |
| 650 | Quest Max | 02 - | L 1 | 2923 | ATV1 | 2923 | ATV1 | X59 | |
| 650 | Quest Max | 02 - | R 1 | 1102 | ATV1 | | | | |
| 650 | Traxter Max | 03 - | L 1 | 2923 | ATV1 | 2923 | ATV1 | X59 | |
| 650 | Traxter Max | 03 - | R 1 | 1102 | ATV1 | | | | |
| 800 | Outlander | 06 - | L 1 | 2923 | ATV1 | 2923 | ATV1 | X59 | |
| 800 | Outlander | 06 - | R 1 | 1102 | ATV1 | | | | |
| 800 | Outlander XT | 06 - | L 1 | 2923 | ATV1 | 2923 | ATV1 | X59 | |
| 800 | Outlander XT | 06 - | R 1 | 1102 | ATV1 | | | | |

CAN-AM

| | | | | | | | | | |
|-----|------|------|---|------|------|------|------|-----|--|
| 90 | DS X | 08 - | 2 | 2469 | ATV1 | 2469 | ATV1 | X59 | |
| 250 | DS | 07 - | 2 | 1147 | ATV1 | 1147 | ATV1 | | |

CAN-AM



RACING

| | | | | | | | | | |
|-----|-------------------|------|-----|------|------|------|------|-----|--|
| 400 | Outlander EFI | 09 - | L 1 | 2923 | ATV1 | 1102 | ATV1 | X59 | |
| 400 | Outlander EFI | 09 - | R 1 | 1102 | ATV1 | | | | |
| 400 | Outlander Max STD | 07 - | L 1 | 2923 | ATV1 | 1102 | ATV1 | X59 | |
| 400 | Outlander Max STD | 07 - | R 1 | 1102 | ATV1 | | | | |
| 400 | Outlander STD | 07 - | L 1 | 2923 | ATV1 | 1102 | ATV1 | X59 | |
| 400 | Outlander STD | 07 - | R 1 | 1102 | ATV1 | | | | |
| 400 | Outlander MAX XT | 07 - | L 1 | 2923 | ATV1 | 1102 | ATV1 | X59 | |
| 400 | Outlander MAX XT | 07 - | R 1 | 1102 | ATV1 | | | | |
| 400 | Outlander XT | 07 - | L 1 | 2923 | ATV1 | 1102 | ATV1 | X59 | |
| 400 | Outlander XT | 07 - | R 1 | 1102 | ATV1 | | | | |
| 450 | DS | 08 - | 2 | NA | ATV1 | 2927 | ATV1 | X59 | |
| 500 | Outlander Max STD | 07 - | L 1 | 2923 | ATV1 | 1102 | ATV1 | X59 | |
| 500 | Outlander Max STD | 07 - | R 1 | 1102 | ATV1 | | | | |
| 500 | Outlander MAX XT | 07 - | L 1 | 2923 | ATV1 | 1102 | ATV1 | X59 | |
| 500 | Outlander MAX XT | 07 - | R 1 | 1102 | ATV1 | | | | |
| 500 | Outlander STD | 07 - | L 1 | 2923 | ATV1 | 1102 | ATV1 | X59 | |
| 500 | Outlander STD | 07 - | R 1 | 1102 | ATV1 | | | | |
| 500 | Outlander XT | 07 - | L 1 | 2923 | ATV1 | 1102 | ATV1 | X59 | |
| 500 | Outlander XT | 07 - | R 1 | 1102 | ATV1 | | | | |
| 500 | Renegade | 08 - | L 1 | 2923 | ATV1 | 1102 | ATV1 | X59 | |
| 500 | Renegade | 08 - | R 1 | 1102 | ATV1 | | | | |
| 650 | Outlander Max STD | 07 - | L 1 | 2923 | ATV1 | 1102 | ATV1 | X59 | |
| 650 | Outlander Max STD | 07 - | R 1 | 1102 | ATV1 | | | | |
| 650 | Outlander MAX XT | 07 - | L 1 | 2923 | ATV1 | 1102 | ATV1 | X59 | |
| 650 | Outlander MAX XT | 07 - | R 1 | 1102 | ATV1 | | | | |
| 650 | Outlander STD | 07 - | L 1 | 2923 | ATV1 | 1102 | ATV1 | X59 | |
| 650 | Outlander STD | 07 - | R 1 | 1102 | ATV1 | | | | |
| 650 | Outlander XT | 07 - | L 1 | 2923 | ATV1 | 1102 | ATV1 | X59 | |
| 650 | Outlander XT | 07 - | R 1 | 1102 | ATV1 | | | | |
| 800 | Outlander Max LTD | 07 - | L 1 | 2923 | ATV1 | 1102 | ATV1 | X59 | |
| 800 | Outlander Max LTD | 07 - | R 1 | 1102 | ATV1 | | | | |
| 800 | Outlander Max STD | 07 - | L 1 | 2923 | ATV1 | 1102 | ATV1 | X59 | |
| 800 | Outlander Max STD | 07 - | R 1 | 1102 | ATV1 | | | | |
| 800 | Outlander MAX XT | 07 - | L 1 | 2923 | ATV1 | 1102 | ATV1 | X59 | |
| 800 | Outlander MAX XT | 07 - | R 1 | 1102 | ATV1 | | | | |
| 800 | Outlander STD | 07 - | L 1 | 2923 | ATV1 | 1102 | ATV1 | X59 | |
| 800 | Outlander STD | 07 - | R 1 | 1102 | ATV1 | | | | |
| 800 | Outlander XT | 07 - | L 1 | 2923 | ATV1 | 1102 | ATV1 | X59 | |
| 800 | Outlander XT | 07 - | R 1 | 1102 | ATV1 | | | | |
| 800 | Renegade Efi | 07 - | L 1 | 2923 | ATV1 | 1102 | ATV1 | X59 | |
| 800 | Renegade Efi | 07 - | R 1 | 1102 | ATV1 | | | | |
| 800 | Renegade | 08 - | L 1 | 2923 | ATV1 | 1102 | ATV1 | X59 | |
| 800 | Renegade | 08 - | R 1 | 1102 | ATV1 | | | | |
| 800 | Renegade X | 08 - | L 1 | 2923 | ATV1 | 1102 | ATV1 | X59 | |
| 800 | Renegade X | 08 - | R 1 | 1102 | ATV1 | | | | |

CANNONDALE

| | | | | | | | | | |
|-----|----------|------|-----|------|------|------|------|-----|--|
| 440 | Blaze | 03 - | L 1 | 2923 | ATV1 | 2923 | ATV1 | X59 | |
| 440 | Blaze | 03 - | R 1 | 1102 | ATV1 | | | | |
| 440 | Cannibal | 03 - | L 1 | 2923 | ATV1 | 2923 | ATV1 | X59 | |
| 440 | Cannibal | 03 - | R 1 | 1102 | ATV1 | | | | |
| 440 | Glamis | 03 - | L 1 | 2923 | ATV1 | 2923 | ATV1 | X59 | |
| 440 | Glamis | 03 - | R 1 | 1102 | ATV1 | | | | |
| 440 | Moto | 03 - | L 1 | 2923 | ATV1 | 2923 | ATV1 | X59 | |
| 440 | Moto | 03 - | R 1 | 1102 | ATV1 | | | | |
| 440 | Speed | 03 - | L 1 | 2923 | ATV1 | 2923 | ATV1 | X59 | |
| 440 | Speed | 03 - | R 1 | 1102 | ATV1 | | | | |

CPI

| | | | | | | | | | |
|----|----------|------|---|------|------|--|--|--|--|
| XS | 250 Quad | 06 - | 2 | 2469 | ATV1 | | | | |
| | 250 XS | 07 - | 2 | 1147 | ATV1 | | | | |

DAELIM

| | | | | | | | | | |
|--|-----------------|-------|---|------|------|----|--|--|--|
| | 250 Sector Quad | 05-06 | 2 | 2469 | ATV1 | NA | | | |
|--|-----------------|-------|---|------|------|----|--|--|--|

DERBI

| | | | | | | | | | |
|-----|-----------------------|------|---|------|------|------|------|-----|--|
| DXR | 200 Quad (front disc) | 04 - | 2 | 2469 | ATV1 | 2306 | ATV1 | X59 | |
| DXR | 200 Quad (front drum) | 04 - | 2 | T | | 2306 | ATV1 | X59 | |
| DXR | 250 Quad (front disc) | 04 - | 2 | 2469 | ATV1 | 2306 | ATV1 | X59 | |
| DXR | 250 Quad (front drum) | 04 - | 2 | T | | 2306 | ATV1 | X59 | |

E-TON

| | | | | | | | | | |
|-----|-----------------------|------|---|------|------|------|------|--|--|
| RXL | 150 Viper | 07 - | | T | | 1184 | ATV1 | | |
| VXL | 250 Vector, ST Vector | 06 - | 2 | 2469 | ATV1 | 1184 | ATV1 | | |
| VTX | 300 Vortex, ST Vortex | 07 - | 2 | 2469 | ATV1 | 1184 | ATV1 | | |
| VXL | 300 Vector, ST Vector | 07 - | 2 | 2469 | ATV1 | 1184 | ATV1 | | |



FACTORY

| | | | | | |
|-----------|------|---|------|------|-----|
| 50 Helix | 04 - | T | 2469 | ATV1 | X59 |
| 50 Rex | 04 - | T | 2469 | ATV1 | X59 |
| 100 Helix | 04 - | T | 2469 | ATV1 | X59 |
| 100 Rex | 04 - | T | 2469 | ATV1 | X59 |

GAS GAS

| | | | | | | | |
|-------------|------|---|------|------|------|------|-----|
| 50 Wild HP | 04 - | 2 | 2352 | ATV1 | 2352 | ATV1 | X59 |
| 200 Wild HP | 08 - | 2 | 2352 | ATV1 | 2352 | ATV1 | X59 |
| 240 Wild HP | 04 - | 2 | 2352 | ATV1 | 2352 | ATV1 | X59 |
| 250 Wild HP | 08 - | 2 | 2352 | ATV1 | 2352 | ATV1 | X59 |
| 300 Wild HP | 03 - | 2 | 2352 | ATV1 | 2352 | ATV1 | X59 |
| 450 Wild HP | 03 - | 2 | 2352 | ATV1 | 2352 | ATV1 | X59 |
| 515 Wild HP | 09 - | 2 | 2352 | ATV1 | 2352 | ATV1 | X59 |

GILERA

| | | | | | | | |
|-----------------|------|---|------|------|------|------|-----|
| 250 Oregon Quad | 07 - | 2 | 2284 | ATV1 | 1151 | ATV1 | X59 |
|-----------------|------|---|------|------|------|------|-----|

HERCULES

| | | | | | | | |
|---------|------|---|------|------|--|--|--|
| 280 ATV | 07 - | 2 | 1147 | ATV1 | | | |
| 300 ATV | 07 - | 2 | 1147 | ATV1 | | | |

HONDA

| | | | | | | | |
|-----------------------|---------|---|------|------|------|------|-----|
| ATC 200 X | 83 - 85 | 1 | 2328 | ATV1 | 2328 | ATV1 | X59 |
| ATC 250 R | 81 | 1 | 2408 | ATV1 | T | | |
| ATC 250 R | 82 - 84 | 1 | 2328 | ATV1 | 2328 | ATV1 | X59 |
| ATC 250 R | 85 - 86 | 1 | 1164 | ATV1 | 1164 | ATV1 | X59 |
| ATC 250 X | 85 | 1 | 1164 | ATV1 | 2328 | ATV1 | X59 |
| TRX 250 R Fourtrax | 86 - 89 | 2 | NA | ATV1 | 1164 | ATV1 | X59 |
| TRX 250 X Fourtrax | 87 | 2 | NA | ATV1 | 1164 | ATV1 | X59 |
| TRX 250 EX Sportrax | 01 - 08 | 2 | 2328 | ATV1 | T | | |
| TRX 250 X9 | 09 - | 2 | 2328 | ATV1 | T | | |
| ATC 300 X | 85 | 1 | 1164 | ATV1 | 2328 | ATV1 | X59 |
| TRX 300 EX Fourtrax | 93 - 08 | 2 | 2328 | ATV1 | 2328 | ATV1 | X59 |
| TRX 300 EX Sportrax | 01 - 08 | 2 | 2328 | ATV1 | 2328 | ATV1 | X59 |
| TRX 300 X9 | 09 - | 2 | 2328 | ATV1 | 2328 | ATV1 | X59 |
| TRX 400 EX Fourtrax | 99 - 08 | 2 | 2328 | ATV1 | 2328 | ATV1 | X59 |
| TRX 400 EX Sportrax | 01 - 08 | 2 | 2328 | ATV1 | 2328 | ATV1 | X59 |
| TRX 400 X9 | 09 - | 2 | 2328 | ATV1 | 2328 | ATV1 | X59 |
| TRX 420 FA / FPA | 09 - | 2 | 2328 | ATV1 | 1140 | ATV1 | X59 |
| TRX 420 FPE / FPM 4x4 | 09 - | 2 | 2328 | ATV1 | T | | |
| TRX 450 EX Sportrax | 01 - | 2 | 2328 | ATV1 | 2328 | ATV1 | X59 |
| TRX 450 R | 04 - | 2 | 2300 | ATV1 | 1140 | ATV1 | X59 |
| TRX 650 FA Rincon | 03 - 05 | | T | | 1140 | ATV1 | X59 |
| TRX 650 FGA Rincon | 04 - 05 | | T | | 1140 | ATV1 | X59 |
| TRX 680 FA6 Rincon | 06 - | | T | | 1140 | ATV1 | X59 |
| TRX 680 FGA6 Rincon | 06 - | | T | | 1140 | ATV1 | X59 |
| TRX 700 XX | 08 - | 2 | 2300 | ATV1 | NA | | |

HYOSUNG

| | | | | | | | |
|---------------|------|---|------|------|------|------|-----|
| TE 450 Rapier | 06 - | 2 | 2408 | ATV1 | 2328 | ATV1 | X59 |
|---------------|------|---|------|------|------|------|-----|

KAWASAKI

| | | | | | | | |
|---------------------------------|---------|-----|------|------|------|------|-----|
| KSF 250 A1-A17 Mojave | 87 - | 2 | 2799 | ATV1 | 2328 | ATV1 | X59 |
| KXF 250 A1 / A2 Tecate | 87 - 88 | 2 | 2799 | ATV1 | 2328 | ATV1 | X59 |
| KXT 250 A1 Tecate Trike | 84 - | | T | | 2469 | ATV1 | X59 |
| KXT 250 A2 / B1 Tecate Trike | 85 - 86 | 1 | 2306 | ATV1 | 2306 | ATV1 | X59 |
| KXT 250 B2 Tecate Trike | 85 - | 1 | 2799 | ATV1 | 2328 | ATV1 | X59 |
| KEF 300 A1-A6 Lakota | 95 - | 2 | 2799 | ATV1 | 2328 | ATV1 | X59 |
| KLF 300 B1-B13 Bayou | 88 - | 2 | 2306 | ATV1 | T | | |
| KLF 300 C1-C12 Bayou | 89 - 05 | L 1 | 2288 | ATV1 | T | | |
| KLF 300 C1-C12 Bayou | 90 - 05 | R 1 | 2326 | ATV1 | T | | |
| KVF 300 A1-A2 / B1-B2 Prairie | 99 - | 2 | 2408 | ATV1 | T | | |
| KVF 360 2x4 / 4x4 Prairie | 03 - 06 | 2 | 2408 | ATV1 | T | | |
| KFX 400 | 02 - | 2 | 2408 | ATV1 | 2328 | ATV1 | X59 |
| KLF 400 B1-B7 Bayou | 93 - 99 | L 1 | 2288 | ATV1 | T | | |
| KLF 400 B1-B7 Bayou | 93 - 99 | R 1 | 2326 | ATV1 | T | | |
| KVF 400 A1-A2 / B1 Prairie | 97 - 98 | 2 | 2408 | ATV1 | T | | |
| KVF 400 C1-C2 / D1-D2 Prairie | 99 - | 2 | 2408 | ATV1 | T | | |
| KFX 450 | 07 - | L 1 | 1142 | ATV1 | 2328 | ATV1 | X59 |
| KFX 450 | 07 - | R 1 | 1141 | ATV1 | | | |
| KVF 650 Brute Force 4X4 D/E | 05 - | L 1 | 1142 | ATV1 | T | | |
| KVF 650 Brute Force 4X4 D/E | 05 - | R 1 | 1141 | ATV1 | | | |
| KVF 650 Brute Force 4X4 i F/G/H | 07 - | L 1 | 2288 | ATV1 | T | | |
| KVF 650 Brute Force 4X4 i F/G/H | 07 - | R 1 | 2326 | ATV1 | | | |
| KVF 650 Prairie | 01 - 03 | L 1 | 1142 | ATV1 | T | | |
| KVF 650 Prairie | 01 - 03 | R 1 | 1141 | ATV1 | | | |
| KFX 700 V-Force | 04 - | L 1 | 1142 | ATV1 | T | | |
| KFX 700 V-Force | 04 - | R 1 | 1141 | ATV1 | | | |
| KSV 700 V-Force A1 | 04 - | L 1 | 1142 | ATV1 | T | | |

KAWASAKI

| | | | | | | | |
|---------------------------|------|-----|------|------|---|--|--|
| KSV 700 V-Force A1 | 04 - | R 1 | 1141 | ATV1 | | | |
| KVF 700 Prairie | 04 - | L 1 | 1142 | ATV1 | T | | |
| KVF 700 Prairie | 04 - | R 1 | 1141 | ATV1 | | | |
| KRF 750 Teryx 4x4 | 08 - | L 1 | 2288 | ATV1 | T | | |
| KRF 750 Teryx 4x4 | 08 - | R 1 | 2326 | ATV1 | | | |
| KVF 750 Brute Force 4X4 i | 04 - | L 1 | 2288 | ATV1 | T | | |
| KVF 750 Brute Force 4X4 i | 04 - | R 1 | 2326 | ATV1 | | | |

KTM

| | | | | | | | |
|-----------------|------|---|------|------|------|------|-----|
| SX / XC 450 ATV | 08 - | 2 | 1204 | ATV1 | 1205 | ATV1 | X59 |
| SX / XC 505 ATV | 08 - | 2 | 1204 | ATV1 | 1205 | ATV1 | X59 |
| SX / XC 525 ATV | 08 - | 2 | 1204 | ATV1 | 1205 | ATV1 | X59 |

KYMCO

| | | | | | | | |
|----------------|---------|---|------|------|------|------|-----|
| 50 MXer | 00 - 07 | | T | | 1123 | ATV1 | |
| 50 MXu | 05 - 10 | | T | | 1123 | ATV1 | |
| 90 Maxxer | 05 - 06 | | T | | 1123 | ATV1 | |
| 125 MXer | 02 - 07 | | T | | 1123 | ATV1 | |
| 150 MXer | 02 - 07 | | T | | 1123 | ATV1 | |
| 150 MXu | 05 - 10 | | T | | 1123 | ATV1 | |
| 250 KXR | 04 - 07 | 2 | 1147 | ATV1 | 1151 | ATV1 | X59 |
| 250 MXu | 04 - 09 | 2 | 1147 | ATV1 | 1151 | ATV1 | X59 |
| 250 Urban Quad | 06 - | 2 | 1147 | ATV1 | 1151 | ATV1 | X59 |
| 300 Maxxer | 06 - 10 | 2 | 1147 | ATV1 | 1151 | ATV1 | X59 |
| 300 MXu | 06 - | 2 | 1147 | ATV1 | 1147 | ATV1 | |
| 400 MXu | 08 - | 2 | 1171 | ATV1 | 1171 | ATV1 | X59 |
| 500 MXu | 05 - 09 | 2 | 1147 | ATV1 | 1147 | ATV1 | |
| 500 UXV 4x4 | 08 - | 2 | 1147 | ATV1 | 1147 | ATV1 | |

LAVERDA

| | | | | | | | |
|--------------------|------|---|------|------|------|------|--|
| 400 Quasar 4x4 | 04 - | 2 | 2926 | ATV1 | 2926 | ATV1 | |
| 500 Quasar 4x4 / C | 04 - | 2 | 2926 | ATV1 | 2926 | ATV1 | |

LONCIN

| | | | | | | | |
|--------|------|---|------|------|---|--|--|
| LX 110 | 02 - | 2 | 2326 | ATV1 | T | | |
| LX 125 | 02 - | 2 | 2326 | ATV1 | T | | |

MZ / MUZ

| | | | | | | | |
|---------|--|--|---|--|------|------|-----|
| 125 VRT | | | T | | 2326 | ATV1 | |
| 150 VRS | | | T | | 2469 | ATV1 | X59 |
| 175 VRT | | | T | | 2326 | ATV1 | |

PGO

| | | | | | | | |
|--------------|------|--|----|--|------|------|-----|
| 50 Bug Rider | 06 - | | NA | | 2408 | ATV1 | X59 |
| 50 X-Rider | 03 - | | T | | 2469 | ATV1 | X59 |
| 125 X-Rider | 03 - | | T | | 2469 | ATV1 | X59 |
| 150 Bugxter | 05 - | | NA | | 2408 | ATV1 | X59 |
| 150 X-Rider | 03 - | | T | | 2469 | ATV1 | X59 |

POLARIS

| | | | | | | | |
|----------------------|---------|---|------|------|------|------|-----|
| Trail Boss 2x4 / 4x4 | 88 - 89 | 2 | 2927 | ATV1 | 2924 | ATV1 | X59 |
| 200 Phoenix | 05 - 08 | 2 | 2469 | ATV1 | 2306 | ATV1 | X59 |
| 200 Sawtooth | 06 | 2 | 2469 | ATV1 | 2469 | ATV1 | X59 |
| 250 2x4 / 4x4 | 90 - 93 | 2 | 2927 | ATV1 | 2924 | ATV1 | X59 |
| 250 Big Boss 4x6 | 89 - 93 | 2 | 2927 | ATV1 | 2924 | ATV1 | X59 |
| 250 Trail Blazer | 90 - 98 | 2 | 2927 | ATV1 | 2924 | ATV1 | X59 |
| 250 Trail Blazer | 99 - 04 | 2 | 2927 | ATV1 | 2925 | ATV1 | |
| 250 Trail Blazer | 05 - 06 | 2 | 2927 | ATV1 | NA | | |
| 250 Trail Boss | 91 - 99 | 2 | 2927 | ATV1 | 2924 | ATV1 | X59 |
| 250 Xplorer 4x4 | 00 - | 2 | 2927 | ATV1 | 2925 | ATV1 | |
| 300 2x4 / 4x4 | 94 - 95 | 2 | 2927 | ATV1 | 2924 | ATV1 | X59 |
| 300 Big Boss 6x6 | 94 | 2 | 2927 | ATV1 | 2924 | ATV1 | X59 |
| 300 Hawkeye | 06 - | 2 | 1171 | ATV1 | 1171 | ATV1 | X59 |
| 300 Sportsman 4x4 | 08 - | 2 | 2927 | ATV1 | 2927 | ATV1 | X59 |
| 300 Xplorer 4x4 | 96 - 00 | 2 | 2927 | ATV1 | 2924 | ATV1 | X59 |
| 300 Xpress L | 96 - 97 | 2 | 2927 | ATV1 | 2924 | ATV1 | X59 |
| 325 Magnum 2x4 / 4x4 | 00 - 02 | 2 | 2927 | ATV1 | 2925 | ATV1 | |
| 325 Trail Boss | 00 - 02 | 2 | 2927 | ATV1 | 2925 | ATV1 | |
| 325 Xpedition | 00 - 01 | 2 | 2927 | ATV1 | 2925 | ATV1 | |
| 325 Xpedition | 02 - | 2 | 2927 | ATV1 | 1165 | ATV1 | X59 |
| 330 ATP 4x4 | 04 - 05 | 2 | 2927 | ATV1 | 2927 | ATV1 | X59 |
| 330 ATP | 06 - | 2 | 2927 | ATV1 | 1165 | ATV1 | X59 |
| 330 E Trail Blazer | 08 - | 2 | 2927 | ATV1 | 1165 | ATV1 | X59 |
| 330 Magnum 2X4 / 4X4 | 03 - 06 | 2 | 2927 | ATV1 | 1165 | ATV1 | X59 |
| 330 Trail Boss | 03 - 04 | 2 | 2927 | ATV1 | 2925 | ATV1 | |
| 330 Trail Boss | 05 - 10 | 2 | 2927 | ATV1 | NA | | |
| 335 Sportsman 4x4 | 99 - 00 | 2 | 2927 | ATV1 | 2925 | ATV1 | |
| 335 Worker 4x4 | 99 - 00 | 2 | 2927 | ATV1 | 2925 | ATV1 | |
| 350 Big Boss L | 93 | 2 | 2927 | ATV1 | 2924 | ATV1 | X59 |

1 - 2 - 4 = Nombre de jeux / Number of sets / Anzahl Sets Numero blister / Numero de juegos

L = Gauche / Left / Links / Sinistra / Izquierda

R = Droite / Right / Rechts / Destra / Derecha

NA = Non Attribué / Not Available / Nicht verfügbar / Non disponibile / No disponible

T = Tambour / Mechanical Drum / Strommel / Tamburo / Tambor



POLARIS



RACING

| | | | | | | | |
|--------------------------------|---------|---|------|------|------|------|-----|
| 350 L 2x4 / 4x4 | 90 | 2 | 2927 | ATV1 | 2924 | ATV1 | X59 |
| 350 L 4x4 | 93 | 2 | 2927 | ATV1 | 2924 | ATV1 | X59 |
| 350 Sportsman 4x4 | 93 | 2 | 2927 | ATV1 | 2924 | ATV1 | X59 |
| 350 Trail Boss L 2x4 / 4x4 | 91 - 93 | 2 | 2927 | ATV1 | 2924 | ATV1 | X59 |
| 400 Big Boss L | 94 - 97 | 2 | 2927 | ATV1 | 2924 | ATV1 | X59 |
| 400 L 2x4 | 94 - 95 | 2 | 2927 | ATV1 | 2924 | ATV1 | X59 |
| 400 L 4x4 | 94 | 2 | 2927 | ATV1 | 2924 | ATV1 | X59 |
| 400 Scrambler 2x4 / 4x4 | 00 - 02 | 2 | 2927 | ATV1 | 2925 | ATV1 | |
| 400 Scrambler 4x4 | 98 - 00 | 2 | 2927 | ATV1 | 2925 | ATV1 | |
| 400 Scrambler L 4x4 | 95 - 97 | 2 | 2927 | ATV1 | 2924 | ATV1 | X59 |
| 400 Sport L | 94 - 98 | 2 | 2927 | ATV1 | 2924 | ATV1 | X59 |
| 400 Sportsman | 01 - 02 | 2 | 2927 | ATV1 | 2925 | ATV1 | |
| 400 Sportsman L 4x4 | 94 - 97 | 2 | 2927 | ATV1 | 2924 | ATV1 | X59 |
| 400 Xplorer L 4x4 | 95 - 98 | 2 | 2927 | ATV1 | 2924 | ATV1 | X59 |
| 400 Xplorer L 2x4 / 4x4 | 99 - 02 | 2 | 2927 | ATV1 | 2925 | ATV1 | |
| 400 Xpress L | 96 - 97 | 2 | 2927 | ATV1 | 2924 | ATV1 | X59 |
| 425 Magnum 2x4 / 4x4 | 95 - 98 | 2 | 2927 | ATV1 | 2924 | ATV1 | X59 |
| 425 Magnum 6x6 | 96 - 97 | 2 | 2927 | ATV1 | 2924 | ATV1 | X59 |
| 425 Xpedition 4x4 | 00 - | 2 | 2927 | ATV1 | 2925 | ATV1 | |
| 450 Outlaw S | 08 | 2 | 1220 | ATV1 | 2927 | ATV1 | X59 |
| 450 Outlaw MXR | 09 - 10 | 2 | 1220 | ATV1 | 2927 | ATV1 | X59 |
| 450 Sportsman | 06 - | 2 | 2927 | ATV1 | 1165 | ATV1 | X59 |
| 455 Diesel 4x4 EBS | 99 - 00 | 2 | 2927 | ATV1 | 2925 | ATV1 | |
| 455 Diesel | 01 - | 2 | 2927 | ATV1 | 2925 | ATV1 | |
| 500 ATP HO | 04 - 05 | 2 | 2927 | ATV1 | 2927 | ATV1 | X59 |
| 500 Big Boss 6x6 | 98 - 99 | 2 | 2927 | ATV1 | 2924 | ATV1 | X59 |
| 500 Magnum 4x4 | 99 - 01 | 2 | 2927 | ATV1 | 2925 | ATV1 | |
| 500 Magnum 2X4 / 4x4 HDS | 02 - 03 | 2 | 2927 | ATV1 | 1165 | ATV1 | X59 |
| 500 Outlaw | 06 - 07 | 2 | 2927 | ATV1 | 2927 | ATV1 | X59 |
| 500 Predator | 03 - 05 | 2 | 2927 | ATV1 | 2927 | ATV1 | X59 |
| 500 Predator E | 06 - | 2 | 2927 | ATV1 | 1165 | ATV1 | X59 |
| 500 Ranger 6x6 | 00 - 02 | 2 | 2927 | ATV1 | 1165 | ATV1 | X59 |
| 500 Revolver | 06 - | 2 | 2927 | ATV1 | 2927 | ATV1 | X59 |
| 500 Scrambler 2x4 | 01 - 02 | 2 | 2927 | ATV1 | 2925 | ATV1 | |
| 500 Scrambler 2x4 | 07 - 08 | 2 | 2927 | ATV1 | 1165 | ATV1 | X59 |
| 500 E Scrambler 2x4 / 4x4 | 08 - | 2 | 2927 | ATV1 | 1165 | ATV1 | X59 |
| 500 Scrambler 4x4 | 97 | 2 | 2927 | ATV1 | 2924 | ATV1 | X59 |
| 500 Scrambler 4x4 | 98 - 04 | 2 | 2927 | ATV1 | 2925 | ATV1 | |
| 500 Scrambler 4x4 | 05 - 10 | 2 | 2927 | ATV1 | 1165 | ATV1 | X59 |
| 500 Sportsman 4x4 | 96 - 97 | 2 | 2927 | ATV1 | 2924 | ATV1 | X59 |
| 500 Sportsman 4x4 EBS/RSE | 98 - 02 | 2 | 2927 | ATV1 | 2925 | ATV1 | |
| 500 Sportsman 6x6 | 00 - 08 | 2 | 2927 | ATV1 | 1165 | ATV1 | X59 |
| 500 Sportsman Efi / HO | 03 - 08 | 2 | 2927 | ATV1 | 1165 | ATV1 | X59 |
| 500 Sportsman Touring | 08 - 10 | 2 | 2927 | ATV1 | 2927 | ATV1 | X59 |
| 500 Sportsman Efi Quad | 08 - 10 | 2 | 2927 | ATV1 | 1165 | ATV1 | X59 |
| 500 XP Sportsman | 09 | 2 | 1222 | ATV1 | 1222 | ATV1 | |
| 500 Sportsman X2 | 06 - 08 | 2 | 2927 | ATV1 | 1165 | ATV1 | X59 |
| 500 Sportsman X2 Efi | 07 - 09 | 2 | 2927 | ATV1 | 2927 | ATV1 | X59 |
| 500 Xplorer 4x4 | 97 | 2 | 2927 | ATV1 | 2924 | ATV1 | X59 |
| 525 Outlaw S | 08 - 10 | 2 | 1220 | ATV1 | 2927 | ATV1 | X59 |
| 525 Outlaw IRS | 08 - 10 | 2 | 1220 | ATV1 | 2927 | ATV1 | X59 |
| 550 XP Sportsman EPS | 09 - 10 | 2 | 1222 | ATV1 | 1222 | ATV1 | |
| 550 Sportsman X2 | 10 | 2 | 1222 | ATV1 | 1222 | ATV1 | |
| 600 Sportsman 4x4 | 03 - 05 | 2 | 2927 | ATV1 | 1165 | ATV1 | X59 |
| 700 Sportsman 4x4 | 02 - 06 | 2 | 2927 | ATV1 | 1165 | ATV1 | X59 |
| 700 Sportsman MV 700 | 05 - 06 | 2 | 2927 | ATV1 | 1165 | ATV1 | X59 |
| 700 Sportsman Efi | 07 - | 2 | 2927 | ATV1 | 1165 | ATV1 | X59 |
| 700 Sportsman X2 | 08 - | 2 | 2927 | ATV1 | 2927 | ATV1 | X59 |
| 800 RZR | 08 - | 2 | 2927 | ATV1 | 2927 | ATV1 | X59 |
| 800 Sportsman Efi | 05 - 07 | 2 | 2927 | ATV1 | 1165 | ATV1 | X59 |
| 800 Sportsman X2 Efi | 07 - 09 | 2 | 2927 | ATV1 | 2927 | ATV1 | X59 |
| 800 Sportsman Efi Int/HO | 07 - 10 | 2 | 2927 | ATV1 | 1165 | ATV1 | X59 |
| 800 Sportsman Touring / Efi | 08 - 09 | 2 | 2927 | ATV1 | 2927 | ATV1 | X59 |
| 800 Sportsman Efi 6x6 Big Boss | 09 - 10 | 2 | 2927 | ATV1 | 2927 | ATV1 | X59 |
| 850 XP Sportsman | 09 - 10 | 2 | 1222 | ATV1 | 1222 | ATV1 | |
| 850 XP ES Sportsman | 09 - 10 | 2 | 1222 | ATV1 | 1222 | ATV1 | |

SUZUKI

| | | | | | | | |
|-----------------------------|---------|-----|------|------|------|------|-----|
| LT 230 EH/EJ/EK/EL/EM/EN/EP | 86 - 93 | 2 | 2799 | ATV1 | 2328 | ATV1 | X59 |
| LT 230 SF / SG / SH / SJ | 85 - 88 | 2 | 2799 | ATV1 | 2328 | ATV1 | X59 |
| LT 250 RF / RG / RH | 85 - 87 | 2 | 2799 | ATV1 | 2328 | ATV1 | X59 |
| LT 250 RJ/RK/RL/RM/RN | 88 - 94 | 2 | 2799 | ATV1 | 2328 | ATV1 | X59 |
| LT 250 SK / SL | 89 - 90 | 2 | 2799 | ATV1 | 2328 | ATV1 | X59 |
| LT-F 250 Ozark | 02 - 10 | 2 | 2408 | ATV1 | T | | |
| LT-Z 250 Quad Sport | 04 - 10 | 2 | 2408 | ATV1 | T | | |
| LT-F 300 King Quad | 02 - | R 1 | 2326 | ATV1 | T | | |
| LT-F 300 King Quad | 02 - | L 1 | 2288 | ATV1 | T | | |
| KLT-A 400 King Quad | 08 - | R 1 | 2923 | ATV1 | T | | |
| KLT-A 400 King Quad | 08 - | L 1 | 1102 | ATV1 | T | | |

SUZUKI



RACING

| | | | | | | | |
|--------------------------------------|---------|-----|------|------|------|------|-----|
| KLT-F 400 King Quad | 08 - | R 1 | 2923 | ATV1 | T | | |
| KLT-F 400 King Quad | 08 - | L 1 | 1102 | ATV1 | T | | |
| LT-A 400 Eiger 2WD / 4WD | 02 - 07 | 2 | 2408 | ATV1 | T | | |
| LT-A 400 King Quad | 08 - | R 1 | 2923 | ATV1 | T | | |
| LT-A 400 King Quad | 08 - | L 1 | 1102 | ATV1 | T | | |
| LT-F 400 Eiger 2WD / 4WD | 02 - 07 | 2 | 2408 | ATV1 | T | | |
| LT-F 400 King Quad | 08 - | R 1 | 2923 | ATV1 | T | | |
| LT-F 400 King Quad | 08 - | L 1 | 1102 | ATV1 | T | | |
| LT-Z 400 Quad Sport | 03 - 10 | 2 | 2408 | ATV1 | 2328 | ATV1 | X59 |
| LT-A 450 King Quad | 07 - | R 1 | 2923 | ATV1 | T | | |
| LT-A 450 King Quad | 07 - | L 1 | 1102 | ATV1 | T | | |
| LT-R 450 Quad Racer | 06 - | L 1 | 2288 | ATV1 | 2328 | ATV1 | X59 |
| LT-R 450 Quad Racer | 06 - | R 1 | 2326 | ATV1 | | | |
| LT 500 RH / RJ / RK / RL | 87 - 90 | 2 | 2799 | ATV1 | 2328 | ATV1 | X59 |
| LT-A 500 FY1/FK1 Quadmaster | 00 - | L 1 | 2288 | ATV1 | T | | |
| LT-A 500 FY1/FK1 Quadmaster | 00 - | R 1 | 2326 | ATV1 | | | |
| LT-A 500 FK2 - FK7 Vinson | 02 - 07 | 2 | 2408 | ATV1 | 1102 | ATV1 | X59 |
| LT-A 500 XPLO | 10 - | L 1 | 2923 | ATV1 | NA | | |
| LT-A 500 XPLO | 10 - | R 1 | 1102 | ATV1 | NA | | |
| LT-F 500 FW/FX/FY2 Quadrunner | 98 - 02 | L 1 | 2288 | ATV1 | T | | |
| LT-F 500 FW/FX/FY2 Quadrunner | 98 - 02 | R 1 | 2326 | ATV1 | T | | |
| LT-F 500 FK3 - FK7 Vinson Quadrunner | 03 - 07 | 2 | 2408 | ATV1 | T | | |
| LT-A 650 FK2 Vinson | 02 - | 2 | 2408 | ATV1 | 1102 | ATV1 | X59 |
| LT-A 700 King Quad | 05 - 07 | L 1 | 2923 | ATV1 | | | |
| LT-A 700 King Quad | 05 - 07 | R 1 | 1102 | ATV1 | | | |
| LT-V 700 Quadrunner Twin Peaks | 04 - 05 | R 1 | 1141 | ATV1 | | | |
| LT-V 700 Quadrunner Twin Peaks | 04 - 05 | L 1 | 1142 | ATV1 | | | |
| LT-A 750 King Quad | 08 - 09 | L 1 | 2923 | ATV1 | NA | | |
| LT-A 750 King Quad | 08 - 09 | R 1 | 1102 | ATV1 | NA | | |
| LT-A 750 XPLO | 10 - | L 1 | 2923 | ATV1 | NA | | |
| LT-A 750 XPLO | 10 - | R 1 | 1102 | ATV1 | NA | | |

SYM

| | | | | | | | |
|-------------------|---------|---|------|------|------|------|--|
| 200 Trackrunner | 05 - 09 | 2 | 1147 | ATV1 | 1184 | ATV1 | |
| 250 Quadlander | 05 - 09 | 2 | 1147 | ATV1 | 1184 | ATV1 | |
| 300 Citymax | 06 - | 2 | 1147 | ATV1 | 1184 | ATV1 | |
| 300 Outlander / S | 07 - | 2 | 1147 | ATV1 | 1147 | ATV1 | |
| 300 Quadlander | 06 - | 2 | 1147 | ATV1 | 1147 | ATV1 | |
| 600 Quadraider | 06 - 07 | 2 | 2408 | ATV1 | 1147 | ATV1 | |
| 600 Quadraider | 08 - 09 | 2 | 1147 | ATV1 | 1147 | ATV1 | |
| 600 Quadraider LE | 10 - | 2 | 1147 | ATV1 | 1147 | ATV1 | |

TGB

| | | | | | | | |
|-----------------------|---------|---|------|------|------|------|-----|
| 50 Hornet | 04 - 05 | | T | | 2469 | ATV1 | X59 |
| 90 Hornet | 04 - 05 | | T | | 2469 | ATV1 | X59 |
| 250 Blade / Congo | 06 - 07 | 2 | 2306 | ATV1 | 2469 | ATV1 | X59 |
| 325 Blade 4x2 / LE | 07 - | 2 | 2306 | ATV1 | 2469 | ATV1 | X59 |
| 325 Target 4x2 | 09 - | 2 | 2469 | ATV1 | 2306 | ATV1 | X59 |
| 400 Avenger 4x2 / LE | 07 - 09 | 2 | 1147 | ATV1 | 1147 | ATV1 | |
| 400 Target 4x2 | 09 - | 2 | 2469 | ATV1 | 2306 | ATV1 | X59 |
| 425 Blade 4x4 | 07 - 09 | 2 | 1147 | ATV1 | 1147 | ATV1 | |
| 425 Blade 4x4 SE | 09 - | 2 | 1147 | ATV1 | 1147 | ATV1 | |
| 425 Target 4x2 | 09 - | 2 | 2469 | ATV1 | 2306 | ATV1 | X59 |
| 500 Avenger 4x2 R | 07 - 09 | 2 | 1147 | ATV1 | 1147 | ATV1 | |
| 500 Target 4x2 | 09 - | 2 | 2469 | ATV1 | 2306 | ATV1 | X59 |
| 525 Blade 4x4 SE | 09 - | 2 | 1147 | ATV1 | 1147 | ATV1 | |
| 525 Blade 4x4 SL | 09 - | 2 | 1147 | ATV1 | 2306 | ATV1 | X59 |
| 525 SE 4x4 | 09 - | 2 | 1147 | ATV1 | 2306 | ATV1 | X59 |
| 525 Target 4x4 | 09 - | 2 | 2469 | ATV1 | 2306 | ATV1 | X59 |
| 550 Blade 4x4 SE / SL | 09 - | 2 | 1147 | ATV1 | 2306 | ATV1 | X59 |

YAMAHA

| | | | | | | | |
|---------------------------|---------|-----|------|------|------|------|-----|
| YFS 200 R Blaster | 03 - 06 | 2 | 2408 | ATV1 | 2328 | ATV1 | X59 |
| YFM 250 AN Bruin | 05 - 06 | 2 | 2408 | ATV1 | T | | |
| YFM 250 Bear Tracker | 01 - 04 | 2 | 2408 | ATV1 | T | | |
| YFM 250 Big Bear | 07 - | 2 | 2408 | ATV1 | T | | |
| YFM 250 R Raptor | 08 - | L 1 | 1193 | ATV1 | 2328 | ATV1 | X59 |
| YFM 250 R Raptor | 08 - | R 1 | 1192 | ATV1 | | | |
| YTZ 250 TR1-Z N/S | 85 - 86 | 1 | 2284 | ATV1 | 2284 | ATV1 | X59 |
| YFM 300 Warrior | 89 | 2 | 2408 | ATV1 | 2328 | ATV1 | X59 |
| YFM 350 Big Bear | 99 | 2 | 2408 | ATV1 | T | | |
| YFM 350 Bruin 4x2 / 4x4 | 04 - 06 | 2 | 2408 | ATV1 | T | | |
| YFM 350 Wolverine 4x2 | 95 - 05 | 2 | 2408 | ATV1 | 2328 | ATV1 | X59 |
| YFM 350 Wolverine 4x2 | 06 - 09 | 2 | 2408 | ATV1 | T | | |
| YFM 350 R Raptor | 04 - 09 | 2 | 2328 | ATV1 | 2328 | ATV1 | X59 |
| YFM 350 Grizzly 4x2 / 4x4 | 07 - | 2 | 2408 | ATV1 | T | | |
| YFM 350 Warrior XT/XU | 87 - 88 | 2 | 2284 | ATV1 | 2328 | ATV1 | X59 |
| YFM 350 Warrior XW/XA-M | 89 - | 2 | 2408 | ATV1 | 2328 | ATV1 | X59 |
| YFM 350 XA - M Warrior | 92 - 04 | 2 | 2408 | ATV1 | 2328 | ATV1 | X59 |

1 - 2 - 4 = Nombre de jeux / Number of sets / Anzahl Sets Numero blister / Numero des juegos

L = Gauche / Left / Links / Sinistra / Izquierda

R = Droite / Right / Rechts / Destra / Derecha

NA = Non Attribué / Not Available / Nicht verfügbar / Non disponibile / No disponible

T = Tambour / Mechanical Drum / Strommel / Tamburo / Tambor



YAMAHA

RACING

| | | | | | | | |
|---------------------------------|---------|-----|------|------|------|------|-----|
| YFZ 350 Banshee (A-M) | 87 - 89 | 2 | 2284 | ATV1 | 2328 | ATV1 | X59 |
| YFZ 350 Banshee (T-W) | 90 - 09 | 2 | 2408 | ATV1 | 2328 | ATV1 | X59 |
| YFM 400 FAM / FAN kodiak | 00 - 01 | 2 | 2408 | ATV1 | 2923 | ATV1 | X59 |
| YFM 400 FWP Big Bear 4x4 | 02 | 2 | 2328 | ATV1 | T | | |
| YFM 400 FPR/FPS Big Bear | 03 - 04 | 2 | 2408 | ATV1 | T | | |
| YFM 400 Kodiak Auto FAR/FAS | 03 - 04 | 2 | 2408 | ATV1 | T | | |
| YFM 400 Kodiak AR (5VH3/4) | 03 | 2 | 2408 | ATV1 | T | | |
| YFM 400 FAT/FAV (Big Bear) | 05 - 06 | 2 | 2408 | ATV1 | 2923 | ATV1 | X59 |
| YFM 400 Grizzly FGW/FGX | 07 - 08 | 2 | 2408 | ATV1 | 2923 | ATV1 | X59 |
| YFM 450 Kodiak FAR/FAS (5ND3/4) | 03 - 04 | 2 | 2408 | ATV1 | 2923 | ATV1 | X59 |
| YFM 450 Kodiak FAT/FAHT/FAV | 05 - 06 | 2 | 2408 | ATV1 | 2923 | ATV1 | X59 |
| YFM 450 Grizzly EPS | 07 - | L 1 | 1193 | ATV1 | 1195 | ATV1 | |
| YFM 450 Grizzly EPS | 07 - | R 1 | 1192 | ATV1 | 1194 | ATV1 | |
| YFM 450 Wolverine FXV-FXZ | 06 - | 2 | 2408 | ATV1 | 2923 | ATV1 | X59 |
| YFZ 450 S / T / R | 04 - 05 | L 1 | 2288 | ATV1 | 2328 | ATV1 | X59 |
| YFZ 450 S / T / R | 04 - 05 | R 1 | 2326 | ATV1 | | | |
| YFZ 450 V / W / X | 06 - 08 | L 1 | 2288 | ATV1 | 1164 | ATV1 | X59 |
| YFZ 450 V / W / X | 06 - 08 | R 1 | 2326 | ATV1 | | | |
| YFZ 450 RY / RZ | 09 - | L 1 | 2288 | ATV1 | 1164 | ATV1 | X59 |
| YFZ 450 RY / RZ | 09 - | R 1 | 2326 | ATV1 | | | |
| YXR 450 Rhino | 06 - | L 1 | 2288 | ATV1 | 1102 | ATV1 | X59 |
| YXR 450 Rhino | 06 - | R 1 | 2326 | ATV1 | | | |
| YFM 550 Grizzly EPS | 07 - | L 1 | 1193 | ATV1 | 1195 | ATV1 | |
| YFM 550 Grizzly EPS | 07 - | R 1 | 1192 | ATV1 | 1194 | ATV1 | |
| YFM 600 Grizzly FWAK-FWAN | 98 - 01 | 2 | 2328 | ATV1 | T | | |
| YFM 600 Grizzly Hunting HM/HMC | 00 - | 2 | 2328 | ATV1 | T | | |
| YFM 660 Raptor RN-RT | 01 - 05 | 2 | 2408 | ATV1 | 2408 | ATV1 | X59 |
| YFM 660 Grizzly FR /FS/FT | 03 - 05 | 2 | 2408 | ATV1 | NA | | |
| YFM 660 Grizzly FWAP-FWAV | 02 - 08 | 2 | 2408 | ATV1 | NA | | |
| YXR 660 Rhino | 04 - 06 | L 1 | 2288 | ATV1 | 1102 | ATV1 | X59 |
| YXR 660 Rhino | 04 - 06 | R 1 | 2326 | ATV1 | | | |
| YFM 700 Grizzly EPS | 07 - | L 1 | 1193 | ATV1 | 1195 | ATV1 | |
| YFM 700 Grizzly EPS | 07 - | R 1 | 1192 | ATV1 | 1194 | ATV1 | |
| YFM 700 R Raptor | 06 - | L 1 | 2288 | ATV1 | 1102 | ATV1 | X59 |
| YFM 700 R Raptor | 06 - | R 1 | 2326 | ATV1 | | | |



Scooter

Scooter





ADLY

| | | | | | | |
|----------------------------|-------|---|------|----|------|----|
| 50 Panther | 01- | 1 | 3022 | SC | T | |
| 50 Silver Fox | 06- | 1 | 3022 | SC | T | |
| 50 Super Sonic | 00- | 2 | 3022 | SC | T | |
| 50 Thunderbike | 97- | 1 | 3022 | SC | T | |
| RS 50 Super Sonic | 06- | 1 | 3022 | SC | 3022 | SC |
| RT 100 Panther | 01- | 1 | 3022 | SC | T | |
| RT 100 Silver Fox | 06- | 1 | 3022 | SC | T | |
| RT 100 Super Sonic | 01- | 2 | 3022 | SC | T | |
| RT 100 Thunderbike | 01- | 2 | 3022 | SC | 3022 | SC |
| 25 Silver Fox | 00-05 | 1 | 3029 | SC | T | |
| 50 Cat | 01- | 1 | 3029 | SC | T | |
| 50 Cosy | 01- | 1 | 3029 | SC | T | |
| 50 Fox | 00- | 1 | 3029 | SC | T | |
| 50 Fox Plus | 01- | 1 | 3029 | SC | T | |
| 50 Jet | 96- | 1 | 3029 | SC | T | |
| 50 Pista, Pista Twin Light | 96- | 1 | 3029 | SC | T | |
| 50 Silver Fox | 00-05 | 1 | 3029 | SC | T | |
| RT 50 Road Tracer | 02- | 1 | 3029 | SC | T | |
| 70 Fox plus | 01- | 1 | 3029 | SC | T | |
| 70 Pista, Pista Twin Light | 01- | 1 | 3029 | SC | T | |
| 80 Cosy | 01- | 1 | 3029 | SC | T | |
| RT 90 Road Tracer | 02- | 1 | 3029 | SC | T | |
| 100 Cat | 01- | 1 | 3029 | SC | T | |
| 100 Jet | 96- | 1 | 3029 | SC | T | |
| 100 Silver Fox | 01-05 | 1 | 3029 | SC | T | |
| RT 100 Road Tracer | 02- | 1 | 3029 | SC | T | |

AEON

| | | | | | | |
|------------|-----|---|------|----|---|--|
| 50 Aero | 06- | 1 | 3022 | SC | T | |
| 50 Regal | 06- | 1 | 3022 | SC | T | |
| 50 Torch | 06- | 1 | 3022 | SC | T | |
| 90 Regal | 06- | 1 | 3022 | SC | T | |
| 100 Pulsar | 06- | 1 | 3022 | SC | T | |
| 110 Aero | 06- | 1 | 3022 | SC | T | |
| 110 Pulsar | 06- | 1 | 3022 | SC | T | |

APRILIA

| | | | | | | |
|-------------------------------|---------|---|------|----|------|----|
| AF-1 50 AE | 86 - | 1 | 3004 | SC | 3037 | SC |
| AF-1 50 Europa / Futura | 90 - | 1 | 3004 | SC | 3037 | SC |
| 50 Amico All models | 92 - | 1 | 3013 | SC | T | |
| 50 Area 51 | 98 - | 1 | 3013 | SC | 3013 | SC |
| 50 Business | 97 - | 1 | 3013 | SC | T | |
| 50 Classic | 96 - | 1 | 3013 | SC | T | |
| 50 Club | 97 - | 1 | 3013 | SC | T | |
| 50 Gulliver / Liquid | 95 - | 1 | 3013 | SC | T | |
| 50 Habana | 01 - | 1 | 3013 | SC | T | |
| 50 Mc Gulliver | 00 - | 1 | 3013 | SC | T | |
| 50 Mojito / Mojito Custom | 02 - | 1 | 3013 | SC | T | |
| 50 MX | 03 - | 1 | 3031 | SC | 3037 | SC |
| 50 Netscaper | 97 - | 1 | 3013 | SC | T | |
| 50 Racing | 98 - | 1 | 3013 | SC | 3013 | SC |
| 50 Rally | 95 - | 1 | 3013 | SC | T | |
| 50 Rally Liquid | 96 - | 1 | 3013 | SC | T | |
| 50 Red Rose | 90 - | 1 | 3004 | SC | T | |
| 50 Red Rose | 88 - 89 | 1 | 3034 | SC | T | |
| 50 RS | 93 - 95 | 1 | 3001 | SC | 3001 | SC |
| 50 RS | 96 - 99 | 1 | 3001 | SC | 3037 | SC |
| 50 RS / RS Replica | 00 - 05 | 1 | 3031 | SC | 3037 | SC |
| 50 RS | 06 - | 1 | 3057 | SC | 3015 | SC |
| 50 RS Tuono | 03 - | 1 | 3031 | SC | 3037 | SC |
| 50 RX | 06 - | 1 | 3069 | SC | 3015 | SC |
| 50 RX Racing | 04 - | 1 | 3031 | SC | 3037 | SC |
| 50 RX | 90 - | 1 | 3031 | SC | 3037 | SC |
| 50 Scarabéo | 94 - 99 | 1 | 3013 | SC | T | |
| 50 Scarabeo 4T | 04 - | 1 | 3064 | SC | T | |
| 50 Scarabeo Ditech | 02 - | 1 | 3013 | SC | 3055 | SC |
| 50 Scarabéo Street | 00 - | 1 | 3013 | SC | T | |
| 50 Sonic | 99 - | 1 | 3013 | SC | T | |
| 50 SR / SR Liquid | 93 - | 1 | 3013 | SC | T | |
| 50 SR Ditech / Racing | 00 - | 1 | 3013 | SC | 3055 | SC |
| 50 SR Stealth | 97 - | 1 | 3013 | SC | 3013 | SC |
| 50 SR Street | 05 - | 1 | 3013 | SC | 3055 | SC |
| 50 SR Replica | 94 - | 1 | 3053 | SC | T | |
| 50 SR Replica (Liquid Cooled) | 96 - | 1 | 3013 | SC | T | |
| 50 SR Urban Kid | 93 - | 1 | 3013 | SC | T | |
| 50 SR Viper | 93 - | 1 | 3013 | SC | T | |
| 50 SR WWW | 97 - | 1 | 3013 | SC | T | |
| 50 Tuareg | 86 - | 1 | 3004 | SC | 3037 | SC |
| 50 Tuareg Rally | 90 - | 1 | 3004 | SC | 3037 | SC |

APRILIA

| | | | | | | |
|------------------|------|---|------|----|---|--|
| 50 Younger | 97 - | 1 | 3013 | SC | T | |
| 100 Scarabeo | 00 - | 1 | 3064 | SC | T | |
| 100 Scarabeo 4T | 03 - | 1 | 3064 | SC | T | |
| 100 Scarabeo Net | 10 - | 1 | 3064 | SC | T | |

ATALA

| | | | | | | |
|--------------|------|---|------|----|---|--|
| 25 Carosello | 97 - | 1 | 3013 | SC | T | |
| AT10 50 Byte | 97 - | 1 | 3013 | SC | T | |
| 50 Carosello | 97 - | 1 | 3013 | SC | T | |
| 50 Hacker | 95 - | 1 | 3013 | SC | T | |
| 50 Skeggia | 98 - | 1 | 3013 | SC | T | |

BAOXIN

| | | | | | | |
|----------|------|---|------|-----|---|--|
| BX 125 L | 97 - | 1 | 3025 | MSC | T | |
|----------|------|---|------|-----|---|--|

BARIGO

| | | | | | | |
|------------------|------|---|------|----|---|--|
| Scooter Electric | 97 - | 1 | 3015 | SC | T | |
|------------------|------|---|------|----|---|--|

BENELLI

| | | | | | | |
|------------------------|---------|---|------|----|------|----|
| K2 50 Air / LC / Namur | 99 - | 1 | 3013 | SC | 3013 | SC |
| KB-X 50 Race | | 1 | 3029 | SC | T | |
| 50 491 | 98 - | 1 | 3013 | SC | T | |
| 50 491 RR / Superbike | 99 - | 1 | 3013 | SC | 3013 | SC |
| 50 491 ST | 01 - | 1 | 3013 | SC | T | |
| 50 Chrono | 92 - 93 | 1 | 3004 | SC | T | |
| 50 Chrono | 94 - | 1 | 3013 | SC | T | |
| 50 Naked | 02 - | 1 | 3013 | SC | T | |
| 50 Nemo / Quadra | 94 - | 1 | 3013 | SC | T | |
| 50 Pepe | 99 - | 1 | 3013 | SC | T | |
| K2 100 Biposto | 99 - | 1 | 3013 | SC | T | |
| LX 100 Pepe | 02 - | 1 | 3013 | SC | T | |
| 100 Naked | 02 - | 1 | 3013 | SC | T | |

BETA

| | | | | | | |
|-------------------|---------|---|------|----|------|----|
| RR 50 Enduro | 99 - | 1 | 3069 | SC | 3015 | SC |
| RR 50 Enduro | 10 - | 1 | 3069 | SC | NA | |
| RR 50 Enduro Alu | 04 - 07 | 1 | 3069 | SC | 3015 | SC |
| RR 50 Supermotard | 04 - 07 | 1 | 3015 | SC | 3015 | SC |
| RR 50 Motard Alu | 04 - | 1 | 3069 | SC | 3015 | SC |
| RR 50 Pro Race | 98 - | 1 | 3069 | SC | 3015 | SC |
| RR 50 Standard | 99 - | 1 | 3069 | SC | 3015 | SC |
| RR 50 Supermotard | 99 - 03 | 1 | 3069 | SC | 3015 | SC |
| 50 Ark | 96 - | 1 | 3013 | SC | 3013 | SC |
| 50 Ark LC Serie K | 98 - | 1 | 3013 | SC | 3013 | SC |
| 50 Chrono 13 | 94 - | 1 | 3013 | SC | T | |
| 50 Chrono 502 | 97 - | 1 | 3001 | SC | T | |
| 50 Eikon | 99 - 03 | 1 | 3015 | SC | 3015 | SC |
| 50 Eikon | 04 - | 1 | 3013 | SC | 3055 | SC |
| 50 Quadra | 94 - 96 | 1 | 3013 | SC | T | |
| 50 Quadra | 97 - | 1 | 3001 | SC | T | |
| 50 RK-6 | 96 - | 1 | 3013 | SC | 3013 | SC |
| 50 Techno | 96 - | 1 | 3015 | SC | 3015 | SC |
| 50 Tempo | 92 - 96 | 1 | 3015 | SC | T | |
| 50 Tempo | 97 - 98 | 1 | 3001 | SC | T | |
| 50 Tempo | 99 - | 1 | 3013 | SC | T | |

BUTALCO

| | | | | | | |
|-----------|------|---|------|----|------|----|
| 50 Astro | 01 - | 1 | 3069 | SC | 3015 | SC |
| 50 Lobito | 99 - | 1 | 3069 | SC | 3015 | SC |

CAGIVA

| | | | | | | |
|-------------|---------|---|------|----|---|--|
| 50 City | 92 - 94 | 1 | 3038 | SC | T | |
| 50 City | 95 - | 1 | 3039 | SC | T | |
| 50 City | 08 - | 1 | 3029 | SC | T | |
| 50 Corsa | 98 - | 1 | 3015 | SC | T | |
| 50 Cucciolo | 97 - | 1 | 3001 | SC | T | |
| 50 Mantis | 99 - | 1 | 3015 | SC | T | |
| 50 Nag | 08 - | 1 | 3047 | SC | T | |
| 50 Nuvola | 00 - | 1 | 3001 | SC | T | |
| 50 Progress | 98 - | 1 | 3015 | SC | T | |

CPI

| | | | | | | |
|--------------|---------|---|------|----|------|----|
| 50 GTR | 02 | 1 | 3031 | SC | | |
| 50 GTS | 02 | 1 | 3031 | SC | 3027 | SC |
| 50 GTR | 03 - | 1 | 3057 | SC | 3013 | SC |
| 50 Aragon GP | 06 - | 1 | 3047 | SC | T | |
| 50 Freaky | 07 - | 1 | 3047 | SC | T | |
| 50 Hussar | 01 - 02 | 1 | 3022 | SC | T | |
| 50 Hussar | 03 - | 1 | 3047 | SC | T | |



CPI

| | | | | | |
|------------|---------|---|------|----|---|
| 50 Mars | 01 - | 1 | 3022 | SC | T |
| 50 Olivier | 03 - | 1 | 3047 | SC | T |
| 50 Popcorn | 01 - 02 | 1 | 3022 | SC | T |
| 50 Popcorn | 03 - | 1 | 3047 | SC | T |

DAELIM

| | | | | | |
|---------------|---------|---|------|----|---|
| 50 A-Four | 06 - | 1 | 3078 | SC | T |
| 50 Besbi | 07 - | 1 | 3014 | SC | T |
| 50 Bonita | 09 - | 1 | 3038 | SC | T |
| 50 Cordi | 06 - | 1 | 3018 | SC | T |
| 50 Delfino | 99 - | 1 | 3018 | SC | T |
| 50 E-Five | 03 - | 1 | 3018 | SC | T |
| 50 History | 01 - | 1 | 3018 | SC | T |
| 50 G Message | 98 - | 1 | 3038 | SC | T |
| 50 Message II | 02 - | 1 | 3018 | SC | T |
| 50 S-Five | 01 - 05 | 1 | 3018 | SC | T |
| 50 S-Five | 06 - | 1 | 3038 | SC | T |
| 50 Tapo | 99 - | 1 | 3018 | SC | T |
| 50 Vivo | 99 - | 1 | 3018 | SC | T |
| 100 Delfino | 99 - | 1 | 3018 | SC | T |

DERBI

| | | | | | |
|-----------------------------|---------|---|------|----|---------|
| DS 50 | 88 | 1 | 3015 | SC | T |
| FDX 50 | 89 | 1 | 3015 | SC | T |
| GP 50 | 01 - | 1 | 3015 | SC | T |
| GP1 50 | 01 - 04 | 1 | 3015 | SC | 3015 SC |
| GP1 50 | 05 - | 1 | 3057 | SC | 3015 SC |
| GPR 50 Nude | 05 - | 1 | 3057 | SC | 3015 SC |
| GPR 50 Racing | 05 - | 1 | 3057 | SC | 3015 SC |
| GPR 50 R | 98 - 04 | 1 | 3069 | SC | 3015 SC |
| 50 Aceno | 98 - | 1 | 3015 | SC | T |
| 50 Atlantis | 99 - | 1 | 3015 | SC | T |
| 50 Atlantis 4T / Bullet | 04 - | 1 | 3015 | SC | T |
| 50 Atlantis H2O / Wave | 01 - | 1 | 3015 | SC | T |
| 50 Aventura | 95 - | 1 | 3015 | SC | T |
| 50 Black Devil | 04 - | 1 | 3031 | SC | 3015 SC |
| 50 DRD Pro Corse | 06 - | 1 | NA | NA | 3015 SC |
| 50 Easy | 96 - | 1 | 3015 | SC | T |
| 50 Fenix | 94 - | 1 | 3015 | SC | 3015 SC |
| 50 Furax | 95 - | 1 | 3015 | SC | 3015 SC |
| 50 Hunter | 97 - | 1 | 3015 | SC | T |
| 50 Manhattan | 99 - | 1 | 3015 | SC | T |
| 50 Paddock | 96 - | 1 | 3015 | SC | T |
| 50 Predator LC | 98 - | 1 | 3015 | SC | 3015 SC |
| 50 Predator O2 | 00 - | 1 | 3015 | SC | 3015 SC |
| 50 Rambla | 06 - | 1 | 3015 | SC | 3015 SC |
| 50 R DRD | 05 - | 1 | 3031 | SC | 3015 SC |
| 50 R Racer | 05 - | 1 | 3015 | SC | 3015 SC |
| 50 R X-Treme | 05 - | 1 | 3015 | SC | 3015 SC |
| 50 Savanah | 91 - | 1 | 3015 | SC | T |
| 50 Senda L | 99 - | 1 | 3015 | SC | 3015 SC |
| 50 Senda R / X-Treme | 94 - 04 | 1 | 3015 | SC | 3015 SC |
| 50 Senda R DRD | 03 - 04 | 1 | 3069 | SC | 3015 SC |
| 50 Senda SM / X-Treme | 99 - 04 | 1 | 3015 | SC | 3015 SC |
| 50 Senda SM DRD | 03 - 04 | 1 | 3015 | SC | 3015 SC |
| 50 Senda SM DRD Black Ed | 03 - | 1 | 3031 | SC | 3015 SC |
| 50 SM DRD / Racer | 05 - | 1 | 3031 | SC | 3015 SC |
| 50 SM X-Treme / X-Race | 05 - | 1 | 3031 | SC | 3015 SC |
| 50 Stinger | 96 - | 1 | 3015 | SC | T |
| 50 Urban | 94 - | 1 | 3015 | SC | T |
| 50 Vamos R (Brembo Caliper) | 95 - | 1 | 3013 | SC | T |
| 50 Vamos R / L / FL | 95 - | 1 | 3015 | SC | T |
| 50 Variant Sport R | 01 - | 1 | 3015 | SC | T |
| 100 Atlantis 4T | 04 - | 1 | 3015 | SC | T |
| 100 Atlantis O2 / H2O | 01 - | 1 | 3015 | SC | T |

FACTORY

| | | | | | |
|--------------|------|---|------|----|---------|
| RP 50 Desert | 04 - | 1 | 3031 | SC | 3015 SC |
| SM 50 Chrono | 04 - | 1 | 3031 | SC | 3015 SC |
| SP 50 Chrono | 04 - | 1 | 3031 | SC | 3015 SC |
| YR 50 Desert | 04 - | 1 | 3031 | SC | 3015 SC |

FANTIC

| | | | | | |
|--------------|------|---|------|----|---------|
| 50 Big Wheel | 94 - | 1 | 3029 | SC | 3012 SC |
| 50 Fast | | 1 | 3004 | SC | T |
| 50 Grinta | 95 - | 1 | 3029 | SC | 3012 SC |
| 50 Leader | 95 - | 1 | 3029 | SC | 3012 SC |
| 50 Oasis | 90 - | 1 | 3004 | SC | 3037 SC |
| 50 Pony SR | 93 - | 1 | 3029 | SC | T |

FANTIC

| | | | | | |
|--------------------|------|---|------|----|---------|
| 50 Queenie | 95 - | 1 | 3029 | SC | T |
| 50 Regolarina Casa | 08 - | 1 | 3031 | SC | 3022 SC |
| 50 Supersei Motard | 08 - | 1 | 3031 | SC | 3022 SC |

GARELLI

| | | | | | |
|--------------|------|---|------|----|---|
| CPR 50 | 02 - | 1 | 3029 | SC | T |
| FX 50 | 02 - | 1 | 3029 | SC | T |
| KRS 50 | 02 - | 1 | 3039 | SC | T |
| PMX 50 Rally | 00 - | 1 | 3029 | SC | T |
| PMX 50 Sport | 00 - | 1 | 3039 | SC | T |
| SR 50 Pony | 95 - | 1 | 3029 | SC | T |
| 50 Flo | 00 - | 1 | 3013 | SC | T |
| 50 Starter | 02 - | 1 | 3029 | SC | T |

GAS GAS

| | | | | | |
|--------------|---------|---|------|----|----|
| EC 50 Rookie | 05 - | 1 | 3031 | SC | NA |
| EC 50 Rookie | 01 - 04 | 1 | 3069 | SC | NA |
| SM 50 Rookie | 01 - | 1 | 3069 | SC | NA |

GENERIC

| | | | | | |
|---------------------------|------|---|------|----|---------|
| 50 Ideo | 06 - | 1 | 3047 | SC | T |
| 50 Roc | 08 - | 1 | 3047 | SC | |
| 50 Stroke | 08 - | 1 | 3047 | SC | |
| 50 Toxic | 07 - | 1 | 3031 | SC | 3013 SC |
| 50 Trigger SM | 06 - | 1 | 3031 | SC | 3013 SC |
| 50 Trigger SM Competition | 08 - | 1 | 3031 | SC | 3013 SC |
| 50 Trigger X | 06 - | 1 | 3031 | SC | 3013 SC |
| 50 Trigger X Competition | 08 - | 1 | 3031 | SC | 3013 SC |
| 50 XOR | 06 - | 1 | 3047 | SC | T |

GILERA

| | | | | | |
|---------------------------|---------|---|------|----|---------|
| DNA 50 (Grimeca Caliper) | 00 - | 1 | 3031 | SC | 3043 SC |
| DNA 50 (Hengtong Caliper) | 00 - | 1 | 3060 | SC | 3043 SC |
| GSM 50 Supermotard | 01 - | 1 | 3015 | SC | 3015 SC |
| NRG 50 | 94 - | 1 | 3013 | SC | T |
| R 50 | 96 - | 1 | 3034 | SC | |
| RCR 50 | 04 - | 1 | 3015 | SC | 3015 SC |
| SMT 50 | 04 - | 1 | 3015 | SC | 3015 SC |
| 50 503 | 91 - | 1 | 3034 | SC | 3034 SC |
| 50 Bullit | 90 - | 1 | 3034 | SC | T |
| 50 Eaglet | 97 - | 1 | 3013 | SC | 3022 SC |
| 50 Easy moving | 96 - | 1 | 3045 | SC | T |
| 50 H@k | 99 - | 1 | 3015 | SC | 3015 SC |
| 50 Ice | 02 - | 1 | 3013 | SC | T |
| 50 Runner | 97 | 1 | 3013 | SC | T |
| 50 Runner | 98 - 05 | 1 | 3013 | SC | 3043 SC |
| 50 Runner PJ | 06 - | 1 | 3031 | SC | 3043 SC |
| 50 Runner SP | 01 - 05 | 1 | 3013 | SC | 3043 SC |
| 50 Runner SP | 06 - | 1 | 3031 | SC | 3043 SC |
| 50 Stalker | 97 - | 1 | 3013 | SC | 3043 SC |
| 50 Storm | 94 - | 1 | 3013 | SC | T |
| 50 Typhoon | 93 - 95 | 1 | 3013 | SC | T |
| 50 Typhoon | 96 - | 1 | 3045 | SC | T |
| 50 Zulu | 01 - | 1 | 3015 | SC | 3015 SC |
| 70 Runner Malossi | 98 - | 1 | 3013 | SC | 3013 SC |
| 80 Typhoon | 95 - | 1 | 3013 | SC | T |

HERCULES

| | | | | | |
|------------------------------|------|---|------|----|---|
| 50 Gipsy / Splinter / Reggae | 95 - | 1 | 3013 | SC | T |
|------------------------------|------|---|------|----|---|

HERO ENVOY

| | | | | | |
|----|------|---|------|----|--|
| 50 | 99 - | 1 | 3015 | SC | |
|----|------|---|------|----|--|

HONDA

| | | | | | |
|--------------------------|---------|---|------|----|---|
| 50 Formula | 94 - | 1 | 3013 | SC | T |
| 50 Giorno | 92 - | 1 | 3038 | SC | T |
| 50 Jazz | 92 - | 1 | 3038 | SC | T |
| 50 Sky Classic | 00 - | 1 | 3013 | SC | T |
| 50 Sky Vetro | 00 - | 1 | 3013 | SC | T |
| 50 Tact S | 93 - | 1 | 3038 | SC | T |
| GP 50 Dio | 89 - | 1 | 3038 | SC | T |
| HSC 50 ZR / 01 Scooter | 92 | 1 | 3038 | SC | T |
| NH 50 Lead | 86 - 93 | 1 | 3009 | SC | T |
| NH 50 Lead | 94 - | 1 | 3014 | SC | T |
| SC 50 1-ZX | 92 - | 1 | 3018 | SC | T |
| SFX 50 Sport | 95 - 04 | 1 | 3013 | SC | T |
| SGX 50 Sky | 97 - 03 | 1 | 3013 | SC | T |
| SH 50 T / Fifty / Scoopy | 97 - 03 | 1 | 3013 | SC | T |
| SJ 50 Bali | 93 - 99 | 1 | 3020 | SC | T |

1 - 2 - 4 = Nombre de jeux / Number of sets / Anzahl Sets Numero blister / Numero des juegos

NA = Non Attribué / Not Available / Nicht verfügbar / Non disponibile / No disponible

T = Tambour / Mechanical Drum / Strommel / Tamburo / Tambor

Scooter



HONDA

| | | | | | |
|----------------------|---------|---|------|----|---------|
| SP 50 | - 91 | 1 | 3018 | SC | T |
| SP 50 | 92 - | 1 | 3038 | SC | T |
| SR 50 Super Dio | 91 - 92 | 1 | 3038 | SC | T |
| SR 50 Dio | 93 - | 1 | 3038 | SC | T |
| SRX 50 Shadow | 98 - | 1 | 3006 | SC | T |
| SXR 50 | 98 - | 1 | 3013 | SC | T |
| SZX 50 X8R-S / X8R-X | 98 - | 1 | 3013 | SC | 3041 SC |
| ZX 50 Super Dio | 92 - | 1 | 3038 | SC | T |
| 75 Yupy | 90 - | 1 | 3006 | SC | T |
| NH 80 Lead Scooter | 86 - | 1 | 3009 | SC | T |
| R 80 Lead | 88 - | 1 | 3009 | SC | T |
| NH 90 Yupy | 90 - 94 | 1 | 3014 | SC | T |
| SRX 90 Shadow | 98 - | 1 | 3006 | SC | T |
| 100 Lead | 00 - | 1 | 3019 | SC | T |
| EX 100 Bali | 96 - | 1 | 3020 | SC | T |
| SJ 100 Bali | 97 - | 1 | 3020 | SC | T |

HRD

| | | | | | |
|------------------------|---------|---|------|----|---------|
| 50 Sonic 2 Supermotard | 00 - 02 | 1 | 3069 | SC | 3015 SC |
| 50 Sonic 2 Trail | 00 - 02 | 1 | 3069 | SC | 3015 SC |

HUSQVARNA

| | | | | | |
|-------|------|---|------|----|---------|
| 50 SM | 02 - | 1 | 3069 | SC | 3015 SC |
| 50 WR | 02 - | 1 | 3069 | SC | 3015 SC |

HYOSUNG

| | | | | | |
|-------------------|------|---|------|----|---|
| SB 50 | 00 - | 1 | 3022 | SC | T |
| SD 50 | 00 - | 1 | 3022 | SC | T |
| SF 50 | 99 - | 1 | 3022 | SC | T |
| 50 Avanti | 99 - | 1 | 3022 | SC | T |
| 50 Rush | 97 - | 1 | 3022 | SC | T |
| 50 Sense | 98 - | 1 | 3022 | SC | T |
| 50 Super Cab | 95 - | 1 | 3022 | SC | T |
| 50 Super Cab Plus | 98 - | 1 | 3022 | SC | T |
| EZ 100 | 00 - | 1 | 3022 | SC | T |
| 100 Cab | 98 - | 1 | 3022 | SC | T |
| FX 110 | 02 - | 1 | 3022 | SC | T |
| KR 110 Master | 04 - | 1 | 3022 | SC | T |
| 110 Midas Plus | 98 - | 1 | 3022 | SC | T |

ITALJET

| | | | | | |
|-----------------|------|---|------|----|---------|
| SM 50 | 02 - | 1 | 3069 | SC | NA |
| 50 Bazooka | 93 - | 1 | 3029 | SC | T |
| 50 Cruise | 95 - | 1 | 3029 | SC | T |
| 50 Dragster | 99 - | 1 | 3015 | SC | 3015 SC |
| 50 Formula | 94 - | 1 | 3013 | SC | 3013 SC |
| 50 Formula Air | 99 - | 1 | 3015 | SC | 3015 SC |
| 50 Formula LC | 98 - | 1 | 3015 | SC | 3015 SC |
| 50 Formula Race | 95 - | 1 | 3015 | SC | 3015 SC |
| 50 Jet Set | 03 - | 1 | 3063 | SC | T |
| 50 Pista 2 | 93 - | 1 | 3029 | SC | T |
| 50 Rollercraft | 08 - | 1 | 3019 | SC | T |
| 50 Scoop | 93 - | 1 | 3029 | SC | T |
| 50 Torpedo | 97 - | 1 | 3015 | SC | T |
| 50 Torpedo 4T | 01 - | 1 | 3015 | SC | T |
| 50 Velocifero | 94 - | 1 | 3015 | SC | T |
| 50 Yankee 8 | 94 - | 1 | 3029 | SC | 3029 SC |
| SX1 50 | 08 - | 1 | 3047 | SC | T |
| 80 Formula | 94 - | 1 | 3013 | SC | 3013 SC |

JONWAY

| | | | | | |
|----------------------------|---------|---|------|----|---|
| YY 50 QT-6 Agility (2T/4T) | 07 - 09 | 1 | 3096 | SC | T |
| YY 50 QT-10 Viper (2T/4T) | 07 - 09 | 1 | 3096 | SC | T |
| YY 50 QT-28 Raptor (2T/4T) | 07 - 09 | 1 | 3096 | SC | T |
| YY 80 QT-6 Agility (4T) | 07 - 09 | 1 | 3096 | SC | T |

KEEWAY

| | | | | | |
|------------------------|---------|---|------|----|---------|
| 50 Focus | 06 - | 1 | 3047 | SC | T |
| 50 Matrix | 06 - | 1 | 3047 | SC | T |
| 50 Matrix Electric | 10 - | 1 | 3047 | SC | T |
| 50 Matrix Racing Sport | 10 - | 1 | 3047 | SC | T |
| F-NKD 50 | 10 - | 1 | 3047 | SC | T |
| RY8 50 | 07 - 09 | 1 | 3047 | SC | T |
| RY8 50 | 10 - | 1 | 3047 | SC | 3096 SC |
| TX 50 SM | 10 - | 1 | 3031 | SC | 3037 SC |
| 50 F-Act | 07 - | 1 | 3047 | SC | T |
| 50 Flash | 07 - | 1 | 3022 | SC | T |
| 50 Flash Electric | 10 - | 1 | 3047 | SC | T |
| 50 Hurricane | 06 - | 1 | 3022 | SC | T |

KEEWAY

| | | | | | |
|--------------|------|---|------|----|---|
| 90 Hurricane | 06 - | 1 | 3022 | SC | T |
| 100 Partner | 06 - | 1 | 3078 | SC | T |
| 110 Partner | 06 - | 1 | 3078 | SC | T |

KREIDLER

| | | | | | |
|---------------|------|---|------|----|---|
| 25 Florett XL | 99 - | 1 | 3022 | SC | T |
| 50 Florett | 99 - | 1 | 3022 | SC | T |

KTM

| | | | | | |
|-----------------------------|---------|---|------|----|---|
| 50 GO | 94 - | 1 | 3004 | SC | T |
| 50 Comet PL / TS / RLW / RS | 86 - 91 | 1 | 3013 | SC | T |

KYMCO

| | | | | | |
|-----------------------------|---------|---|------|----|---------|
| 50 Active SR | 08 - | 1 | 3096 | SC | T |
| 50 Agility | 05 - | 1 | 3078 | SC | T |
| 50 Agility (4T) RT10 / RT12 | 06 - | 1 | 3078 | SC | T |
| 50 Agility (4T) RT16 | 06 - | 1 | 3068 | SC | T |
| 50 B&W | 04 - | 1 | 3062 | SC | T |
| 50 Calypso | 97 - | 1 | 3047 | SC | T |
| 50 Cobra Cross | 99 - 00 | 1 | 3014 | SC | T |
| 50 Cobra Cross | 01 - | 1 | 3006 | SC | T |
| 50 Cobra Exclusive | 01 - | 1 | 3006 | SC | T |
| 50 Cobra Racer | 99 - 00 | 1 | 3014 | SC | T |
| 50 Cobra Racer | 01 - | 1 | 3006 | SC | T |
| 50 Dink / Dink Sport | 99 - | 1 | 3062 | SC | T |
| 50 Easy | 01 - | 1 | 3006 | SC | T |
| 50 Filly LX | 01 - | 1 | 3006 | SC | T |
| 50 Filly LX | 02 - | 1 | 3078 | SC | T |
| 50 Heroism | 95 - 96 | 1 | 3006 | SC | T |
| 50 Heroism | 97 - | 1 | 3047 | SC | T |
| 50 Heroism | 10 - | 1 | 3096 | SC | 3078 SC |
| 50 Manboy | 95 - | 1 | 3009 | SC | T |
| 50 New Dink | 08 - | 1 | 3062 | SC | T |
| 50 Nexxon | 08 - | 1 | 3096 | SC | 3096 SC |
| 50 People | 99 - | 1 | 3068 | SC | T |
| 50 Scout | 95 - | 1 | 3006 | SC | T |
| 50 Spacer | 99 - | 1 | 3062 | SC | T |
| 50 Super 8 | 08 - | 1 | 3068 | SC | T |
| 50 Super 9 | 00 - 01 | 1 | 3006 | SC | T |
| 50 Super 9 A/C | 02 - | 1 | 3062 | SC | T |
| 50 Super 9 L/C | 02 - | 1 | 3062 | SC | 3068 SC |
| 50 Top Boy On/Off Road | 96 - | 1 | 3006 | SC | T |
| 50 Top Boy Racer / Cross | 01 - | 1 | 3006 | SC | T |
| 50 Vitality | 04 - | 1 | 3078 | SC | T |
| 50 Yager | 01 - | 1 | 3062 | SC | T |
| 50 Yup | 01 - | 1 | 3006 | SC | T |
| 50 Yup | 02 - | 1 | 3078 | SC | T |
| 50 Zap | 95 - | 1 | 3009 | SC | T |
| 50 ZX12 | 06 - | 1 | 3014 | SC | T |
| CX 50 Curio Super | 94 - | 1 | 3006 | SC | T |
| DD 50 Sniper | 94 - | 1 | 3006 | SC | 3041 SC |
| K12 50 | 95 - | 1 | 3006 | SC | T |
| KB 50 | 95 - | 1 | 3006 | SC | T |
| ZX 50 Fever | 96 - | 1 | 3006 | SC | T |
| ZX 50 Super Fever | 02 - | 1 | 3006 | SC | T |
| RS 50 Agility Naked | 10 - | 1 | 3078 | SC | T |
| SP 90 Yup | 95 - | 1 | 3009 | SC | T |
| 90 Man Boy | 96 - | 1 | 3014 | SC | T |
| KB 100 | 99 - | 1 | 3006 | SC | T |
| 100 Cobra Racer | 99 - | 1 | 3062 | SC | T |
| 100 Spike | 00 - 06 | 1 | 3096 | SC | T |
| 100 Top Boy On/Off Road | 99 - | 1 | 3006 | SC | T |
| 110 Spike | 00 - 06 | 1 | 3096 | SC | T |

LEM

| | | | | | |
|----------|------|---|------|----|---|
| 50 Flash | 94 - | 1 | 3029 | SC | T |
|----------|------|---|------|----|---|

MACAL

| | | | | | |
|---------------|------|---|------|----|---|
| 50 Flash | 99 - | 1 | 3013 | SC | T |
| 50 Trophy | 99 - | 1 | 3015 | SC | T |
| 50 Trophy H2O | 99 - | 1 | 3015 | SC | T |

MAICO

| | | | | | |
|-----------------------|------|---|------|----|---|
| 50 Cruiser | 99 - | 1 | 3022 | SC | T |
| 50 Thunderbike I / II | 99 - | 1 | 3022 | SC | T |
| 50 Traffijammer | 99 - | 1 | 3022 | SC | T |
| R-1 50 Superbike | 99 - | 1 | 3022 | SC | T |



MALAGUTI

| | | | | | | |
|---------|--------------------------------|---------|---|------|----|---------|
| 50 | Centro | 93 - | 1 | 3004 | SC | T |
| 50 | Centro SL | 98 - | 1 | 3013 | SC | T |
| 50 | Ciak | 00 - | 1 | 3013 | SC | T |
| 50 | Ciak Twin Disk | 02 - | 1 | 3013 | SC | 3013 SC |
| 50 | Evolution | 91 - | 1 | 3037 | SC | T |
| ES | 50 Dune | 89 - | 1 | 3037 | SC | 3037 SC |
| 50 | Fifty Full / CX / Top | 85 - | 1 | 3034 | SC | T |
| 50 | Fifty Mistral | 90 - | 1 | 3034 | SC | T |
| 50 | Fifty | 04 - | 1 | 3031 | SC | 3015 SC |
| 50 | Yesterday | 97 - | 1 | 3013 | SC | T |
| CH | 50 | 86 - | 1 | 3031 | SC | T |
| CR | 150 Crosser | 95 - | 1 | 3034 | SC | T |
| EL | 50 Crosser | 97 - | 1 | 3013 | SC | T |
| F-10 | 50 Jet-Line | 94 - | 1 | 3013 | SC | T |
| F-10 | 50 Timemachine | 03 - | 1 | 3013 | SC | T |
| F-10 | 50 | 92 - 93 | 1 | 3024 | SC | T |
| F-10 | 50 WAP | 02 - | 1 | 3013 | SC | T |
| F-12 | 50 Phantom | 94 - 98 | 1 | 3034 | SC | T |
| F-12 | 50 Phantom (Liquid Cooled) | 94 - 98 | 1 | 3004 | SC | T |
| F-12 | 50 Phantom (Air cooled) | 99 - | 1 | 3013 | SC | T |
| F-12 | 50 Phantom (Liquid Cooled) | 99 - | 1 | 3013 | SC | 3013 SC |
| F-12 | 50 Phantom Digit | 02 - | 1 | 3013 | SC | 3013 SC |
| F-12 | 50 Racing Life LC / Tyre Track | 03 - | 1 | 3013 | SC | 3013 SC |
| F-15 | 50 Fire Fox | 96 - 99 | 1 | 3034 | SC | T |
| F-15 | 50 Fire Fox (Liquid Cooled) | 96 - 99 | 1 | 3004 | SC | T |
| F-15 | 50 Fire Fox | 01 - | 1 | 3013 | SC | T |
| F-15 | 50 Fire Fox LC | 01 - | 1 | 3013 | SC | 3013 SC |
| F-15 | 50 Mechatronic | 03 - | 1 | 3013 | SC | 3013 SC |
| NKD | 50 Drakon | 06 - | 1 | 3057 | SC | 3015 SC |
| RST | 50 Sport | 87 - | 1 | 3034 | SC | 3034 SC |
| XSM | 50 | 04 - | 1 | 3031 | SC | 3015 SC |
| XTM | 50 | 04 - | 1 | 3015 | SC | 3015 SC |
| 100 | Ciak | 00 - | 1 | 3013 | SC | 3013 SC |
| F-12100 | Phantom | 00 - | 1 | 3013 | SC | T |
| F-12100 | Phantom Twin Disk | 02 - | 1 | 3013 | SC | 3013 SC |

MH (MOTORHISPANIA)

| | | | | | | |
|-----|----------------|------|---|------|----|---------|
| MH | 50 Furia 6v | 99 - | 1 | 3015 | SC | 3015 SC |
| MH | 50 Furia Max | 06 - | 1 | 3015 | SC | 3015 SC |
| MH | 50 Urban Bike | 06 - | 1 | 3031 | SC | 3015 SC |
| RX | 50 Racing | 00 - | 1 | 3069 | SC | 3015 SC |
| RYZ | 50 Enduro | 05 - | 1 | 3015 | SC | 3015 SC |
| RYZ | 50 Supermotard | 05 - | 1 | 3069 | SC | 3015 SC |

MBK

| | | | | | | |
|-----|---------------------|---------|---|------|----|---------|
| 50 | Booster 12" | 03 - | 1 | 3013 | SC | T |
| 50 | Booster Naked | 04 - | 1 | 3013 | SC | T |
| 50 | Booster NG | 95 - | 1 | 3013 | SC | T |
| 50 | Booster Road | 94 - 95 | 1 | 3013 | SC | T |
| 50 | Booster Rocket | 96 - | 1 | 3013 | SC | T |
| 50 | Booster Spirit | 96 - | 1 | 3013 | SC | T |
| 50 | Booster Track | 96 - | 1 | 3013 | SC | T |
| 50 | Equalis | 95 - | 1 | 3013 | SC | T |
| 50 | Evolis | 92 - | 1 | 3013 | SC | T |
| 50 | Fizz | 94 - | 1 | 3013 | SC | T |
| 50 | Forte | 94 - 95 | 1 | 3013 | SC | T |
| 50 | Flipper | 98 - | 1 | 3013 | SC | T |
| 50 | Mach G | 03 - | 1 | 3013 | SC | T |
| 50 | Nitro | 97 - | 1 | 3013 | SC | 3027 SC |
| 50 | Ovetto | 97 - | 1 | 3013 | SC | T |
| 50 | Ovetto (4T) | 09 - | 1 | 3013 | SC | T |
| 50 | Stunt | 99 - | 1 | 3027 | SC | T |
| 50 | Target | 92 - | 1 | 3029 | SC | T |
| 50 | X-Limit | 98 - 03 | 1 | 3004 | SC | T |
| 50 | X-Limit | 04 - | 1 | 3015 | SC | 3063 SC |
| 50 | X-Limit Supermotard | 04 - | 1 | 3031 | SC | 3063 SC |
| 50 | X-Power | 98 - 03 | 1 | 3036 | SC | 3008 SC |
| 50 | X-Power | 04 - | 1 | 3031 | SC | 3015 SC |
| 80 | Evolis | 94 - | 1 | 3013 | SC | T |
| 100 | Booster | 01 - | 1 | 3008 | SC | T |
| 100 | Nitro | 01 - | 1 | 3013 | SC | 3027 SC |
| 100 | Ovetto | 01 - | 1 | 3013 | SC | T |

MOTRON

| | | | | | | |
|----|---------|------|---|------|----|---|
| 50 | Spike | 97 - | 1 | 3013 | SC | T |
| 50 | Sting | 95 - | 1 | 3013 | SC | T |
| 50 | Syncro | 97 - | 1 | 3013 | SC | T |
| 50 | Thunder | 95 - | 1 | 3013 | SC | T |

MZ / MUZ

| | | | | | | |
|----|-----------------|---------|---|------|----|---|
| 50 | Moskito | 99 - 02 | 1 | 3022 | SC | T |
| 50 | Moskito FB | 97 - 03 | 1 | 3029 | SC | T |
| 50 | Moskito SX JP50 | 00 - 03 | 1 | 3029 | SC | T |

PEUGEOT

| | | | | | | |
|-------------|-------------------------------------|---------|---|------|----|---------|
| AJP Caliper | | | | 3015 | SC | |
| SV | 50 Executive | 95 - | 1 | 3047 | SC | T |
| SV | 50 L | 93 - | 1 | 3006 | SC | T |
| SV | 50 Rolland Garros | 93 - | 1 | 3024 | SC | T |
| SV | 50 Geo | 91 - | 1 | 3006 | SC | T |
| SV | 50 T | 93 - | 1 | 3024 | SC | T |
| SV | 50 Sport | 93 - | 1 | 3024 | SC | T |
| XP | S650 Street / Super Motard | 04 - | 1 | 3031 | SC | 3015 SC |
| XP6 | 50 Enduro | 03 - 10 | 1 | 3015 | SC | 3015 SC |
| XP6 | 50 Supermotard | 03 - 09 | 1 | 3015 | SC | 3015 SC |
| XP6 | 50 Trail | 04 - 05 | 1 | 3015 | SC | 3015 SC |
| XPS | 50 Track / Enduro | 03 - 09 | 1 | 3015 | SC | 3015 SC |
| XPS | 50 Street / Top Road | 03 - 09 | 1 | 3031 | SC | 3015 SC |
| XPS | 50 Super Motard | 03 - 10 | 1 | 3031 | SC | 3015 SC |
| XPS | 50 SM | 09 - | 1 | NA | SC | NA SC |
| XR-6 | 50 | 02 - 07 | 1 | 3069 | SC | 3015 SC |
| XR-7 | 50 | 08 - | | NA | | NA SC |
| 50 | Buxy (AJP Caliper) | 94 - | 1 | 3015 | SC | T |
| 50 | Buxy (Brembo Caliper) | 94 - 97 | 1 | 3013 | SC | T |
| 50 | Buxy (Hengtong Caliper) | 94 - | 1 | 3022 | SC | T |
| 50 | Elyséo | 02 - | 1 | 3015 | SC | 3015 SC |
| 50 | Elyséo (AJP Caliper) | 98 - 01 | 1 | 3015 | SC | T |
| 50 | Elyseo (Hengtong Caliper) | 98 - | 1 | 3022 | SC | T |
| 50 | Elystar | 02 - 07 | 1 | 3015 | SC | 3063 SC |
| 50 | Elystar Advantage | 02 - 07 | 1 | 3015 | SC | 3015 SC |
| 50 | Jet C-Tech | 09 - | 1 | 3015 | SC | 3015 SC |
| 50 | Jet Force | 03 - | 1 | 3015 | SC | 3015 SC |
| 50 | Jet Force H2I | 11 - | 1 | 3015 | SC | 3015 SC |
| 50 | Kisbee (4T) | 10 - | 1 | 3022 | SC | T |
| 50 | Looxor | 02 - 05 | 1 | 3015 | SC | T |
| 50 | Looxor | 06 - | 1 | 3015 | SC | 3015 SC |
| 50 | Ludix (All models 10") | 04 - 09 | 1 | 3015 | SC | T |
| 50 | Ludix 2 Trend 12" | 07 - 10 | 1 | 3015 | SC | T |
| 50 | Ludix Blaster RCUP | 09 - | 1 | 3015 | SC | 3015 SC |
| 50 | Ludix Blaster RS12 | 09 - | 1 | 3015 | SC | T |
| 50 | Ludix Blaster Furious | 09 - | 1 | 3015 | SC | 3015 SC |
| 50 | Ludix Elegance 14" | 04 - 09 | 1 | 3015 | SC | T |
| 50 | Metal-X (All models) | 03 - 06 | 1 | 3015 | SC | T |
| 50 | Speedake (AJP Caliper) | 94 - | 1 | 3015 | SC | T |
| 50 | Speedake (Brembo Caliper) | 94 - 97 | 1 | 3013 | SC | T |
| 50 | Speedake (Hengtong Caliper) | 94 - | 1 | 3022 | SC | T |
| 50 | Speedfight LC (AJP Caliper) | 96 - 00 | 1 | 3015 | SC | T |
| 50 | Speedfight LC (Brembo Caliper) | 96 - 00 | 1 | 3013 | SC | T |
| 50 | Speedfight LC (Hengtong Caliper) | 96 - 00 | 1 | 3022 | SC | T |
| 50 | Speedfight 2 Air cooled | 01 - 08 | 1 | 3015 | SC | T |
| 50 | Speedfight 2 Liquid Cooled | 01 - 08 | 1 | 3015 | SC | 3015 SC |
| 50 | Speedfight 2 Furious/WRC/X-Race | 03 - 08 | 1 | 3015 | SC | 3015 SC |
| 50 | Speedfight 3 Air cooled | 09 - | 1 | 3096 | SC | T |
| 50 | Speedfight 3 Liquid Cooled | 09 - | 1 | 3096 | SC | 3057 SC |
| 50 | Speedfight 3 RS | 09 - | 1 | 3096 | SC | 3057 SC |
| 50 | Squab (AJP Caliper) | 94 - | 1 | 3015 | SC | T |
| 50 | Squab (Hengtong Caliper) | 94 - | 1 | 3022 | SC | T |
| 50 | TKR / TKR WRC | 05 - | 1 | 3015 | SC | T |
| 50 | TKR Street Zone / WRC | 03 - | 1 | 3015 | SC | T |
| 50 | Trekker Metal X | 01 - | 1 | 3015 | SC | T |
| 50 | Trekker Off Road (Hengtong Caliper) | 98 - | 1 | 3022 | SC | T |
| 50 | Trekker Road (AJP Caliper) | 98 - | 1 | 3015 | SC | T |
| 50 | Trekker Street Board | 00 - | 1 | 3015 | SC | T |
| 50 | Trekker Urban Black | 00 - | 1 | 3015 | SC | T |
| 50 | Tweet (4T) | 10 - | 1 | 3039 | SC | T |
| 50 | V-Clic (4T) | 08 - | 1 | 3029 | SC | |
| 50 | Vivacity (AJP Caliper) | 99 - 07 | 1 | 3015 | SC | T |
| 50 | Vivacity (Hengtong Caliper) | 05 - | 1 | 3022 | SC | T |
| 50 | New Vivacity 2T / 4T | 08 - 10 | 1 | 3047 | SC | T |
| 50 | Zenith Luxe | 94 - | 1 | 3013 | SC | T |
| 50 | Zenith (Grimeca Caliper) | 96 - | 1 | 3013 | SC | T |
| 50 | Zenith (Hengtong Caliper) | 96 - | 1 | 3022 | SC | T |
| 50 | Zenith LS | 96 - 99 | 1 | 3015 | SC | T |
| SV | 80 | 95 - | 1 | 3047 | SC | T |
| SV | 80 Geo | 91 - | 1 | 3006 | SC | T |
| SV | 100 | 91 - | 1 | 3006 | SC | T |
| 100 | Elyséo (AJP Caliper) | 98 - 01 | 1 | 3015 | SC | T |
| 100 | Elyséo | 02 - | 1 | 3015 | SC | 3015 SC |
| 100 | Looxor | 01 - 04 | 1 | 3015 | SC | 3015 SC |

1 - 2 - 4 = Nombre de jeux / Number of sets / Anzahl Sets / Numero blister / Numero des juegos

NA = Non Attribué / Not Available / Nicht verfügbar / Non disponibile / No disponible

T = Tambour / Mechanical Drum / Strommel / Tamburo / Tambor



PEUGEOT

| | | | | | | |
|-------------------------------------|---------|---|------|----|------|----|
| 100 Speedfight LCA (Brembo Caliper) | 97 - | 1 | 3013 | SC | T | |
| 100 Speedfight (AJP Caliper) | 97 - | 1 | 3015 | SC | 3015 | SC |
| 100 Speedfight (Hengtong Caliper) | 97 - | 1 | 3022 | SC | T | |
| 100 Speedfight 2 Furious/WRC/X-Race | 03 - | 1 | 3015 | SC | 3015 | SC |
| 100 Squab | 98 - | 1 | 3015 | SC | 3015 | SC |
| 100 Trekker Road | 98 - | 1 | 3015 | SC | T | |
| 100 Vivacity (AJP Caliper) | 99 - 07 | 1 | 3015 | SC | T | |
| 100 Vivacity (Hengtong Caliper) | 05 - | 1 | 3022 | SC | T | |

PGO

| | | | | | | |
|------------------|---------|---|------|----|---|--|
| PMX 50 | 98 - | 1 | 3029 | SC | T | |
| PMS 50 | 99 - | 1 | 3039 | SC | T | |
| PMX 50 Sport | 01 - | 1 | 3039 | SC | T | |
| PMX 50 Naked | 06 - | 1 | 3039 | SC | T | |
| PS 50 | 93 - | 1 | 3022 | SC | T | |
| 50 Big Max | 94 - 02 | 1 | 3029 | SC | T | |
| 50 Big Max | 03 - | 1 | 3022 | SC | T | |
| 50 Big Max Sport | 96 - | 1 | 3029 | SC | T | |
| 50 Comet | 93 - | 1 | 3029 | SC | T | |
| 50 Comet Sport | 91 - | 1 | 3022 | SC | T | |
| 50 Dr. Big | 01 - | 1 | 3039 | SC | T | |
| 50 EPS | 96 - | 1 | 3029 | SC | T | |
| 50 Galaxy | 91 - | 1 | 3022 | SC | T | |
| 50 G-max | 06 - | 1 | 3039 | SC | T | |
| 50 G-max Doppler | 06 - | 1 | 3013 | SC | T | |
| 50 Hot | 97 - | 1 | 3029 | SC | T | |
| 50 Libra | 10 - | 1 | 3039 | SC | T | |
| 50 Ligero | 06 - | 1 | 3039 | SC | T | |
| 50 Mega | 96 - | 1 | 3029 | SC | T | |
| 50 Road 66 | 95 - | 1 | 3022 | SC | T | |
| 50 Rodoshow | 01 - | 1 | 3013 | SC | T | |
| 50 Tornado | 96 - | 1 | 3029 | SC | T | |
| 50 T-Rex | 99 - | 1 | 3039 | SC | T | |
| 50 T-Rex 3 | 02 - | 1 | 3019 | SC | T | |
| 80 1.25 Big Max | 94 - | 1 | 3029 | SC | T | |
| 90 Big Max | 96 - | 1 | 3029 | SC | T | |
| 90 Galaxy | 92 - | 1 | 3022 | SC | T | |
| 90 Rodoshow | 02 - | 1 | 3013 | SC | T | |
| 90 Tornado | 00 - | 1 | 3029 | SC | T | |
| 100 Big Max | 94 - | 1 | 3029 | SC | T | |
| 100 My Bubú | 02 - | 1 | 3039 | SC | T | |
| PMX110 | 00 - | 1 | 3029 | SC | T | |
| 110 T-Rex | 99 - | 1 | 3039 | SC | T | |

PIAGGIO

| | | | | | | |
|----------------------|---------|---|------|----|------|----|
| 25 Zip II Cat DT | 01 - | 1 | 3045 | SC | T | |
| 50 Diesis | 02 - | 1 | 3015 | SC | T | |
| 50 Fly | 05 - | 1 | 3060 | SC | T | |
| 50 Free | 93 - 96 | 1 | 3045 | SC | T | |
| 50 Free | 97 - | 1 | 3013 | SC | T | |
| 50 Liberty | 97 - | 1 | 3043 | SC | T | |
| 50 Liberty 4T | 00 - | 1 | 3043 | SC | T | |
| 50 NTT | 95 - | 1 | 3013 | SC | T | |
| 50 Quartz | 92 - | 1 | 3053 | SC | T | |
| 50 Sfera RST | 95 - | 1 | 3045 | SC | T | |
| 50 Storm | 94 - 95 | 1 | 3013 | SC | T | |
| 50 Storm | 96 - | 1 | 3045 | SC | T | |
| 50 Typhoon | 93 - 95 | 1 | 3013 | SC | T | |
| 50 Typhoon | 96 - | 1 | 3045 | SC | T | |
| 50 Typhoon | 06 - | 1 | 3022 | SC | T | |
| 50 Typhoon Catalysed | 02 - | 1 | 3013 | SC | 3013 | SC |
| 50 Zip & Zip | 94 - | 1 | 3013 | SC | T | |
| 50 Zip Fast Rider | 93 - 95 | 1 | 3013 | SC | T | |
| 50 Zip Fast Rider | 96 - | 1 | 3043 | SC | T | |
| 50 Zip RST | 96 - 99 | 1 | 3043 | SC | T | |
| 50 Zip SP / Disco | 96 - | 1 | 3043 | SC | T | |
| 50 Zip II | 01 - | 1 | 3045 | SC | T | |
| 50 Zip II Cat DT | 01 - | 1 | 3045 | SC | T | |
| ET2 50 | 97 - 01 | 1 | 3043 | SC | T | |
| ET2 50 | 02 - | 1 | 3043 | SC | T | |
| ET4 50 | 00 - | 1 | 3043 | SC | T | |
| LX 50 2T / 4T | 05 - | 1 | 3043 | SC | T | |
| LXV 50 | 08 - | 1 | 3013 | SC | T | |
| NRG.150 | 94 - 95 | 1 | 3013 | SC | T | |
| NRG 50 | 96 - 00 | 1 | 3013 | SC | T | |
| NRG 50 Extreme | 01 - | 1 | 3013 | SC | 3043 | SC |
| NRG 50 MC 2 | 96 - 97 | 1 | 3013 | SC | T | |
| NRG 50 MC 2 | 98 - 02 | 1 | 3013 | SC | 3043 | SC |
| NRG 50 MC 3 DD / DT | 02 - | 1 | 3013 | SC | 3013 | SC |

PIAGGIO

| | | | | | | |
|----------------------|---------|---|------|----|------|----|
| NRG 50 Power DD | 05 | 1 | 3013 | SC | 3013 | SC |
| NRG 50 Power DD | 06 - | 1 | 3022 | SC | 3013 | SC |
| NRG 50 Purejet | 05 | 1 | 3013 | SC | 3013 | SC |
| NRG 50 Purejet | 06 - | 1 | 3022 | SC | 3013 | SC |
| NRG 50 Silver Bullet | 10 | 1 | 3022 | SC | 3013 | SC |
| NTT 50 | 96 - | 1 | 3045 | SC | T | |
| S 50 2T | 07 - | 1 | 3043 | SC | T | |
| S 50 4T | 09 - | 1 | 3043 | SC | T | |
| TPH 50 | 93 - 95 | 1 | 3013 | SC | T | |
| TPH 50 | 96 - | 1 | 3045 | SC | T | |
| 80 Skipper | 93 - 95 | 1 | 3053 | SC | T | |
| 80 Skipper | 96 - | 1 | 3045 | SC | T | |
| 80 Typhoon | 96 - | 1 | 3045 | SC | T | |
| 100 Diesis | 02 - | 1 | 3015 | SC | T | |
| 100 Free | 02 - | 1 | 3013 | SC | T | |
| 100 Zip | 07 - | 1 | 3060 | SC | T | |

QUINGOI

| | | | | | | |
|-----------|------|---|------|-----|---|--|
| QM 125 2V | 02 - | 1 | 3025 | MSC | T | |
| QM 125 GY | 02 - | 1 | 3087 | MSC | T | |

RIEJU

| | | | | | | |
|-------------------------------------------------------|---------|---|------|-----|------|----|
| 50 FD4 Super Marathon | 85 | 1 | 3015 | SC | T | |
| 50 First / H2O | 97 - | 1 | 3015 | SC | T | |
| MRT 50 (Single Piston Caliper) | 09 - 10 | 1 | 3012 | SC | 3012 | SC |
| MRT 50 Pro (Radial / Double Piston Caliper) | 09 - 10 | 1 | 3057 | SC | 3012 | SC |
| MRT 50 Supermotard (Cast Wheel/Single Piston Caliper) | 09 - 10 | 1 | 3012 | SC | 3012 | SC |
| MRT 50 Supermotard (Radial Caliper/Cast Wheel) | 09 - 10 | 1 | 3057 | SC | 3012 | SC |
| MRX 50 Castrol | 01 - 02 | 1 | 3069 | SC | 3015 | SC |
| MRX 50 | 03 - 08 | 1 | 3015 | SC | 3015 | SC |
| MRX 50 Pro / Top | 04 - 08 | 1 | 3031 | SC | 3015 | SC |
| RR 50 Thunderfire | 97 - 02 | 1 | 3015 | SC | 3015 | SC |
| RR 50 Castrol | 00 - 02 | 1 | 3069 | SC | 3015 | SC |
| RR 50 Sport | 03 - 06 | 1 | 3015 | SC | 3015 | SC |
| RRX 50 Spike (17" wheel / Spoke Wheel) | 03 - 08 | 1 | 3015 | SC | 3015 | SC |
| RRX 50 Spike (17" Cast wheel) | 06 - 09 | 1 | 3015 | SC | 3015 | SC |
| RRX 50 | 06 - 09 | 1 | 3015 | SC | 3015 | SC |
| RS1 50 | 97 - 00 | 1 | 3015 | SC | 3015 | SC |
| RS1 50 | 01 - | 1 | 3069 | SC | 3015 | SC |
| RS2 50 FR | 09 - 10 | 1 | 3080 | MSC | 3012 | SC |
| RS2 50 Matrix (AJP Caliper) | 02 - 08 | 1 | 3081 | SC | 3015 | SC |
| RS2 50 Matrix (J.Juan Caliper) | 07 - 09 | 1 | 3080 | MSC | 3015 | SC |
| RS2 50 Pro (J.Juan Caliper) | 07 - 10 | 1 | 3080 | MSC | 3015 | SC |
| RS2 50 Pro (AJP Caliper) | 06 - 10 | 1 | 3031 | SC | 3015 | SC |
| RS2 50 NKD | 05 | 1 | 3031 | SC | 3015 | SC |
| 50 NKD | 07 | 1 | 3081 | SC | 3015 | SC |
| 50 NKD | 08 - 10 | 1 | 3080 | SC | 3012 | SC |
| 50 Pacific (4T) | 08 | 1 | 3047 | SC | T | |
| SMX 50 | 02 - 06 | 1 | 3015 | SC | 3015 | SC |
| SMX 50 Pro Supermotard / Top | 04 - 07 | 1 | 3031 | SC | 3015 | SC |
| SMX 50 Pro Street (Cast Wheel) | 06 - 08 | 1 | 3031 | SC | 3015 | SC |
| SMX 50 (Cast Wheel) | 07 - 08 | 1 | 3015 | SC | 3015 | SC |
| 50 Spike | 04 - 06 | 1 | 3015 | SC | 3015 | SC |
| 50 Spike pro | 04 | 1 | 3069 | SC | 3015 | SC |
| 50 Spike X50 | 06 - 07 | 1 | 3015 | SC | 3015 | SC |
| 50 Tango | 07 - 10 | 1 | 3057 | SC | 3015 | SC |
| 50 Tango Motard | 09 - 10 | 1 | 3012 | SC | 3015 | SC |
| 50 Tereo (4T) | 07 - 08 | 1 | 3047 | SC | T | |
| 75 K6 / P6 | 87 | 1 | 3015 | SC | T | |
| RST 80 | 91 - | 1 | 3015 | SC | 3015 | SC |

ROXON

| | | | | | | |
|------------|------|---|------|----|------|----|
| 50 DUEL SM | 06 - | 1 | 3015 | SC | 3015 | SC |
| 50 DUEL TT | 06 - | 1 | 3015 | SC | 3015 | SC |

SACHS

| | | | | | | |
|----------------------|---------|---|------|----|------|----|
| 50 Bee | 08 - 10 | 1 | 3008 | SC | T | |
| 50 Madass (2 stroke) | 04 - 05 | 1 | 3096 | SC | 3015 | SC |
| 50 Madass (4 stroke) | 04 - 05 | 1 | 3096 | SC | 3015 | SC |
| 50 Madass (4T) | 06 - 09 | 1 | 3096 | SC | 3018 | SC |
| 50 Speedforce | 08 | 1 | 3047 | SC | T | |
| 50 Speedjet | 08 | 1 | 3047 | SC | T | |
| 50 49ER 12 | 08 | 1 | 3047 | SC | T | |
| 50 SX-1 (2T) | 08 - 09 | 1 | 3047 | SC | T | |

SHE-LUNG

| | | | | | | |
|-----------|------|---|------|----|---|--|
| 50 Falcon | 97 - | 1 | 3029 | SC | T | |
| 50 Racer | 96 - | 1 | 3013 | SC | T | |



SHERCO

| | | | | | | | |
|----|----------------------------------------------|---------|---|------|----|------|----|
| 50 | Enduro (2T) | 02 - 07 | 1 | 3069 | SC | 3015 | SC |
| 50 | Enduro (2T) / Urban / SU (Spoke wheel model) | 08 - 10 | 1 | 3069 | SC | 3063 | SC |
| 50 | Supermotard (2T) | 02 - 07 | 1 | 3069 | SC | 3015 | SC |
| 50 | SU (2T) Urban Base (Cast wheel model) | 10 - | 1 | 3012 | SC | 3063 | SC |
| 50 | SM 0.5 Black Panther | 08 - 10 | 1 | 3031 | SC | 3063 | SC |

SUZUKI

| | | | | | | | |
|---------|------------------------------------|---------|---|------|----|------|----|
| AH 50 | N Address (CA1GA) Italian Market | 92 - 95 | 1 | 3022 | SC | T | |
| AJ 50 | ZZ Sepia | 92 - | 1 | 3022 | SC | T | |
| AN 50 | | 95 | 1 | 3051 | SC | T | |
| AP 50 | R / S / T / V / W | 96 - 02 | 1 | 3013 | SC | T | |
| AY 50 | V/W/V/W/W/R/W/K1-K4 Katana | 97 - 04 | 1 | 3013 | SC | T | |
| AY 50 | WRK2-WRK4 Katana (Grimeca Caliper) | 99 - 04 | 1 | 3013 | SC | 3015 | SC |
| AY 50 | WRK1-WRK5 Katana (AJP Caliper) | 01 - 05 | 1 | 3015 | SC | 3015 | SC |
| AZ 50 | RY / RK2 | 00 - 02 | 1 | 3051 | SC | T | |
| CC 50 | Tune | 92 - | 1 | 3022 | SC | T | |
| DR 50 | Big | 89 - | 1 | 3015 | SC | T | |
| RMX 50 | | 98 - | 1 | 3015 | SC | 3015 | SC |
| SMX 50 | Super Motard | 98 - | 1 | 3015 | SC | 3015 | SC |
| TR 50 | Street Magic | 98 - | 1 | 3051 | SC | T | |
| TV 50 | Wolf | 89 - | 1 | 3012 | SC | T | |
| UF 50 | Estilite | 00 - 02 | 1 | 3015 | SC | T | |
| UX 50 | W Zillion | 99 - 02 | 1 | 3013 | SC | T | |
| ZZ 50 | Scooter | 92 - | 1 | 3022 | SC | T | |
| LIDO 75 | Style | 84 - | 1 | 3022 | SC | T | |
| AH 80 | Address | 88 - | 1 | 3022 | SC | T | |
| AH 80 | Scooter | 92 - 94 | 1 | 3022 | SC | T | |
| AJ 80 | ZZ Sepia | 90 - | 1 | 3022 | SC | T | |
| AH 100 | Address | 91 - 96 | 1 | 3022 | SC | T | |
| UG 110 | W/SW/Y/SY/SK1 Hokuto/Address | 98 - 02 | 1 | 3051 | SC | T | |
| FD 112 | Shogun R | 04 - | 1 | 3062 | SC | T | |

SIMSON

| | | | | | | | |
|----|------------|------|---|------|----|---|--|
| 50 | Habitat CX | 01 - | 1 | 3013 | SC | T | |
| 50 | Spatz | 99 - | 1 | 3013 | SC | T | |
| 50 | Sperber | 99 - | 1 | 3013 | SC | T | |
| 50 | Star | 99 - | 1 | 3013 | SC | T | |

SIAM

| | | | | | | | |
|-----|--------|------|---|------|----|---|--|
| 50 | Falcon | 97 - | 1 | 3013 | SC | T | |
| 50 | Mat | 97 - | 1 | 3022 | SC | T | |
| 50 | Scross | 97 - | 1 | 3013 | SC | T | |
| 100 | Mat | 97 - | 1 | 3022 | SC | T | |

SIAMOTO

| | | | | | | | |
|----|--------|------|---|------|----|---|--|
| 50 | Birdie | 02 - | 1 | 3029 | SC | T | |
|----|--------|------|---|------|----|---|--|

SULA

| | | | | | | | |
|-----|--------------|------|---|------|----|---|--|
| 50 | City Bird | 99 - | 1 | 3024 | SC | T | |
| 50 | Thunder Bird | 99 - | 1 | 3022 | SC | T | |
| 100 | Thunder Bird | 99 - | 1 | 3022 | SC | T | |

SYM

| | | | | | | | |
|--------|----------------|---------|---|------|----|------|----|
| 50 | Bullet | 93 | 1 | 3009 | SC | T | |
| 50 | Cinderella | 99 - | 1 | 3009 | SC | T | |
| 50 | City Hopper | 99 - 02 | 1 | 3038 | SC | T | |
| 50 | Fiddle II | 08 - 10 | 1 | 3039 | SC | T | |
| 50 | Jet Alpha | 95 - | 1 | 3039 | SC | T | |
| 50 | Jet Basix | 06 - 09 | 1 | 3039 | SC | T | |
| 50 | Jet Euro X S | 99 - 05 | 1 | 3039 | SC | T | |
| 50 | Jet Euro X | 06 - | 1 | 3039 | SC | T | |
| 50 | Jet Sport X SR | 06 - | 1 | 3039 | SC | 3041 | SC |
| 50 | Jet 4 (4T) | 10 - | 1 | 3039 | SC | T | |
| 50 | Jungle | 96 - | 1 | 3039 | SC | T | |
| 50 | Mask / Mask LC | 00 - 05 | 1 | 3039 | SC | T | |
| 50 | Mio | 05 - | 1 | 3009 | SC | T | |
| 50 | Orbit | 08 - 09 | 1 | 3038 | SC | T | |
| 50 | Red Devil | 99 - 09 | 1 | 3039 | SC | T | |
| 50 | Shark | 99 - 03 | 1 | 3067 | SC | T | |
| 50 | Super Fancy | 95 - 97 | 1 | 3039 | SC | T | |
| 50 | Super Fancy | 98 - | 1 | 3038 | SC | T | |
| 50 | Symphony (4T) | 09 - | 1 | 3039 | SC | T | |
| 50 | Symply | 07 - | 1 | 3039 | SC | T | |
| DD 50 | | 02 - | 1 | 3009 | SC | T | |
| RS 50 | | 04 - 09 | 1 | 3067 | SC | T | |
| RS2150 | | 02 - | 1 | 3067 | SC | T | |
| 100 | Cinderella | 01 - | 1 | 3009 | SC | T | |
| 100 | Jet | 99 - 00 | 1 | 3039 | SC | T | |
| 100 | Jet Euro X | 05 - | 1 | 3039 | SC | T | |

SYM

| | | | | | | | |
|--------|-------------|------|---|------|----|---|--|
| 100 | Jet Sport X | 06 - | 1 | 3039 | SC | T | |
| 100 | Mio | 05 - | 1 | 3009 | SC | T | |
| 100 | Party | 97 - | 1 | 3039 | SC | T | |
| SR 100 | Sunrise | 97 - | 1 | 3006 | SC | T | |
| 100 | Super Fancy | 95 - | 1 | 3039 | SC | T | |
| 110 | Bullet | 93 | 1 | 3009 | SC | T | |
| 110 | Star | 03 - | 1 | 3039 | SC | T | |

TGB

| | | | | | | | |
|----|-----------------------------------------|---------|---|------|----|------|----|
| 50 | Akros Tec | 03 - 04 | 1 | 3039 | SC | T | |
| 50 | Apollo | 99 - | 1 | 3078 | SC | T | |
| 50 | City (2T) / City (4T) | 07 - | 1 | 3022 | SC | T | |
| 50 | Delivery (Up to E/F no 609099) | 04 - 06 | 1 | 3039 | SC | T | |
| 50 | Delivery / Express (From E/F no 609100) | 06 - 09 | 1 | 3022 | SC | T | |
| 50 | Fire.Sky | 03 - | 1 | 3078 | SC | T | |
| 50 | Generic Trigger | 02 - | 1 | 3022 | SC | T | |
| 50 | High Wheel | 02 - | 1 | 3022 | SC | T | |
| 50 | X Bullet R | 06 - | 1 | NA | | 3022 | SC |
| 50 | 101 R | 04 - 09 | 1 | 3039 | SC | T | |
| 50 | 202 Classic | 03 - 09 | 1 | 3039 | SC | T | |
| 50 | 203 | 05 - | 1 | 3078 | SC | T | |
| 50 | 302 Sport | 03 - 09 | 1 | NA | | T | |
| 50 | 303 Revolution | 02 - 03 | 1 | 3022 | SC | T | |
| 50 | 303R Hawk / laser | 04 - | 1 | 3022 | SC | T | |
| 50 | 309 RS | 02 - 03 | 1 | NA | | T | |
| 50 | F409 Cruise | 02 - 05 | 1 | 3022 | SC | T | |
| 90 | Apollo | 99 - | 1 | 3078 | SC | T | |

YAMAHA

| | | | | | | | |
|--------|-----------------|---------|---|------|-----|------|----|
| BWS 50 | Spy | 95 - | 1 | 3013 | SC | T | |
| BWS 50 | Bump | 97 - | 1 | 3013 | SC | T | |
| BWS 50 | Original | 96 - | 1 | 3013 | SC | T | |
| BWS 50 | R | 94 - 95 | 1 | 3013 | SC | T | |
| BWS 50 | Next Generation | 99 - 07 | 1 | 3013 | SC | T | |
| CR 50 | Target | 91 - | 1 | 3029 | SC | T | |
| CR 50 | Z | 91 - 95 | 1 | 3029 | SC | T | |
| CS 50 | JOG (Spain) | 88 - | 1 | 3029 | SC | T | |
| CS 50 | JOG-R | 02 - 05 | 1 | 3013 | SC | T | |
| CS 50 | JOG-R | 06 - 09 | 1 | 3013 | SC | T | |
| CS 50 | Z (JOG-RR) | 03 - 05 | 1 | 3013 | SC | T | |
| CS 50 | Z (JOG-RR) | 06 - 10 | 1 | 3013 | SC | T | |
| CY 50 | RS JOG R | 96 - | 1 | 3029 | SC | T | |
| DT 50 | R | 89 - 97 | 1 | 3008 | SC | T | |
| DT 50 | R | 98 - 03 | 1 | 3004 | SC | T | |
| DT 50 | R | 04 - | 1 | 3015 | SC | 3063 | SC |
| DT 50 | X Supermotard | 04 - | 1 | 3031 | SC | 3063 | SC |
| EW 50 | Slider | 00 - 05 | 1 | 3027 | SC | T | |
| RZ 50 | (5FC1/2) | 02 - | 1 | 3033 | MSC | T | |
| TZM 50 | R | 94 - | 1 | 3036 | SC | 3008 | SC |
| TZR 50 | | 90 - 92 | 1 | 3036 | SC | 3008 | SC |
| TZR 50 | | 93 - 02 | 1 | 3036 | SC | 3008 | SC |
| TZR 50 | | 03 - 08 | 1 | 3031 | SC | 3015 | SC |
| YA 50 | R Axis | 95 - 96 | 1 | 3013 | SC | T | |
| YA 50 | ZA Jog Z | 95 - | 1 | 3029 | SC | T | |
| YE 50 | Zest | 92 - 95 | 1 | 3013 | SC | T | |
| YH 50 | Why | 98 - 09 | 1 | 3013 | SC | T | |
| YM 50 | Breeze | 94 - 95 | 1 | 3013 | SC | T | |
| YN 50 | Neo's (2T) | 97 - 09 | 1 | 3013 | SC | T | |
| YN 50 | Neo's (4T) | 09 - | 1 | 3013 | SC | T | |
| YQ 50 | Aerox / Aerox R | 97 - | 1 | 3013 | SC | 3027 | SC |
| YE 80 | Zest | 93 - | 1 | 3013 | SC | T | |
| BWS100 | | 96 - | 1 | 3029 | SC | T | |
| YN 100 | Neo's | 99 - 03 | 1 | 3013 | SC | T | |
| YQ 100 | Aerox | 00 - 04 | 1 | 3013 | SC | T | |



Maxi- Scooter



ADLY

| | | | | | |
|--------------------|-----|---|------|-----|----------|
| RT 125 Super Sonic | 01- | 2 | 3022 | MSC | T |
| RT 125 Thunderbike | 01- | 2 | 3022 | MSC | 3022 MSC |
| 125 Cat | 01- | 1 | 3029 | MSC | T |

AEON

| | | | | | |
|------------|-----|---|------|-----|---|
| 150 Pulsar | 06- | 1 | 3022 | MSC | T |
| 125 Pulsar | 06- | 1 | 3022 | MSC | T |

APRILIA

| | | | | | |
|--------------------------------|-----------|---|------|-----|----------|
| 125 Atlantic | 03 - | 1 | 3056 | MSC | 3055 MSC |
| 125 Habana | 01 - | | 3064 | MSC | T |
| 125 Leonardo | 99 - | 1 | 3064 | MSC | 3064 MSC |
| 125 Leonardo | 96 | 1 | 3013 | MSC | 3037 MSC |
| 125 Leonardo (Grimeca Caliper) | 99 - | 1 | 3021 | MSC | 3064 MSC |
| 125 Mojito / Mojito Custom | 02 - | 1 | 3064 | MSC | T |
| 125 Scarabéo / Scarabéo GT | 99 - 03 | 1 | 3021 | MSC | 3055 MSC |
| 125 Scarabéo / Scarabéo GT | 04 - | 1 | 3056 | MSC | 3055 MSC |
| 125 Sportcity | 05 - | 1 | 3021 | MSC | 3055 MSC |
| 125 SR | 99 - | 1 | 3064 | MSC | T |
| 125 Leonardo | 97 - 98 | 1 | 3013 | MSC | 3013 MSC |
| 150 Leonardo | 99 - | 1 | 3064 | MSC | 3064 MSC |
| 150 Leonardo (Grimeca Caliper) | 99 - | 1 | 3021 | MSC | 3064 MSC |
| 150 Scarabeo | 99 - 03 | 1 | 3021 | MSC | 3055 MSC |
| 150 Scarabeo | 04 - | 1 | 3056 | MSC | 3055 MSC |
| 150 SR | 00 - | 1 | 3064 | MSC | T |
| 150 Leonardo | 97 - 98 | 1 | 3013 | MSC | 3013 MSC |
| 200 Atlantic | 03 - | 1 | 3056 | MSC | 3055 MSC |
| 200 Scarabéo / Scarabéo GT | 02 - 03 | 1 | 3021 | MSC | 3055 MSC |
| 200 Scarabéo | 07 - | 1 | 3056 | MSC | 3055 MSC |
| 200 Scarabéo Class | 10 - | 1 | 3056 | MSC | 3055 MSC |
| 200 Sportcity | 05 - | 1 | 3021 | MSC | 3055 MSC |
| 250 Atlantic ie | 07 - | 1 | 3056 | MSC | 3055 MSC |
| 250 Leonardo | 99 - 01 | 1 | 3064 | MSC | 3055 MSC |
| 250 Leonardo (Grimeca Caliper) | 99 - | 1 | 3021 | MSC | 3055 MSC |
| 250 Leonardo | 02 - | 1 | 3056 | MSC | 3055 MSC |
| 250 Scarabéo / Scarabéo ie | 06 - | 1 | 3056 | MSC | 3055 MSC |
| 250 Sportcity ie | 07 - | 1 | 3021 | MSC | 3055 MSC |
| 300 Leonardo (Grimeca Caliper) | 05 - | 1 | 3021 | MSC | 3064 MSC |
| 300 Scarabéo Special | 10 - | 1 | 3056 | MSC | 3055 MSC |
| 400 Scarabéo ie | 07 - | 1 | 3021 | MSC | 3055 MSC |
| 500 Atlantic | 02 - 05 L | 1 | 3021 | MSC | 3055 MSC |
| 500 Atlantic | 02 - 05 R | 1 | 3072 | MSC | |
| 500 Atlantic Sprint | 06 - | 1 | 3056 | MSC | 3055 MSC |
| 500 Scarabéo | 03 - 09 L | 1 | 3021 | MSC | 3055 MSC |
| 500 Scarabéo | 03 - 09 R | 1 | 3072 | MSC | |
| 500 Scarabéo Class | 10 - | 1 | 3021 | MSC | 3055 MSC |

ATALA

| | | | | | |
|------------|------|---|------|-----|---|
| 125 Hacker | 98 - | 1 | 3013 | MSC | T |
|------------|------|---|------|-----|---|

BENELLI

| | | | | | |
|-----------------------------|--------|---|------|-----|----------|
| 125 Adiva | 00 - | 1 | 3013 | MSC | 3054 MSC |
| 125 Caffenero | 08 - L | 1 | 3087 | MSC | 3087 MSC |
| 125 Caffenero | 08 - R | 1 | 3062 | MSC | |
| 125 Macis | 10 - | 1 | 3087 | MSC | 3087 MSC |
| 125 Velvet / Velvet Touring | 99 - | 1 | 3013 | MSC | 3013 MSC |
| 150 Adiva | 00 - | 1 | 3013 | MSC | 3054 MSC |
| 150 Macis | 10 - | 1 | 3087 | MSC | 3087 MSC |
| 150 Velvet / Velvet Touring | 00 - | 1 | 3013 | MSC | 3013 MSC |
| 250 Caffenero | 08 - L | 1 | 3087 | MSC | 3087 MSC |
| 250 Caffenero | 08 - R | 1 | 3062 | MSC | |
| 250 Velvet / Velvet Touring | 99 - | 1 | 3013 | MSC | 3013 MSC |
| 400 Velvet Dusk | 03 - | 1 | 3031 | MSC | 3013 MSC |

CAGIVA

| | | | | | |
|--------------|------|---|------|-----|---|
| 125 Brillo | 08 - | 1 | 3047 | MSC | T |
| 125 Cucciolo | 00 - | 1 | 3013 | MSC | T |
| 125 Nuvola | 00 - | 1 | 3013 | MSC | T |

BETA

| | | | | | |
|-----------|---------|---|------|-----|----------|
| 125 Eikon | 99 - 03 | 1 | 3015 | MSC | 3015 MSC |
| 125 Eikon | 04 - | 1 | 3013 | MSC | 3055 MSC |
| 150 Eikon | 99 - 03 | 1 | 3015 | MSC | 3015 MSC |
| 150 Eikon | 04 - | 1 | 3013 | MSC | 3055 MSC |
| 250 Eikon | 99 - | 1 | 3015 | MSC | 3015 MSC |

CPI

| | | | | | |
|---------------|------|---|------|-----|----------|
| 125 Aragon GP | 07 - | 1 | 3047 | MSC | |
| 125 GTR / GTS | 02 - | 1 | 3031 | MSC | 3013 MSC |

CPI

| | | | | | |
|---------------|------|---|------|-----|----------|
| 125 X-large | 02 - | 2 | 3057 | MSC | 3057 MSC |
| 200 GTR / GTS | 02 - | 1 | 3031 | MSC | 3013 MSC |
| 200 X-large | 02 - | 2 | 3057 | MSC | 3057 MSC |

DAELIM

| | | | | | |
|----------------------|------|---|------|-----|----------|
| NS 125 II | 00 - | 1 | 3018 | MSC | T |
| S2 125 | 05 - | 1 | 3065 | MSC | 3018 MSC |
| 125 Delfino | 08 - | 1 | 3078 | MSC | |
| 125 DLX / Otello DLX | 01 - | 1 | 3018 | MSC | 3018 MSC |
| 125 History | 01 - | 1 | 3018 | MSC | 3018 MSC |
| 125 Message II | 00 - | 1 | 3018 | MSC | T |
| 125 Otello | 99 - | 1 | 3018 | MSC | T |
| 125 Otello | 08 - | 1 | 3049 | MSC | 3018 MSC |
| 125 S2 FI | 07 - | 1 | 3049 | MSC | 3018 MSC |
| 125 U3 FI | 07 - | 1 | 3049 | MSC | 3018 MSC |
| S2 250 Free Wind | 05 - | 1 | 3065 | MSC | 3018 MSC |

DERBI

| | | | | | |
|----------------|------|---|------|-----|----------|
| 125 Atmosphere | 99 - | 1 | 3015 | MSC | T |
| 125 Boulevard | 04 - | 1 | 3015 | MSC | T |
| 125 GP1 | 05 - | 1 | 3057 | MSC | 3015 MSC |
| 125 Predator | 99 - | 1 | 3015 | MSC | 3015 MSC |
| 150 Boulevard | 04 - | 1 | 3015 | MSC | T |
| 250 GP1 | 05 - | 1 | 3057 | MSC | NA |

GARELLI

| | | | | | |
|--------------|------|---|------|-----|----------|
| 125 Freeland | 02 - | 1 | 3039 | MSC | T |
| 125 Panther | 02 - | 1 | 3038 | MSC | 3013 MSC |
| 125 Raider | 02 - | 1 | 3022 | MSC | T |
| 125 T-Rex | 00 - | 1 | 3039 | MSC | T |
| 150 Freeland | 02 - | 1 | 3039 | MSC | T |
| 150 Panther | 02 - | 1 | 3038 | MSC | 3013 MSC |
| 250 Panther | 02 - | 1 | 3038 | MSC | 3013 MSC |

GENERIC

| | | | | | |
|------------|------|---|------|-----|--|
| 125 Soho | 07 - | 1 | 3047 | MSC | |
| 125 Stroke | 08 - | 1 | 3047 | MSC | |
| 125 XOR | 07 - | 1 | 3047 | MSC | |
| 125 Zion | 08 - | 1 | 3047 | MSC | |

GILERA

| | | | | | |
|--------------------------------------|---------|---|------|-----|----------|
| DNA 125 (Grimeca Caliper) | 01 - | 1 | 3031 | MSC | 3057 MSC |
| DNA 125 (Hengtong Caliper) | 01 - | 1 | 3060 | MSC | 3057 MSC |
| FX 125 Runner | 97 - 99 | 1 | 3069 | MSC | T |
| FX 125 Runner/SP (Grimeca Caliper) | 00 - | 1 | 3031 | MSC | 3043 MSC |
| FX 125 Runner/SP (Hengtong Caliper) | 00 - | 1 | 3060 | MSC | 3043 MSC |
| FX 125 Nexus | 07 - | 2 | 3060 | MSC | 3060 MSC |
| SC 125 | 06 - | 1 | NA | | 3015 MSC |
| ST 125 Runner | 08 - | 1 | 3060 | MSC | 3054 MSC |
| VX 125 Runner 4T (Grimeca Caliper) | 01 - | 1 | 3031 | MSC | 3054 MSC |
| VX 125 Runner 4T (Hengtong Caliper) | 01 - | 1 | 3060 | MSC | 3054 MSC |
| 125 Surfer | 01 - | 1 | 3015 | MSC | 3015 MSC |
| 125 Typhoon | 96 - | 1 | 3045 | MSC | T |
| FX 150 Runner | 97 - | 1 | 3069 | MSC | T |
| 175 Mad Mud | 02 - | 1 | 3031 | MSC | 3013 MSC |
| DNA 180 (Grimeca Caliper) | 01 - | 1 | 3031 | MSC | 3057 MSC |
| DNA 180 (Hengtong Caliper) | 01 - | 1 | 3060 | MSC | 3057 MSC |
| FXR 180 Runner | 98 - 99 | 1 | 3031 | MSC | T |
| FXR 180 Runner | 97 | 1 | 3069 | MSC | T |
| FXR 180 Runner/SP (Grimeca Caliper) | 00 - | 1 | 3031 | MSC | 3043 MSC |
| FXR 180 Runner/SP (Hengtong Caliper) | 00 - | 1 | 3060 | MSC | 3043 MSC |
| VXR 180 Runner | 01 - | 1 | 3060 | MSC | T |
| VXR 180 Runner 4T (Grimeca Caliper) | 01 - | 1 | 3031 | MSC | 3054 MSC |
| VXR 180 Runner 4T (Hengtong Caliper) | 01 - | 1 | 3060 | MSC | 3054 MSC |
| FX 200 Runner | 97 - 98 | 1 | 3069 | MSC | T |
| FX 200 Runner SP | 98 - | 1 | 3031 | MSC | 3043 MSC |
| VXR 200 Runner 4T (Hengtong Caliper) | 01 - | 1 | 3060 | MSC | 3054 MSC |
| VXR 200 Runner 4T (Grimeca Caliper) | 01 - | 1 | 3031 | MSC | 3054 MSC |
| ST 200 Runner | 08 - | 1 | 3060 | MSC | 3054 MSC |
| 200 Stalker | 97 - | 1 | 3013 | MSC | 3043 MSC |
| 250 Nexus | 07 - | 2 | 3060 | MSC | 3060 MSC |
| 500 Nexus | 04 - | 2 | 3028 | MSC | 3057 MSC |
| RC 500 Fuoco ie | 08 - | 2 | 3043 | MSC | 3084 MSC |
| GP 800 | 08 - | 2 | 3028 | MSC | 3060 MSC |

HONDA

| | | | | | |
|----------------|------|---|------|-----|---|
| SCV 110 Lead | 08 - | 1 | 3073 | MSC | T |
| ANF 125 Innova | 03 - | 1 | 3080 | MSC | T |
| CH 125 Spacy | 94 - | 1 | 3073 | MSC | T |

1-2-4 = Nombre de jeux / Number of sets / Anzahl Sets Numero blister / Numero des juegos

L = Gauche / Left / Links / Sinistra / Izquierda

R = Droite / Right / Rechts / Destra / Derecha

NA = Non Attribué / Not Available / Nicht verfügbar / Non disponibile / No disponible

T = Tambour / Mechanical Drum / Strommel / Tamburo / Tambor

Maxi-Scooter



HONDA

| | | | | | | |
|---------------------------------------|---------|---|------|-----|------|-----|
| FES 125 Panthéon | 98 - 02 | 1 | 3026 | MSC | T | |
| FES 125 Panthéon | 03 - | 1 | 3026 | MSC | 3076 | MSC |
| FES 125 S-wing | 07 - | 1 | 3082 | MSC | 3083 | MSC |
| NES 125 @ | 01 - | 1 | 3019 | MSC | T | |
| R 125 Lead | 88 - | 1 | 3009 | MSC | T | |
| SH 125 | 02 - 08 | 1 | 3019 | MSC | T | |
| SH 125 i | 09 - | 1 | 3082 | MSC | 3083 | MSC |
| SES 125 Dylan | 02 - | 1 | 3073 | MSC | T | |
| PS 125 i | 07 - | 1 | 3073 | MSC | T | |
| FES 150 Panthéon | 99 - 02 | 1 | 3026 | MSC | T | |
| FES 150 Panthéon | 03 - | 1 | 3026 | MSC | 3076 | MSC |
| FES 150 S-wing | 08 - | 1 | 3082 | MSC | 3083 | MSC |
| NES 150 @ | 01 - | 1 | 3019 | MSC | T | |
| PS 150 i | 07 - | 1 | 3073 | MSC | T | |
| SES 150 Dylan | 02 - | 1 | 3073 | MSC | T | |
| SH 150 | 02 - 08 | 1 | 3019 | MSC | T | |
| SH 150 i | 09 - | 1 | 3082 | MSC | 3083 | MSC |
| CH 250 Spacy | 85 - 86 | 1 | 3019 | MSC | T | |
| CH 250 Spacy / Freeway Fusion | 88 - | 1 | 3019 | MSC | T | |
| CN 250 Hélix | 86 - 87 | 1 | 3011 | MSC | T | |
| CN 250 Helix (Fusion) | 92 | 1 | 3017 | MSC | T | |
| CN 250 Helix (Fusion) | 93 - | 1 | 3003 | MSC | T | |
| CN 250 Scooter | 88 - 92 | 1 | 3017 | MSC | T | |
| CN 250 Scooter | 93 - | 1 | 3017 | MSC | T | |
| CN 250 Spazio | 88 - 89 | 1 | 3019 | MSC | T | |
| CN 250 Spazio | 90 - 97 | 1 | 3017 | MSC | T | |
| FES 250 Foresight | 98 - 99 | 1 | 3026 | MSC | T | |
| FES 250 Foresight | 00 - | 1 | 3026 | MSC | 3076 | MSC |
| NSS 250 Forza | 00 - 04 | 1 | 3026 | MSC | 3079 | MSC |
| NSS 250 Forza | 05 - | 1 | 3082 | MSC | 3083 | MSC |
| NSS 250 Jazz | 01 - 04 | 1 | 3026 | MSC | 3079 | MSC |
| NSS 250 Jazz | 05 - | 1 | 3082 | MSC | 3083 | MSC |
| PS 250 | 05 - | 1 | 3082 | MSC | T | |
| SH 300 i / i (ABS) | 07 - | 1 | 3082 | MSC | 3083 | MSC |
| FJS 400 Silver Wing | 06 - 08 | 1 | 3026 | MSC | 3059 | MSC |
| FJS 400 Silver Wing T | 09 - | 1 | 3082 | MSC | 3059 | MSC |
| SWT400 / ABS | 09 - | 1 | 3082 | MSC | 3059 | MSC |
| FJS 600 Silver Wing / Silver Wing ABS | 01 - | 2 | 3026 | MSC | 3059 | MSC |

HYOSUNG

| | | | | | | |
|----------------|------|---|------|-----|----|--|
| GPS 125 D | 00 - | 1 | 3013 | MSC | T | |
| 125 Boomer | 03 - | 1 | 3013 | MSC | NA | |
| 125 Exceed | 02 - | 1 | 3013 | MSC | NA | |
| 125 Grand Prix | 98 - | 1 | 3013 | MSC | T | |
| 125 Hyper | 99 - | 1 | 3013 | MSC | T | |
| 150 Exceed | 02 - | 1 | 3013 | MSC | NA | |
| 150 Grand Prix | 98 - | 1 | 3013 | MSC | T | |

ITALJET

| | | | | | | |
|--------------------|---------|---|------|-----|------|-----|
| 100 Millenium | 00 - 01 | 1 | 3022 | MSC | T | |
| 100 Millenium | 02 - | 1 | 3063 | MSC | T | |
| 125 Amarcord | 08 - | 1 | 3014 | MSC | T | |
| 125 Dragster | 97 - | 1 | 3015 | MSC | 3015 | MSC |
| 125 Formula | 96 - | 1 | 3015 | MSC | 3015 | MSC |
| 125 Formula LC | 99 - | 1 | 3015 | MSC | 3015 | MSC |
| 125 Jet Set | 03 - | 1 | 3063 | MSC | T | |
| 125 Jupiter | 02 - | 1 | 3025 | MSC | 3033 | MSC |
| 125 Millenium | 00 - 01 | 1 | 3022 | MSC | T | |
| 125 Millenium | 02 - | 1 | 3063 | MSC | T | |
| 125 Torpedo 4T Pro | 99 - 09 | 1 | 3015 | MSC | T | |
| 125 Torpedo | 07 - | 1 | 3073 | MSC | T | |
| 125 Twin | 99 - | 1 | 3015 | MSC | 3015 | MSC |
| 150 Jet Set | 03 - | 1 | 3063 | MSC | T | |
| 150 Jupiter | 02 - | 1 | 3025 | MSC | 3033 | MSC |
| 150 Millenium | 00 - 01 | 1 | 3022 | MSC | T | |
| 150 Millenium | 02 - | 1 | 3063 | MSC | T | |
| 150 Torpedo 4T Pro | 00 - | 1 | 3015 | MSC | T | |
| 150 Torpedo | 07 - | 1 | 3073 | MSC | T | |
| 180 Dragster | 99 - | 1 | 3015 | MSC | 3015 | MSC |
| 250 Jupiter | 02 - | 1 | 3025 | MSC | 3081 | MSC |

JONWAY

| | | | | | | |
|-------------|---------|---|------|-----|------|-----|
| YY 125 | 08 - 09 | 1 | 3062 | MSC | 3062 | MSC |
| YY 150 | 08 - 09 | 1 | 3062 | MSC | 3062 | MSC |
| YY 150 T-19 | 08 - 09 | 1 | 3096 | MSC | 3096 | MSC |
| YY 250 / A | 08 - 09 | 1 | 3062 | MSC | 3062 | MSC |
| YY 250 T-19 | 08 - 09 | 1 | 3096 | MSC | 3096 | MSC |

KAWASAKI

| | | | | | | |
|----------------|------|---|------|-----|------|-----|
| SC 250 Epsilon | 02 - | 1 | 3049 | MSC | 3074 | MSC |
|----------------|------|---|------|-----|------|-----|

KEEWAY

| | | | | | | |
|-------------------------|---------|---|------|-----|------|-----|
| 125 Arn | 06 - | 1 | 3013 | MSC | T | |
| 125 Focus | 06 - | 1 | 3047 | MSC | T | |
| 125 Matrix | 06 | 1 | 3022 | MSC | T | |
| 125 Matrix | 07 - 10 | 1 | 3047 | MSC | T | |
| 125 Matrix Racing Sport | 10 - | 1 | 3047 | MSC | T | |
| 125 Outlook | 07 - 10 | 1 | 3078 | MSC | 3078 | MSC |
| 150 Arn | 06 - | 1 | 3013 | MSC | T | |
| 150 Focus | 06 - | 1 | 3047 | MSC | T | |
| 150 Matrix | 06 - | 1 | 3047 | MSC | T | |
| 150 Matrix Racing Sport | 10 - | 1 | 3047 | MSC | T | |

KYMCO

| | | | | | | | |
|--------------------|---------|---|------|------|------|------|-----|
| 125 Agility | 06 - | 1 | 3078 | MSC | T | | |
| 125 B&W | 99 - | 1 | 3062 | MSC | 3062 | MSC | |
| 125 Calypso | 99 - | 1 | 3047 | MSC | T | | |
| 125 Dink | 96 - | 1 | 3062 | MSC | 3062 | MSC | |
| 125 Downtown i | 10 - | 1 | 3003 | MSC | 3094 | MSC | |
| 125 Freeway | 93 - 95 | 1 | 3037 | MSC | T | | |
| 125 Grand Dink | 02 - | 1 | 3062 | MSC | 3062 | MSC | |
| 125 Heroism | 95 - | 1 | 3047 | MSC | T | | |
| 125 Jetix | 08 - | 1 | 3096 | MSC | T | | |
| 125 Movie | 99 - | 1 | 3062 | MSC | T | | |
| 125 Movie XL | 01 - | 1 | 3062 | MSC | T | | |
| 125 New Dink | 08 - | 1 | 3062 | MSC | 3062 | MSC | |
| 125 Nexxon | 07 - | 1 | 3096 | MSC | 3096 | MSC | |
| 125 People | 01 - | 1 | 3068 | MSC | T | | |
| 125 Spacer | 99 - | 1 | 3062 | MSC | 3062 | MSC | |
| 125 Spike | 02 - | 1 | 3096 | MSC | T | | |
| 125 Super 8 | 08 - | 1 | 3068 | MSC | T | | |
| 125 Super 9 | 00 - | 1 | 3014 | MSC | 3068 | MSC | |
| 125 Techno GT | 06 - | 1 | 3062 | MSC | T | | |
| 125 Vivio | 01 - | 1 | 3078 | MSC | T | | |
| 125 Yager | 01 - | 1 | 3062 | MSC | 3062 | MSC | |
| 125 Yager GT | 09 - | 1 | 3062 | MSC | T | | |
| S 125 People | 05 - | 1 | 3068 | MSC | 3089 | MSC | |
| 150 B&W | 01 - | 1 | 3062 | MSC | 3062 | MSC | |
| 150 Dink | 99 - | 1 | 3062 | MSC | 3062 | MSC | |
| 150 Freeway | 95 - | 1 | 3006 | MSC | T | | |
| 150 Grand Dink | 02 - | 1 | 3062 | MSC | 3062 | MSC | |
| 150 Heroism | 95 - | 1 | 3047 | MSC | 3041 | MSC | |
| 150 Movie XL | 01 - | 1 | 3062 | MSC | T | | |
| 150 People | 01 - | 1 | 3068 | MSC | T | | |
| 150 Spacer | 99 - | 1 | 3062 | MSC | 3062 | MSC | |
| 150 Straight | 08 - | 1 | 3096 | MSC | 3096 | MSC | |
| 150 Vivio | 01 - | 1 | 3078 | MSC | T | | |
| 150 Yager | 01 - | 1 | 3062 | MSC | 3062 | MSC | |
| 200 Dink | 04 - | 1 | 3062 | MSC | 3062 | MSC | |
| 200 Downtown i | 10 - | 1 | 3003 | MSC | 3094 | MSC | |
| 200 i New Dink | 08 - | 1 | 3062 | MSC | 3062 | MSC | |
| 200 Like i | 09 | 1 | 3068 | MSC | 3062 | MSC | |
| 200 Like i | 10 | 1 | 3078 | MSC | 3062 | MSC | |
| 200 Yager | 04 - | 1 | 3062 | MSC | 3062 | MSC | |
| S 200 People | 05 - | 1 | 3068 | MSC | 3089 | MSC | |
| 250 B&W | 01 - | 1 | 3062 | MSC | 3062 | MSC | |
| 250 Grand Dink | 01 - | 1 | 3070 | MSC | 3071 | MSC | |
| 250 People | 03 - | 1 | 3062 | MSC | T | | |
| S 250 People | 06 - | R | 1 | 3062 | MSC | 3089 | MSC |
| S 250 People | 06 - | L | 1 | 3078 | MSC | T | |
| 250 Super 9 | 00 - | 1 | 3014 | MSC | 3068 | MSC | |
| 250 Xciting | 04 - 05 | 1 | 3003 | MSC | 3003 | MSC | |
| 250 Xciting | 06 - | 1 | 3003 | MSC | 3089 | MSC | |
| 250 Yup | 03 - | 1 | 3062 | MSC | 3062 | MSC | |
| 300 Downtown i ABS | 10 - | 1 | 3003 | MSC | 3094 | MSC | |
| 300 People Gti | 10 - | 1 | 3003 | MSC | 3089 | MSC | |
| 300 People Si | 08 - | R | 1 | 3078 | MSC | 3089 | MSC |
| 300 People Si | 08 - | L | 1 | 3062 | MSC | | |
| 300 Xciting Ri | 08 - | 2 | 3003 | MSC | 3089 | MSC | |
| 500 Xciting | 04 - | 2 | 3003 | MSC | 3003 | MSC | |
| 500 Xciting R ABS | 09 - | 2 | 3003 | MSC | 3003 | MSC | |
| 700 MyRoad | 09 - | 2 | 3003 | MSC | 3003 | MSC | |

LAVERDA

| | | | | | | |
|-------------|------|---|------|-----|------|-----|
| 125 Phoenix | 01 - | 1 | 3067 | MSC | 3068 | MSC |
| 150 Phoenix | 01 - | 1 | 3067 | MSC | 3068 | MSC |
| 200 Phoenix | 01 - | 1 | 3067 | MSC | 3068 | MSC |



MALAGUTI

| | | | | | | |
|------------------------|---------|---|------|-----|------|-----|
| Ciak (Electric Power) | 00 - 05 | 1 | 3013 | MSC | T | |
| 125 Blog | 10 - | 1 | 3078 | MSC | 3022 | MSC |
| 125 Centro ie | 08 - | 1 | 3078 | MSC | 3008 | MSC |
| 125 F-18 | 00 - | 1 | 3013 | MSC | 3055 | MSC |
| 125 Ciak / Ciak Master | 01 - 08 | 1 | 3013 | MSC | T | |
| 125 Madison | 99 - | 1 | 3031 | MSC | 3055 | MSC |
| 125 Phantom Max | 04 - | 1 | 3031 | MSC | 3055 | MSC |
| 125 Runner | 87 - | 1 | 3020 | MSC | T | |
| 150 F-18 | 00 - | 1 | 3013 | MSC | 3013 | MSC |
| 150 Ciak / Ciak Master | 01 - 08 | 1 | 3013 | MSC | T | |
| 150 Madison | 99 - | 1 | 3031 | MSC | 3055 | MSC |
| 160 Blog | 10 - | 1 | 3078 | MSC | 3022 | MSC |
| 160 Centro ie | 08 - | 1 | 3078 | MSC | 3008 | MSC |
| 180 Madison | 02 - | 1 | 3031 | MSC | 3055 | MSC |
| 200 Madison | 03 - | 1 | 3031 | MSC | 3055 | MSC |
| 200 Phantom Max | 04 - | 1 | 3031 | MSC | 3055 | MSC |
| 250 Madison S | 99 - 03 | 1 | 3056 | MSC | 3055 | MSC |
| 250 Madison RS | 04 - 07 | 1 | 3031 | MSC | 3055 | MSC |
| 250 Madison ie | 06 - | 1 | 3031 | MSC | 3055 | MSC |
| 250 Password | 05 - | 1 | 3031 | MSC | 3055 | MSC |
| 250 Phantom Max | 04 - 08 | 1 | 3031 | MSC | 3055 | MSC |
| 400 Madison K | 02 - 06 | 1 | 3056 | MSC | 3055 | MSC |
| 500 Spidermax GT | 04 - | 2 | 3020 | MSC | 3055 | MSC |
| 500 Spidermax RS | 09 - | 2 | 3020 | MSC | 3055 | MSC |

MBK

| | | | | | | |
|--------------------|---------|---|------|-----|------|-----|
| 125 Cityliner | 08 - | 1 | 3059 | MSC | 3033 | MSC |
| 125 Doodo | 00 - 05 | 1 | 3013 | MSC | T | |
| 125 Flame R / F | 96 - 03 | 1 | 3008 | MSC | T | |
| 125 Flame X | 04 - 10 | 1 | 3069 | MSC | T | |
| 125 Skycruiser | 06 - 09 | 1 | 3085 | MSC | 3057 | MSC |
| 125 Skycruiser | 10 - | 1 | 3097 | MSC | 3057 | MSC |
| 125 Skycruiser ABS | 11 - | 1 | 3097 | MSC | 3095 | MSC |
| 125 Skyliner | 98 - 00 | 1 | 3028 | MSC | T | |
| 125 Skyliner | 01 - 10 | 1 | 3028 | MSC | 3057 | MSC |
| 125 Thunder | 01 - 03 | 1 | 3028 | MSC | 3057 | MSC |
| 125 Waap | 08 - | 1 | 3099 | MSC | T | |
| 125 X-Over | 10 - | 1 | 3098 | MSC | T | |
| 150 Doodo | 00 - 05 | 1 | 3013 | MSC | T | |
| 150 Skyliner | 01 - | 1 | 3028 | MSC | 3057 | MSC |
| 150 Thunder | 01 - 03 | 1 | 3028 | MSC | 3057 | MSC |
| 150 Vertex | 97 - | 1 | 3028 | MSC | T | |
| 180 Skyliner | 04 - | 1 | 3028 | MSC | 3057 | MSC |
| 250 Skyliner | 96 - 98 | 1 | 3025 | MSC | T | |
| 250 Skyliner | 99 - 02 | 1 | 3025 | MSC | 3033 | MSC |
| 300 Kilibre | 03 - 04 | 1 | 3028 | MSC | 3028 | MSC |
| 400 Skyliner | 04 - | 1 | 3025 | MSC | 3075 | MSC |

MZ / MUZ

| | | | | | | |
|---------------|---------|---|------|-----|---|--|
| 125 Mantizz S | 05 - 07 | 1 | 3073 | MSC | T | |
| 125 Moskito | 02 | 1 | 3022 | MSC | T | |

PEUGEOT

| | | | | | | |
|-------------------------------------|---------|---|------|-----|------|-----|
| E-Vivacity (Electric) | 10 - | 1 | 3047 | MSC | T | |
| 125 Citystar | 11 - | 1 | 3060 | MSC | 3055 | MSC |
| 125 Elyseo (AJP Caliper) | 98 - 01 | 1 | 3015 | MSC | T | |
| 125 Elyseo | 03 - | 1 | 3031 | MSC | 3063 | MSC |
| 125 Elystar | 03 - | 1 | 3031 | MSC | 3063 | MSC |
| SV 125 Geo | 91 - 92 | 1 | 3006 | MSC | T | |
| SV 125 Geo / L Executive | 93 - | 1 | 3006 | MSC | T | |
| 125 Geopolis | 06 - | 1 | 3031 | MSC | 3063 | MSC |
| 125 Geopolis RS | 08 - 10 | 1 | 3078 | MSC | 3078 | MSC |
| 125 Jet Force / Compressor | 03 - | 1 | 3031 | MSC | 3063 | MSC |
| 125 Looxor | 03 - 08 | 1 | 3056 | MSC | 3015 | MSC |
| 125 LXR | 10 - | 1 | 3031 | MSC | 3089 | MSC |
| 125 Satelis | 06 - 09 | 1 | 3031 | MSC | 3063 | MSC |
| 125 Satelis Compressor | 06 - 10 | 1 | 3031 | MSC | 3063 | MSC |
| 125 Satelis RS | 07 - 10 | 1 | 3031 | MSC | 3063 | MSC |
| 125 Satelis (Nissin Caliper) | 08 - 09 | 1 | 3078 | MSC | 3078 | MSC |
| 125 Sum-Up | 08 - | 1 | 3018 | MSC | T | |
| 125 Tweet | 10 - | 1 | 3039 | MSC | 3013 | MSC |
| 125 Vivacity (4T) | 10 - | 1 | 3078 | MSC | T | |
| 150 Elyseo | 01 - | 1 | 3031 | MSC | 3063 | MSC |
| 150 Elystar | 03 - | 1 | 3031 | MSC | 3063 | MSC |
| 150 Looxor | 03 - | 1 | 3056 | MSC | 3015 | MSC |
| 150 Tweet | 10 - | 1 | 3039 | MSC | 3013 | MSC |
| 200 LXR | 10 - | 1 | 3031 | MSC | 3089 | MSC |
| 250 Geopolis (AJP Caliper) / ABS | 06 - 09 | 1 | 3031 | MSC | 3063 | MSC |
| 250 Geopolis (Nissin Caliper) / ABS | 06 - 09 | 1 | 3078 | MSC | 3078 | MSC |

PEUGEOT

| | | | | | | |
|-------------------------------------|---------|---|------|-----|------|-----|
| 250 Satelis (AJP Caliper) | 07 - 10 | 1 | 3031 | MSC | 3063 | MSC |
| 250 Satelis (Nissin Caliper) | 06 - 10 | 1 | 3078 | MSC | 3060 | MSC |
| 300 Geopolis | 10 - | 1 | 3078 | MSC | 3078 | MSC |
| 300 Geostyle | 10 - | 1 | 3078 | MSC | 3078 | MSC |
| 400 Geopolis (AJP Caliper) | 07 - 10 | 1 | 3031 | MSC | 3063 | MSC |
| 400 Geopolis (Nissin Caliper) / ABS | 07 - 10 | 1 | 3078 | MSC | 3078 | MSC |
| 400 Geopolis RS | 08 - 10 | 1 | 3065 | MSC | 3078 | MSC |
| 400 Satelis | 07 - 10 | 2 | 3065 | MSC | 3078 | MSC |
| 500 Satelis | 07 - 10 | 2 | 3065 | MSC | 3078 | MSC |
| 600 Satelis ABS | 04 - | 1 | 3065 | MSC | 3063 | MSC |

PGO

| | | | | | | |
|-----------------------------|------|---|------|-----|------|-----|
| i-Dep (Electric) | 09 - | 1 | 3039 | MSC | T | |
| 125 Charge A / B | 02 - | 1 | 3039 | MSC | T | |
| 125 I-Charge Fuel injection | 03 - | 1 | 3078 | MSC | T | |
| 125 Kung Fu | | 1 | T | T | 3029 | MSC |
| 125 Libra | 10 - | 1 | 3087 | MSC | T | |
| 125 Ligero | 06 - | 1 | 3039 | MSC | T | |
| 125 My Bubu / Young Bubu | 02 - | 1 | 3039 | MSC | T | |
| 125 T Rex | 99 - | 1 | 3039 | MSC | T | |
| 125 Tornado | 96 - | 1 | 3029 | MSC | T | |
| 125 X Hot | 10 - | 1 | 3087 | MSC | T | |
| 150 TR3 | 02 - | 1 | 3039 | MSC | T | |
| 150 T-Rex | 01 - | 1 | 3039 | MSC | T | |

PIAGGIO

| | | | | | | |
|----------------------------------------------|-----------|---|------|-----|------|-----|
| 125 Beverly (Hengtong Caliper) | 02 - 06 | 1 | 3060 | MSC | 3060 | MSC |
| 125 Beverly (Grimeca Caliper) | 02 - 06 | 1 | 3031 | MSC | 3031 | MSC |
| 125 Beverly / S | 07 - | 1 | 3060 | MSC | 3060 | MSC |
| 125 Beverly Tourer | 08 - 09 | 1 | 3060 | MSC | 3060 | MSC |
| 125 Carnaby | 07 - 09 | 1 | 3060 | MSC | 3060 | MSC |
| 125 Fly | 05 - 09 | 1 | 3060 | MSC | T | |
| GT 125 L | 04 - | 1 | 3060 | MSC | 3054 | MSC |
| GTS 125 | 07 - | 1 | 3060 | MSC | 3054 | MSC |
| GTV 125 | 08 - | 1 | 3060 | MSC | 3084 | MSC |
| GTX 125 Super Hexagon (Grimeca Caliper) 11' | 00 - | 1 | 3031 | MSC | 3054 | MSC |
| GTX 125 Super Hexagon (Hengtong Caliper) 11' | 00 - | 1 | 3060 | MSC | 3054 | MSC |
| GTX 125 Super Hexagon (Hengtong Caliper) 12' | 00 - | 1 | 3060 | MSC | 3054 | MSC |
| LE 125 Liberty / S | 98 - 10 | 1 | 3043 | MSC | T | |
| 125 Hexagon | 94 - 95 | 1 | 3013 | MSC | T | |
| 125 Hexagon | 96 - 97 | 1 | 3045 | MSC | T | |
| LX 125 Hexagon | 98 - 99 | 1 | 3031 | MSC | T | |
| LX4 125 Hexagon | 98 - 99 | 1 | 3031 | MSC | T | |
| LX 125 4T | 05 - | 1 | 3043 | MSC | T | |
| LXV 125 | 08 - | 1 | 3013 | MSC | T | |
| 125 MP3 | 06 - 08 | 2 | 3043 | MSC | 3084 | MSC |
| 125 MP3 ie | 08 - 10 | 2 | 3043 | MSC | 3084 | MSC |
| 125 MP3 Hybrid | 09 - 10 | 2 | 3043 | MSC | 3084 | MSC |
| PX 125 | 99 - 01 | 1 | 3053 | MSC | T | |
| PX 125 | 02 - | 1 | 3043 | MSC | T | |
| 125 Sfera | 95 - | 1 | 3043 | MSC | T | |
| 125 Skipper | 93 - 95 | 1 | 3053 | MSC | T | |
| 125 Skipper | 96 - 98 | 1 | 3045 | MSC | T | |
| LX 125 Skipper / ST | 99 - | 1 | 3031 | MSC | T | |
| 125 Typhoon | 96 - | 1 | 3045 | MSC | T | |
| 125 Typhoon Catalysed | 02 - | 1 | 3013 | MSC | 3013 | MSC |
| ET4 125 Vespa | 96 - | 1 | 3043 | MSC | T | |
| 125 X7 | 08 - | 1 | 3060 | MSC | 3077 | MSC |
| 125 X8 | 04 | 2 | 3060 | MSC | 3057 | MSC |
| 125 X8 | 05 - | 2 | 3060 | MSC | 3084 | MSC |
| 125 X9 | 01 - 03 | 2 | 3057 | MSC | 3057 | MSC |
| 125 X9 | 04 - 05 L | 1 | 3060 | MSC | 3057 | MSC |
| 125 X9 | 04 - 05 R | 1 | 3077 | MSC | | |
| 125 X9 Evo (Brembo Caliper) | 03 - 04 | 2 | 3057 | MSC | 3057 | MSC |
| 125 X9 Evo (Hengtong Caliper) | 06 - L | 1 | 3060 | MSC | 3084 | MSC |
| 125 X9 Evo (Hengtong Caliper) | 06 - R | 1 | 3077 | MSC | | |
| 125 Xevo | 08 - | 1 | 3060 | MSC | 3077 | MSC |
| 125 Zip II 4T | 00 - | 1 | 3043 | MSC | T | |
| S 125 4T | 07 - | 1 | 3043 | MSC | T | |
| SKR 125 | 94 - | 1 | 3013 | MSC | T | |
| TPH 125 | 96 - | 1 | 3045 | MSC | T | |
| 150 Fly | 05 - 09 | 1 | 3060 | MSC | T | |
| 150 Hexagon | 94 - 95 | 1 | 3013 | MSC | T | |
| 150 Hexagon | 96 - 97 | 1 | 3045 | MSC | T | |
| 150 Liberty | 99 - 09 | 1 | 3043 | MSC | T | |
| 150 Skipper | 94 - | 1 | 3053 | MSC | T | |
| 150 X8 Street | 06 - | 1 | 3060 | MSC | T | |
| ET4 150 | 02 - | 1 | 3043 | MSC | T | |
| LX 150 | 08 - | 1 | 3013 | MSC | T | |

1-2-4 = Nombre de jeux / Number of sets / Anzahl Sets Numero blister / Numero des juegos

L = Gauche / Left / Links / Sinistra / Izquierda

R = Droite / Right / Rechts / Destra / Derecha

NA = Non Attribué / Not Available / Nicht verfügbar / Non disponibile / No disponible

T = Tambour / Mechanical Drum / Strommel / Tamburo / Tambor



PIAGGIO

| | | | | | |
|----------------------------------------------|---------|---|------|-----|----------|
| PX 150 | 02 - | 1 | 3043 | MSC | T |
| GTX 180 Super Hexagon (Grimeca Caliper) 11' | 00 - | 1 | 3031 | MSC | 3054 MSC |
| GTX 180 Super Hexagon (Hengtong Caliper) 11' | 00 - | 1 | 3060 | MSC | 3054 MSC |
| GTX 180 Super Hexagon (Hengtong Caliper) 12' | 01 - | 1 | 3060 | MSC | 3054 MSC |
| LX 180 | 98 - 99 | 1 | 3031 | MSC | T |
| LXT 180 Hexagon | 99 - | 1 | 3031 | MSC | T |
| 180 X9 | 02 - | 2 | 3057 | MSC | 3057 MSC |
| 200 Beverly (Hengtong Caliper) | 02 - 06 | 1 | 3060 | MSC | 3060 MSC |
| 200 Beverly (Grimeca Caliper) | 02 - 06 | 1 | 3031 | MSC | 3031 MSC |
| 200 Carnaby | 08 - | 1 | 3060 | MSC | 3060 MSC |
| 200 Liberty | 06 - | 1 | 3043 | MSC | T |
| BV 200 | 02 - 04 | 1 | 3060 | MSC | 3060 MSC |
| BV 200 | 05 - | 1 | 3060 | MSC | 3031 MSC |
| GT 200 L | 04 - | 2 | 3060 | MSC | 3054 MSC |
| PX 200 | 02 - | 1 | 3043 | MSC | T |
| LXT 200 | 98 - | 1 | 3031 | MSC | T |
| 200 X8 | 04 | 2 | 3060 | MSC | 3057 MSC |
| 200 X8 | 05 - | 2 | 3060 | MSC | 3084 MSC |
| 200 X9 | 03 - | 2 | 3057 | MSC | 3057 MSC |
| 250 Beverly | 07 - | 1 | 3060 | MSC | 3060 MSC |
| BV 250 | 06 - | 1 | 3060 | MSC | 3060 MSC |
| 250 GT 60 | 06 - | 1 | 3060 | MSC | T |
| 250 LX 60 | 06 - | 1 | 3043 | MSC | T |
| 250 MP3 ie / LT | 06 - 09 | 2 | 3043 | MSC | 3084 MSC |
| LX4 250 Hexagone | 98 - 99 | 1 | 3031 | MSC | T |
| 250 X7 | 08 - | 1 | 3060 | MSC | 3077 MSC |
| 250 X8 | 05 - | 2 | 3060 | MSC | 3084 MSC |
| 250 X9 | 00 - 04 | 2 | 3057 | MSC | 3057 MSC |
| 250 X9 | 05 - L | 1 | 3060 | MSC | 3084 MSC |
| 250 X9 | 05 - R | 1 | 3077 | MSC | |
| 250 Xevo | 08 - | 1 | 3060 | MSC | 3077 MSC |
| GT 250 Hexagon | 99 - | 1 | 3031 | MSC | T |
| GTS 250 ABS | 06 - | 1 | 3060 | MSC | 3054 MSC |
| GTV 250 | 08 - | 1 | 3060 | MSC | 3084 MSC |
| GTX 250 Super Hexagon | 01 - | 1 | 3031 | MSC | 3054 MSC |
| 300 Beverly Tourer | 07 - | 1 | 3060 | MSC | 3060 MSC |
| 300 Carnaby Cruiser | 10 - | 1 | 3060 | MSC | 3060 MSC |
| 300 MP3 LT | 10 - | 2 | 3043 | MSC | 3077 MSC |
| GTS 300 Super | 09 - | 1 | 3060 | MSC | 3054 MSC |
| X7 300 ie | 10 - | 1 | 3060 | MSC | 3077 MSC |
| 400 Beverly ie | 07 - | 1 | 3028 | MSC | 3060 MSC |
| 400 Beverly Tourer | 08 - 09 | 1 | 3057 | MSC | 3057 MSC |
| 400 MP3 ie | 07 - | 2 | 3043 | MSC | 3084 MSC |
| 400 MP3 LT | 09 - | 2 | 3043 | MSC | 3084 MSC |
| 400 X8 | 07 - L | 1 | 3060 | MSC | 3060 MSC |
| 400 X8 | 07 - R | 1 | 3077 | MSC | |
| 400 Xevo | 08 - L | 1 | 3060 | MSC | 3060 MSC |
| 400 Xevo | 08 - R | 1 | 3077 | MSC | |
| 500 Beverly | 02 - 05 | 2 | 3057 | MSC | 3057 MSC |
| 500 Beverly | 06 | 2 | 3057 | MSC | 3084 MSC |
| 500 Beverly Cruiser | 07 - 09 | 2 | 3057 | MSC | 3057 MSC |
| 500 MP3 ie | 09 - 10 | 2 | 3043 | MSC | 3077 MSC |
| 500 X9 | 00 - 02 | 2 | 3057 | MSC | 3057 MSC |
| 500 X9 Evo | 03 - 06 | 2 | 3028 | MSC | 3057 MSC |
| 500 X9 Evo ABS | 04 - | 2 | 3028 | MSC | 3057 MSC |
| BV 500 | 06 - | 2 | 3057 | MSC | 3057 MSC |

RIEJU

| | | | | | |
|---------------------|----|---|------|-----|---|
| 125 Pacific (4T) | 08 | 1 | 3047 | MSC | T |
| 125 Pacific Scooter | 09 | 1 | 3047 | MSC | T |

SACHS

| | | | | | |
|------------------|---------|---|------|-----|----------|
| 125 Bee | 08 - 09 | 1 | 3008 | MSC | T |
| 125 Madass | 05 | 1 | NA | | NA |
| 125 Madass (4T) | 06 - 09 | 1 | NA | | 3018 MSC |
| 125 Speedjet RS | 10 | 1 | 3047 | MSC | 3043 MSC |
| 400 Quattrocento | 08 | 2 | 3003 | MSC | 3043 MSC |

SHE-LUNG

| | | | | | |
|----------|------|---|------|-----|---|
| 125 Mars | 97 - | 1 | 3029 | MSC | T |
|----------|------|---|------|-----|---|

SIAMOTO

| | | | | | |
|-------------|------|---|------|-----|---|
| 125 BD / KD | 02 - | 1 | 3069 | MSC | T |
|-------------|------|---|------|-----|---|

SIMSON

| | | | | | |
|-------------|------|---|------|-----|----------|
| 125 Schikra | 99 - | 1 | 3021 | MSC | 3013 MSC |
| 125 Star | 99 - | 1 | 3015 | MSC | T |

SULA

| | | | | | |
|------------------|------|---|------|-----|---|
| 125 Thunder Bird | 99 - | 1 | 3022 | MSC | T |
|------------------|------|---|------|-----|---|

SUZUKI

| | | | | | |
|------------------------------------------|-----------|---|------|-----|----------|
| AN 125 R / Vecstar | 94 - | 1 | 3051 | MSC | T |
| AN 125 S / T / V / W / X | 95 - 00 | 1 | 3051 | MSC | T |
| AN 125 HKK5 | 06 - 08 | 1 | 3022 | MSC | T |
| CS 125 LIDO | 90 - | 1 | 3022 | MSC | T |
| FL 125 SD / Address / Underbone | 07 - 10 | 1 | 3062 | MSC | T |
| FX 125 | | 1 | 3062 | MSC | T |
| UC 125 Epicuro | 99 - 02 | 1 | 3051 | MSC | T |
| UE 125 CTK1 | 01 - 03 | 1 | 3022 | MSC | T |
| UH 125 Burgman | 02 - 06 | 1 | 3028 | MSC | 3057 MSC |
| UH 125 Burgman | 07 - | 1 | 3082 | MSC | 3090 MSC |
| UX 125 SIXteen | 08 - | 1 | 3082 | MSC | 3090 MSC |
| UZ 125 (CF46A) V125G | 05 - | 1 | 3051 | MSC | T |
| AN 150 | 98 - | 1 | 3051 | MSC | T |
| UC 150 Epicuro | 99 - | 1 | 3051 | MSC | T |
| UE 150 CTK1 | 02 - | 1 | 3022 | MSC | T |
| UH 150 Burgman | 04 - 06 | 1 | 3028 | MSC | 3057 MSC |
| UX 150 SIXteen | 08 - | 1 | 3082 | MSC | 3090 MSC |
| UH 200 Burgman | 07 - | 1 | 3082 | MSC | 3090 MSC |
| AN 250 Vecstar | 94 - | 1 | 3051 | MSC | T |
| AN 250 Burgman / Skywave | 98 - 03 | 1 | 3049 | MSC | 3073 MSC |
| AN 250 Burgman / Skywave | 04 - 06 | 1 | 3049 | MSC | 3074 MSC |
| AN 250 Burgman / Skywave Type M / S / SS | 07 - 08 L | 1 | 3087 | MSC | 3066 MSC |
| AN 250 Burgman / Skywave Type M / S / SS | 07 - 08 R | 1 | 3086 | MSC | |
| AN 400 Burgman / Skywave | 99 - 00 | 1 | 3049 | MSC | 3073 MSC |
| AN 400 Burgman / Skywave | 01 - 06 | 1 | 3049 | MSC | 3074 MSC |
| AN 400 Burgman / Skywave | 07 - L | 1 | 3087 | MSC | 3066 MSC |
| AN 400 Burgman / Skywave | 07 - R | 1 | 3086 | MSC | |
| AN 650 Burgman / Skywave | 03 - 09 | 2 | 3065 | MSC | 3066 MSC |

SYM

| | | | | | |
|--------------------------|---------|---|------|-----|----------|
| GTS 125 Joymax / Voyager | 06 - 09 | 1 | 3092 | MSC | 3092 MSC |
| RS 125 | 04 - 06 | 1 | 3067 | MSC | 3062 MSC |
| RS21125 / R | 02 - | 1 | 3067 | MSC | T |
| 125 Aero Wolf | | 1 | 3009 | MSC | T |
| 125 Attila | 95 - | 1 | 3039 | MSC | T |
| 125 Citycom | 08 - | 1 | 3039 | MSC | 3092 MSC |
| 125 Euro MX (Euro 1) | 02 - 07 | 1 | 3067 | MSC | T |
| 125 Euro MX (Euro 2) | 06 - 09 | 1 | 3067 | MSC | 3062 MSC |
| 125 Fiddle II | 08 - | 1 | 3039 | MSC | T |
| 125 Jet 4 (4T) | 10 - | 1 | 3039 | MSC | T |
| 125 Orbit | 08 - 09 | 1 | 3038 | MSC | T |
| HD 125 | 04 - 07 | 1 | 3068 | MSC | T |
| HD 125 S Evo | 07 - | 1 | 3039 | MSC | T |
| HD 125 Evo i | 07 - 10 | 1 | 3039 | MSC | 3092 MSC |
| 125 Joyride | 01 - 06 | 1 | 3067 | MSC | 3068 MSC |
| 125 Joyride i | 07 - 09 | 1 | 3067 | MSC | 3092 MSC |
| 125 Joyride Evo i | 09 - 10 | 1 | 3067 | MSC | 3092 MSC |
| 125 Megalo | 00 - 07 | 1 | 3039 | MSC | T |
| 125 New Duke | 02 - | 1 | 3039 | MSC | T |
| 125 Shark | 99 - 02 | 1 | 3067 | MSC | T |
| 125 Shark R | 00 - 02 | 1 | 3067 | MSC | 3062 MSC |
| 125 SK | 03 - 04 | 1 | 3067 | MSC | 3068 MSC |
| 125 Super Duke | 99 - 02 | 1 | 3039 | MSC | T |
| 125 Symphony (4T) | 09 - | 1 | 3039 | MSC | T |
| 125 Symply | 07 - 09 | 1 | 3039 | MSC | T |
| VS 125 | 06 - 09 | 1 | 3067 | MSC | T |
| VS 150 | 06 - 08 | 1 | 3067 | MSC | T |
| HO1 150 | 95 - | 1 | 3039 | MSC | T |
| RS 150 | 05 - | 1 | 3067 | MSC | 3062 MSC |
| 150 Attila | 00 - | 1 | 3039 | MSC | T |
| 150 Euro MX | 03 - | 1 | 3067 | MSC | T |
| 150 Joyride | 01 - 06 | 1 | 3067 | MSC | 3068 MSC |
| 150 Shark | 99 - 02 | 1 | 3067 | MSC | T |
| 150 Shark R | 00 - 02 | 1 | 3067 | MSC | 3062 MSC |
| 150 Super Duke | 99 - 02 | 1 | 3039 | MSC | T |
| 200 HD | 04 - 07 | 1 | 3068 | MSC | T |
| 200 HD Evo | 07 - | 1 | 3039 | MSC | 3092 MSC |
| 200 HD Evo i | 07 - 09 | 1 | 3039 | MSC | 3092 MSC |
| 200 Joyride | 03 - 07 | 1 | 3067 | MSC | 3068 MSC |
| 200 Joyride i | 07 - 09 | 1 | 3067 | MSC | 3092 MSC |
| 200 Joyride Evo i | 09 - 10 | 1 | 3067 | MSC | 3092 MSC |
| GTS 250 JoyMax | 06 | 2 | 3070 | MSC | 3092 MSC |
| GTS 250 JoyMax i | 07 - 09 | 1 | 3070 | MSC | 3092 MSC |
| GTS 250 Voyager | 05 | 2 | 3070 | MSC | 3061 MSC |
| GTS 300 | 08 - 09 | 2 | 3070 | MSC | 3092 MSC |
| GTS 300 Citycom i | 08 - 09 | 2 | 3039 | MSC | 3092 MSC |

1 - 2 - 4 = Nombre de jeux / Number of sets / Anzahl Sets Numero blister / Numero des juegos

L = Gauche / Left / Links / Sinistra / Izquierda

R = Droite / Right / Rechts / Destra / Derecha

NA = Non Attribué / Not Available / Nicht verfügbar / Non disponibile / No disponible

T = Tambour / Mechanical Drum / Strommel / Tamburo / Tambor



SYM

| | | | | | | |
|----------------------|------|---|------|-----|------|-----|
| GTS 300 Joymax Evo i | 09 - | 2 | 3070 | MSC | 3092 | MSC |
| GT 500 | 04 - | 2 | 3049 | MSC | 3068 | MSC |

TGB

| | | | | | | |
|------------------------|---------|---|------|-----|------|-----|
| 125 Delivery / Express | 04 - 09 | 1 | NA | | T | |
| 125 X-Motion | 08 - | 1 | NA | | 3092 | MSC |
| 125 X-Bullet R | 08 - | 1 | NA | | 3022 | MSC |
| 125 204 Classic | 03 - 04 | 1 | 3022 | MSC | T | |
| 125 303 Revolution | 02 - 03 | 1 | 3022 | MSC | T | |
| 125 303 R Hawk / Laser | 04 - 08 | 1 | NA | | T | |
| 125 304 Sport | 03 - 09 | 1 | NA | | T | |
| 125 404 Executive | 03 - 04 | 1 | NA | | T | |
| 125 F409 | 02 - 05 | 1 | 3022 | MSC | T | |
| 150 303 R Hawk / Laser | 04 - 08 | 1 | NA | | T | |
| 250 Dynasty | 06 - | 1 | 3078 | MSC | 3029 | MSC |
| 250 X-Motion i | 08 - | 1 | NA | | 3092 | MSC |

YAMAHA

| | | | | | | |
|-------------------------|---------|---|------|-----|------|-----|
| VP 125 X-City | 08 - | 1 | 3059 | MSC | 3057 | MSC |
| XC 125 Cygnus | 96 - 03 | 1 | 3008 | MSC | T | |
| XC 125 Vity | 08 - | 1 | 3099 | MSC | T | |
| XN 125 Teos | 00 - 03 | 1 | 3013 | MSC | T | |
| XQ 125 Maxster | 01 - 03 | 1 | 3028 | MSC | 3057 | MSC |
| YP 125 BLACK X-Max | 09 - | 1 | 3085 | MSC | 3057 | MSC |
| YP 125 Majesty | 98 - 00 | 1 | 3028 | MSC | T | |
| YP 125 Majesty | 01 - 09 | 1 | 3028 | MSC | 3057 | MSC |
| YP 125 R X-Max | 06 - 09 | 1 | 3085 | MSC | 3057 | MSC |
| YP 125 R X-Max | 10 - | 1 | 3097 | MSC | 3057 | MSC |
| YP 125 R X-Max ABS | 11 - | 1 | 3097 | MSC | 3095 | MSC |
| YW 125 Z (BWS 125) | 10 - | 1 | 3098 | MSC | T | |
| XC 150 Fly One R | 98 - | 1 | 3008 | MSC | T | |
| XN 150 Teos | 02 - | 1 | 3013 | MSC | T | |
| XQ 150 Maxter | 01 - | 1 | 3028 | MSC | 3057 | MSC |
| YP 150 Majesty | 01 - | 1 | 3028 | MSC | 3057 | MSC |
| YP 180 R Majesty | 04 - | 1 | 3028 | MSC | 3057 | MSC |
| YP 180 R Majesty | 03 | 1 | 3028 | MSC | T | |
| CP 250 Maxam / Morphus | 05 - 08 | 1 | 3025 | MSC | 3075 | MSC |
| YP 250 Majesty | 96 - 98 | 1 | 3025 | MSC | T | |
| YP 250 Majesty DX / ABS | 98 - 99 | 1 | 3025 | MSC | 3033 | MSC |
| YP 250 Majesty | 99 - 03 | 1 | 3025 | MSC | 3033 | MSC |
| VP 250 X-City | 07 - | 1 | 3059 | MSC | 3033 | MSC |
| YP 250 R X-Max | 05 - 09 | 1 | 3085 | MSC | 3033 | MSC |
| YP 250 R X-Max | 10 - | 1 | 3059 | MSC | 3033 | MSC |
| XC 300 Versity | 03 - 05 | 1 | 3028 | MSC | 3028 | MSC |
| XC 300 Versity | 06 - | 1 | 3059 | MSC | 3028 | MSC |
| YP 400 Majesty | 04 | 1 | 3058 | MSC | 3075 | MSC |
| YP 400 Majesty | 05 - | 2 | 3025 | MSC | 3075 | MSC |
| XP 500 T-Max (N/P/R) | 01 - 03 | 1 | 3058 | MSC | 3061 | MSC |
| XP 500 T-Max (S/T/V) | 04 - 07 | 2 | 3025 | MSC | 3075 | MSC |
| XP 500 T-Max (4B5) | 08 - | 2 | 3091 | MSC | 3075 | MSC |

1-2-4 = Nombre de jeux / Number of sets / Anzahl Sets Numero blister / Numero des juegos

L = Gauche / Left / Links / Sinistra / Izquierda

R = Droite / Right / Rechts / Destra / Derecha

NA = Non Attribué / Not Available / Nicht verfügbar / Non disponibile / No disponible

T = Tambour / Mechanical Drum / Strommel / Tamburo / Tambor

Buyers guide

STREET
CALIPERS
RACING
OFF ROAD
ATV

Légende Legend

| Street | Sport | Racing | Enduro | MX | Off Road Racing | ATV |
|--------|-------|--------|--------|----|--------------------|-----|
|--------|-------|--------|--------|----|--------------------|-----|

Applications
Applications

S4 A3+ XBK5 C59

▲ Nuances disponibles
▲ Available compounds

Année
Year
▼
Avant
Front
▼
Arrière
Rear
▼

| | | | | | | |
|-----------------|---------------|---------|-----|---|--|--|
| KAWASAKI | | | | | | |
| ZX9-R | 900 Ninja | 02 - 03 | 2 | ● | | |
| Z | 1000 | 03 - 06 | 2 | ● | | |
| KAWASAKI | | | | | | |
| ZX10-R | 1000 Ninja | 04 - | | ● | | |
| SUZUKI | | | | | | |
| GSF | 600 Bandi N/S | 01 - 05 | L 1 | ● | | |
| GSF | 600 Bandi N/S | 01 - 05 | R 1 | ● | | |

Gauche / Left
ou / or
Droit / Right

Nombre
de jeux
Number
of sets

2361

Référence
Reference

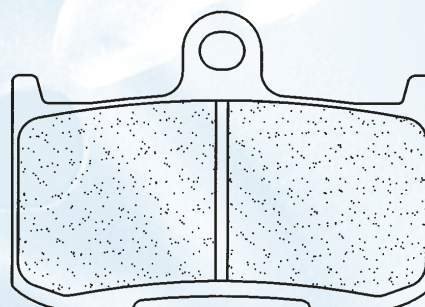

Dessin de
la plaquette -
Taille réelle
Pad drawing
- Real size

Dim./Size

| | | |
|---|----------------|-------------------------|
| → | 69,4 mm | ◀ Largeur / Width |
| ↑ | 50,9 mm | ◀ Hauteur / Height |
| H | 8,7 mm | ◀ Epaisseur / Thickness |

Street Sport Racing Enduro MX Off Road ATV Racing

A3+ XBK5 C59

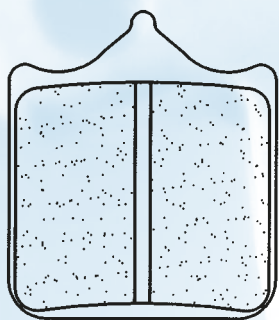

Dim./Size
35 mm
40,5 mm
7,5 mm

1033

APRILIA

| | | | |
|----------|-------------------|-----------|---|
| RSV 1000 | | 02 - 2 | ● |
| RSV 1000 | Factory Pista | 04 - 2 | ● |
| RSV 1000 | Nera | 04 - 2 | ● |
| RSV 1000 | R | 01 - 02 2 | ● |
| RSV 1000 | R | 03 - 2 | ● |
| RSV 1000 | R Factory Replica | 04 - 2 | ● |
| RSV 1000 | Tuono Fighter | 03 - 05 2 | ● |

BENELLI

| | | | |
|----------|----------------------------|-----------|---|
| BX 449 | Supermotard | 08 - 1 | ● |
| 2ue 756 | Cue | 07 - 09 2 | ● |
| 900 | Tornado Tre | 03 - 2 | ● |
| 900 | Tornado Tre RS (Rad. cal.) | 04 - 2 | ● |
| TNT 1130 | Café Racer | 05 - 2 | ● |
| TNT 1130 | Officine | 07 - 2 | ● |
| TNT 1130 | Sport / Titanium | 05 - 2 | ● |
| 1130 | Tornado | 08 - 2 | ● |

BIMOTA

| | | | |
|-----------|-------------|--------|---|
| DB5 1000 | Mille | 05 - 2 | ● |
| DB5 1000 | R | 07 - 2 | ● |
| DB5 1000 | S | 07 - 2 | ● |
| DB6 1000 | Delirio | 07 - 2 | ● |
| SB8K 1000 | Santamonica | 07 - 2 | ● |
| DB7 1098 | (Rad. Cal) | 08 - 2 | ● |
| 3D 1100 | Tesi | 07 - 2 | ● |
| DB6R 1100 | Delirio | 08 - 2 | ● |

BMW

| | | | |
|-------|-----|--------|---|
| G 450 | SMR | 09 - 1 | ● |
|-------|-----|--------|---|

BREMBO

| | | | |
|--|---------------------------------------|---|---|
| | P4 34x34 Gold - Road/Racing | 1 | ● |
| | P4 34x34 Radial Caliper - Road/Racing | 1 | ● |

CAGIVA

| | | | |
|------|-----------|--------|---|
| 1000 | X-Raptor | 03 - 2 | ● |
| 1000 | X3 Raptor | 04 - 2 | ● |

DERBI

| | | | |
|-----|---------------|--------|---|
| 659 | Mulhacén | 06 - 1 | ● |
| 659 | Mulhacén Cafe | 08 - 1 | ● |

DUCATI

| | | | |
|-----|----------------|-----------|---|
| 748 | R | 01 - 03 2 | ● |
| 749 | / S | 03 - 2 | ● |
| 749 | R / Dark | 04 - 2 | ● |
| 996 | R | 01 2 | ● |
| 998 | Monster S4RS | 06 2 | ● |
| 998 | R | 02 2 | ● |
| 999 | Monster S4R/RS | 07 - 08 2 | ● |

DUCATI

| | | | |
|------|--------------------------|--------|---|
| 999 | / S / R | 03 - 2 | ● |
| 999 | RS | 04 - 2 | ● |
| 999 | R Xerox | 06 - 2 | ● |
| 1000 | Hypermotard | 06 - 1 | ● |
| 1000 | Monster S4Rs Testatretta | 06 - 2 | ● |

GILERA

| | | | |
|-----|------------|--------|---|
| 600 | Supersport | 03 - 2 | ● |
|-----|------------|--------|---|

HUSQUEVARNA

| | | | |
|---------|--------|-----------|---|
| SM 450 | R | 05 1 | ● |
| SM 450 | R / RR | 06 - 08 1 | ● |
| SM 450 | R | 09 - 1 | ● |
| SM 510 | R | 06 1 | ● |
| SM 610 | | 06 1 | ● |
| SM 630 | | 10 - 1 | ● |
| STR 650 | CRC | 07 - 1 | ● |

HYOSUNG

| | | | |
|--------|----|--------|---|
| RX 450 | SM | 08 - 1 | ● |
|--------|----|--------|---|

KTM

| | | | |
|-----|---------------|-----------|---|
| 690 | SMC | 08 - 10 1 | ● |
| 690 | SMR | 07 - 09 1 | ● |
| 690 | Duke | 08 - 1 | ● |
| 690 | Duke R | 10 - 1 | ● |
| 950 | Duke | 03 - 2 | ● |
| 950 | SM | 05 - 2 | ● |
| 950 | SMR | 07 2 | ● |
| 990 | Supermoto / R | 07 - 2 | ● |
| 990 | Super moto T | 09 - 2 | ● |
| 990 | Super Duke | 05 - 2 | ● |
| 990 | Super Duke R | 09 - 2 | ● |

LAVERDA

| | | | |
|----------|------------|--------|---|
| SFC 1000 | (Rad.cal.) | 04 - 2 | ● |
|----------|------------|--------|---|

MONDIAL

| | | | |
|------|-------------------------|--------|---|
| 1000 | Evo (Rad. Cal.) | 04 - 2 | ● |
| 1000 | Piega | 03 - 2 | ● |
| 1000 | RZ Nuda | 04 - 2 | ● |
| 1000 | Starfighter (Rad. Cal.) | 04 - 2 | ● |

MOTO GUZZI

| | | | |
|------|--------------|--------|---|
| 1200 | Corsa MGS-01 | 07 - 2 | ● |
|------|--------------|--------|---|

MOTO MORINI

| | | | |
|------|-----------|------|---|
| 1200 | Granferro | 10 2 | ● |
|------|-----------|------|---|

MV AGUSTA

| | | | |
|------|--------------------|-----------|---|
| 910 | Brutale R (Brembo) | 05 - 08 2 | ● |
| 1000 | F4 Senna | 06 2 | ● |
| 1000 | F4 R (Brembo) | 06 - 07 2 | ● |
| 1000 | F4 RR 312 (Brembo) | 07 2 | ● |

NORTON

| | | | |
|-----|---------------------|------|---|
| 961 | Commando Café Racer | 10 2 | ● |
|-----|---------------------|------|---|

SHERCO

| | | | |
|-----|---------------------------|-----------|---|
| 450 | SM 4.5i F (Black Panther) | 08 - 10 1 | ● |
| 510 | SM 5.1i F Black Panther | 08 - 10 1 | ● |

TM

| | | | |
|---------|------------------|-----------|---|
| SMM 125 | Black Dream (2T) | 08 - 10 1 | ● |
| SMM 250 | F (4T) | 10 1 | ● |
| SMR 250 | F (4T) | 10 1 | ● |
| SMM 450 | F Black Dream ES | 08 - 10 1 | ● |
| SMR 450 | F (4T) | 10 1 | ● |
| SMX 450 | F | 05 - 10 1 | ● |
| SMM 530 | F Black Dream ES | 08 - 10 1 | ● |
| SMR 530 | F | 10 1 | ● |
| SMX 530 | F | 05 - 10 1 | ● |
| SMX 660 | F | 05 - 10 1 | ● |

TRIUMPH

| | | | |
|------|-------------------------------|-----------|---|
| 1050 | Speed Triple (Brembo Rad.Cal) | 08 - 10 2 | ● |
| 1050 | Speed Triple (Brembo Rad.Cal) | 11 - 2 | ● |

VOXAN

| | | | |
|------|----------------|--------|---|
| 1000 | Charade Racing | 06 2 | ● |
| 1200 | GTV | 08 - 2 | ● |

Street Sport Racing Enduro MX Off Road ATV Racing

MX10

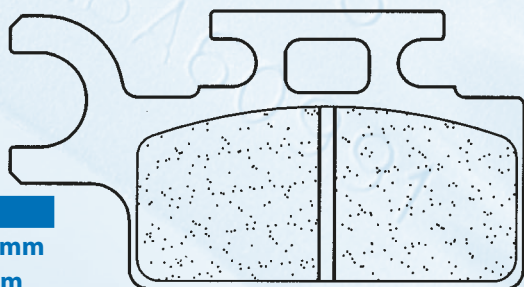

Dim./Size
67,6 mm
35 mm
7,5 mm

1034

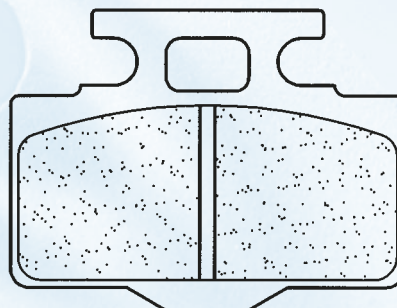

Dim./Size
51,8 mm
40 mm
7,5 mm

KAWASAKI

| | | | |
|-------|--|--------|---|
| KX 65 | | 00 - 1 | ● |
|-------|--|--------|---|

SUZUKI

| | | | |
|-------|--|-----------|---|
| RM 65 | | 03 - 05 1 | ● |
|-------|--|-----------|---|

Street Sport Racing Enduro MX Off Road **ATV Racing**

RX3

YAMAHA

| | | | | |
|-----|------|-------|---------|---|
| XJR | 400 | | 02 - | ● |
| FZS | 1000 | Fazer | 01 - 05 | ● |
| XJR | 1300 | | 02 - 10 | ● |

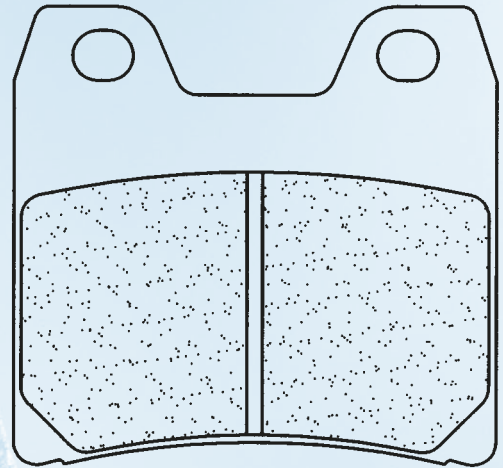

Dim./Size

← **63,4 mm**
↑↓ **60,3 mm**
H **8,7 mm**

1066

Street Sport Racing Enduro MX Off Road **ATV Racing**

S4 RX3

HONDA

| | | | | |
|-----|-----|----------|------|---|
| CBR | 125 | R | 04 - | ● |
| XLV | 125 | Varadero | 01 - | ● |
| CBR | 150 | R | 00 - | ● |



1067

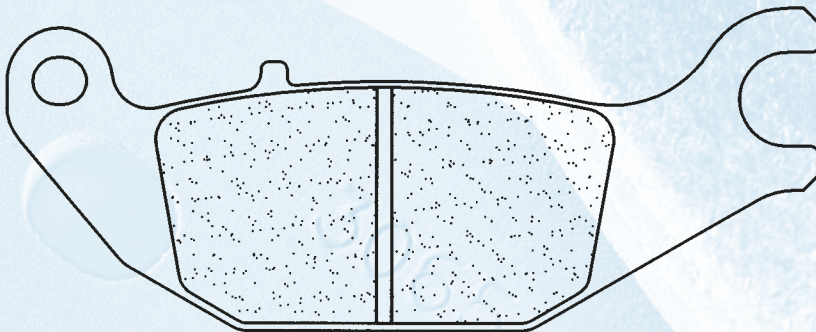
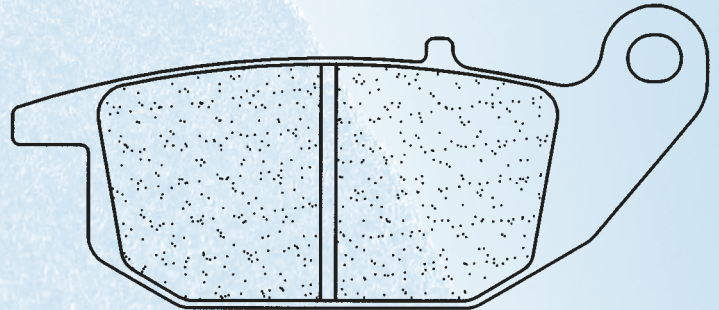

Dim./Size

← **91,5 mm**
↑↓ **40 mm**
H **10 mm**

Dim./Size

← **107,2 mm**
↑↓ **42,7 mm**
H **10 mm**

Street Sport Racing Enduro MX Off Road **ATV Racing**

C59

PVM

Radial Caliper - Racing



2 ●

1075



Dim./Size

← **43,2 mm**
↑↓ **48,7 mm**
H **10 mm**

Street Sport Racing Enduro MX Off Road ATV Racing

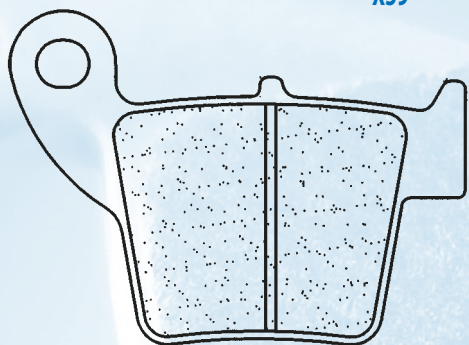

X59

Dim./Size

→ **60 mm**
↑ **43,2 mm**
H **9,6 mm**

1076

APRILIA

| | | | | |
|-----|-----|-----------------|---------|---|
| MXV | 450 | | 09 - | ● |
| HM | | | | ● |
| CR | 125 | X Supermotard | 04 - 06 | ● |
| CRM | 125 | X Supermotard | 07 | ● |
| CRF | 250 | Supermotard | 04 - 06 | ● |
| CRM | 250 | X Supermotard | 07 - | ● |
| CRF | 450 | R Supermotard | 02 - 06 | ● |
| CRM | 450 | F Supermotard R | 07 - 08 | ● |
| CRM | 450 | F Supermotard X | 07 | ● |
| CRM | 490 | F Supermotard X | 07 | ● |
| CRE | 125 | Enduro | 02 - 07 | ● |
| CRF | 230 | Enduro / Trial | 04 - 07 | ● |
| CRE | 250 | R Enduro | 02 - 07 | ● |
| CRF | 250 | F | 04 - 08 | ● |
| CRE | 450 | F | 02 | ● |
| CRE | 450 | R Enduro | 02 - 07 | ● |
| CRE | 450 | F / X | 04 - 07 | ● |
| CRF | 450 | R Enduro | 04 - 08 | ● |
| CRF | 450 | R | 04 - 08 | ● |
| CRE | 490 | X | 07 | ● |

HONDA

| | | | | |
|-----|-----|-------|---------|---|
| CR | 125 | R | 02 - | ● |
| CRE | 125 | | 02 - | ● |
| CR | 250 | R | 02 - | ● |
| CRE | 250 | | 02 - 03 | ● |
| CRE | 250 | F | 04 - | ● |
| CRF | 250 | R Efi | 04 - 09 | ● |
| CRF | 250 | X | 04 - 09 | ● |
| CRE | 450 | F | 02 - | ● |
| CRF | 450 | R | 02 - 08 | ● |
| CRF | 450 | R Efi | 09 - | ● |
| CRF | 450 | X | 05 - | ● |

SUZUKI

| | | | | |
|-----|----|--|------|---|
| RME | 50 | | 10 - | ● |
|-----|----|--|------|---|

Street Sport Racing Enduro MX Off Road ATV Racing

1078

MX10 X59

Dim./Size

→ **62 mm**
↑ **31,4 mm**
H **6,3 mm**

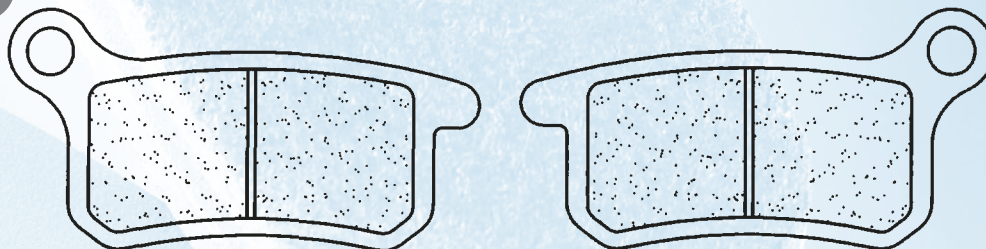

KTM

| | | | | |
|----|----|--|-----------|---|
| SX | 65 | | 02 - 03 1 | ● |
| SX | 65 | | 04 - 08 1 | ● |
| SX | 65 | | 09 - 1 | ● |
| SX | 85 | | 03 - 10 1 | ● |
| SX | 85 | | 11 - 1 | ● |

Street Sport Racing Enduro MX Off Road Racing ATV

A3+ XBK5 C59

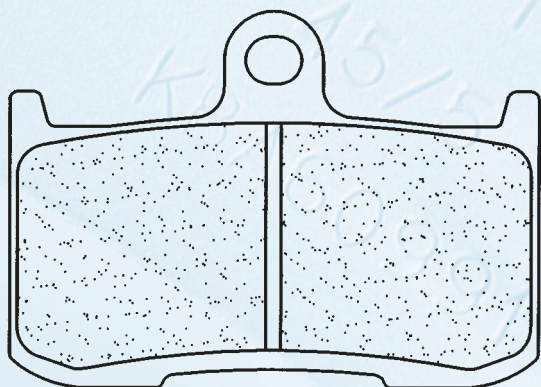

1083

Dim./Size

→ **67,4 mm**
↑ **49,6 mm**
H **7 mm**

KAWASAKI

| | | | | |
|-------|------|-------|-----------|---|
| ZX9-R | 900 | Ninja | 02 - 03 2 | ● |
| Z | 1000 | | 03 - 06 2 | ● |

NISSIN

| | | |
|---------------------------------------|---|---|
| 4 Piston Radial Caliper - Road/Racing | 1 | ● |
|---------------------------------------|---|---|

SUZUKI

| | | | | |
|-----|------|--------|--------|---|
| GSX | 1340 | B-king | 08 - 2 | ● |
|-----|------|--------|--------|---|

TRIUMPH

| | | | |
|------|-------------------------------|-----------|---|
| 675 | Daytona (Rad.cal) | 06 - 08 2 | ● |
| 675 | Street Triple R | 09 - 2 | ● |
| 1050 | Speed Triple (Nissin Rad.Cal) | 05 - 07 2 | ● |
| 1050 | Tiger | 07 - 2 | ● |
| 1050 | Tiger SE (ABS) | 09 - 2 | ● |

VICTORY

| | | | | |
|---------------|------|---------------------|-----------|---|
| Kingpin | 1634 | 8-Ball / Low / Tour | 08 - 10 1 | ● |
| Vegas | 1634 | Cory Ness Jackpot | 08 - 10 1 | ● |
| Vegas | 1634 | / Low | 08 - 10 1 | ● |
| Vegas | 1634 | 8-Ball | 08 - 10 1 | ● |
| Cross Country | 1731 | | 10 - 2 | ● |
| Cross Roads | 1731 | | 10 - 2 | ● |
| Hammer | 1731 | / S | 08 - 10 2 | ● |
| Hammer | 1731 | 8-ball | 10 - 2 | ● |
| Vegas | 1731 | | 08 - 10 1 | ● |
| Vegas | 1731 | Jackpot | 10 - 2 | ● |

Street Sport Racing Enduro MX Off Road Racing ATV

RX3

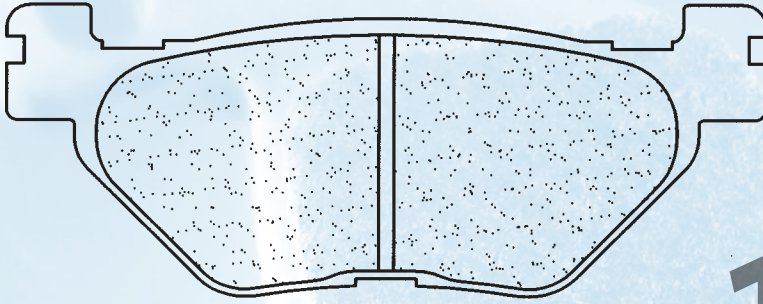

HYOSUNG

| | | | | |
|---------------|------|--------------------------|---------|---|
| GV | 650 | Aquila | 04 - 05 | ● |
| YAMAHA | | | | |
| TDM | 900 | | 02 - | ● |
| TDM | 900 | ABS | 05 - | ● |
| XVS | 950 | A Midnight Star | 09 - | ● |
| XT | 1200 | Z Super Ténéré (ABS/UBS) | 10 - | ● |
| FJR | 1300 | | 01 - 02 | ● |
| FJR | 1300 | / ABS | 03 - 05 | ● |
| FJR | 1300 | A / AS ABS | 06 - | ● |
| XVS | 1300 | A Midnight Star | 07 - | ● |
| XV | 1700 | A / PC Road Star | 02 - 05 | ● |
| XV | 1700 | Y V-Max | 09 - | ● |
| XV | 1900 | A Midnight Star | 06 - | ● |

1084

Dim./Size

→ 100 mm
↑ 38,5 mm
H 9,6 mm

Street Sport Racing Enduro MX Off Road Racing ATV

RX3

MX10 X59

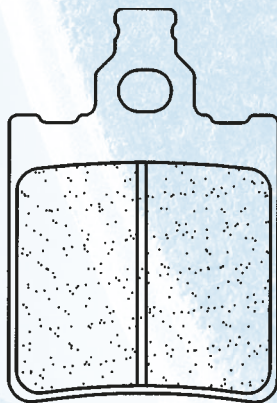

Dim./Size

→ 35,3 mm
↑ 51,5 mm
H 7 mm

1089

APRILIA

| | | | |
|-----|-------------|---------|---|
| 125 | Tuareg Wind | 88 | ● |
| 240 | Climber | 89 - 90 | ● |
| 275 | Climber | 89 - 90 | ● |

BETA

| | | | |
|-----|------------|---------|---|
| 350 | 4.0 Motard | 04 - | ● |
| ALP | 350 4.0 | 04 - 05 | ● |

CAGIVA

| | | | |
|-----|----------------|---------|---|
| 50 | Blues | 89 | ● |
| 50 | Cocis | 88 - | ● |
| 50 | Lucky Explorer | 88 - | ● |
| 80 | Cocis | 91 - | ● |
| 125 | Cruiser | 87 | ● |
| 125 | N90 | 91 - | ● |
| 125 | Tamanaco | 88 - 89 | ● |
| W8 | 125 / R | 94 - | ● |

FANTIC

| | | | |
|----|-------|------|---|
| 50 | Oasis | 90 - | ● |
| 75 | Oasis | 89 - | ● |

GARELLI

| | | | |
|-----|-----------|------|---|
| 125 | Tiger XLE | 86 - | ● |
|-----|-----------|------|---|

GILERA

| | | | |
|-----|-----|----|---|
| X 1 | 125 | 89 | ● |
|-----|-----|----|---|

JCM

| | | | |
|-----|--------|----|---|
| 325 | Europa | 89 | ● |
|-----|--------|----|---|

KEEWAY

| | | | |
|----|--------|------|---|
| TX | 125 SM | 10 - | ● |
|----|--------|------|---|

KTM

| | | | |
|----|----|---------|---|
| SX | 65 | 00 - 01 | ● |
| SX | 65 | 02 - 03 | ● |

MALAGUTI

| | | | |
|-----|----|--------|---|
| MDX | 50 | 86 - 1 | ● |
|-----|----|--------|---|

Street Sport Racing Enduro MX Off Road Racing ATV

A3+

XBK5

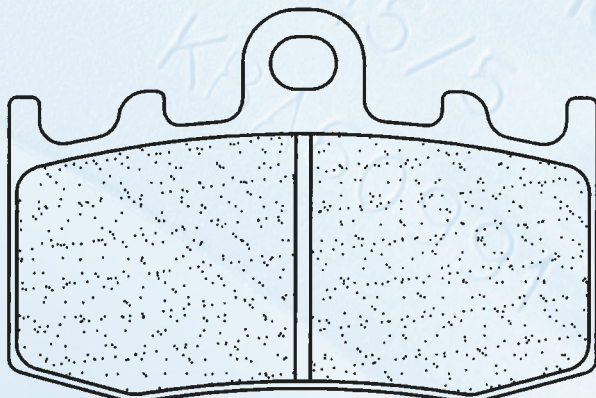

BMW

| | | | | |
|-----|------|--------------------|-----------|---|
| R | 850 | RT ABS | 01 - 2 | ● |
| R | 1100 | S (Brembo Caliper) | 01 - 2 | ● |
| R | 1150 | GS / GS Adventure | 02 - 2 | ● |
| R | 1150 | RT ABS | 01 - 2 | ● |
| HP2 | 1200 | Megamoto | 07 - 2 | ● |
| K | 1200 | GT ABS | 02 - 04 2 | ● |
| K | 1200 | GT ABS | 05 - 2 | ● |
| K | 1200 | LT ABS | 06 - 2 | ● |
| K | 1200 | RS | 02 - 2 | ● |
| K | 1200 | S | 05 - 2 | ● |
| R | 1200 | GS | 04 - 2 | ● |
| R | 1200 | R | 06 - 2 | ● |
| R | 1200 | RT | 05 - 2 | ● |
| R | 1200 | S | 05 - 2 | ● |
| R | 1200 | ST | 05 - 2 | ● |
| K | 1300 | GT | 09 - 2 | ● |
| K | 1300 | S | 09 - 2 | ● |

1101

Dim./Size

→ 77,2 mm
↑ 51,5 mm
H 8,5 mm

Street Sport Racing Enduro MX Off Road Racing ATV

X59 ATV1

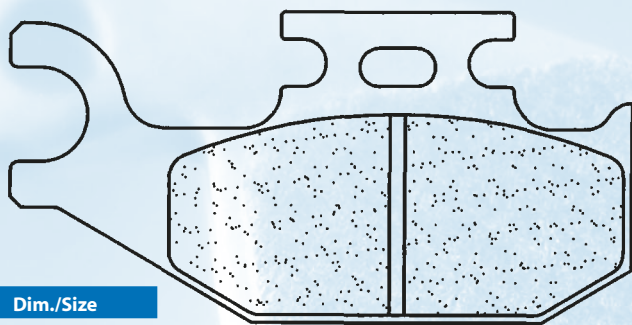

Dim./Size

82 mm
40,8 mm
9,5 mm

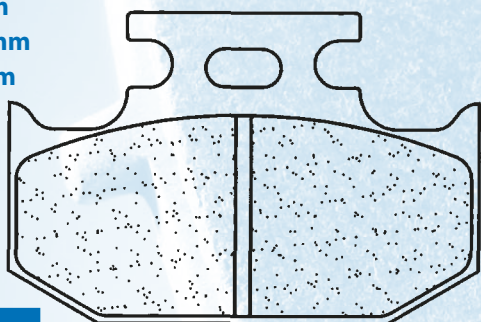

Dim./Size

62 mm
40,8 mm
9,5 mm

1102

BOMBARDIER

| | | | | | |
|-----|-----------------|------|---|---|---|
| 330 | Outlander | 03 - | R | 1 | ● |
| 400 | Outlander | 03 - | R | 1 | ● |
| 400 | Outlander Max | 03 - | R | 1 | ● |
| 500 | Quest | 02 - | R | 1 | ● |
| 500 | Traxter 4X4 | 02 - | R | 1 | ● |
| 500 | Traxter 4x4 Max | 02 - | R | 1 | ● |

Street Sport Racing Enduro MX Off Road Racing ATV

RX3

X59

Dim./Size

66,9 mm
36 mm
10,9 mm

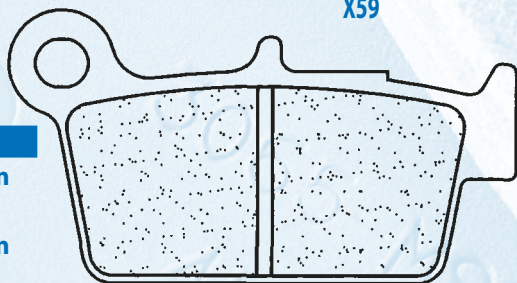

1103

APRILIA

| | | | | | |
|-----|-----|-------------------|------|--|---|
| SXV | 450 | | 06 - | | ● |
| SXV | 450 | Van den Bosh Rep. | 08 - | | ● |
| SXV | 550 | | 06 - | | ● |
| SXV | 550 | Van den Bosh Rep. | 08 - | | ● |
| SXV | 450 | | 06 - | | ● |
| SXV | 450 | Van den Bosh Rep. | 08 - | | ● |
| SXV | 550 | | 06 - | | ● |
| SXV | 550 | Van den Bosh Rep. | 08 - | | ● |
| RXV | 450 | Enduro | 06 - | | ● |
| RXV | 550 | Enduro | 06 - | | ● |

BETA

| | | | | | |
|----|-----|--------|------|--|---|
| RR | 250 | Enduro | 05 - | | ● |
| RR | 400 | Enduro | 05 - | | ● |
| RR | 450 | Enduro | 05 - | | ● |
| RR | 525 | Enduro | 05 - | | ● |

BOMBARDIER

| | | | | | |
|-----|--------------|------|---|---|---|
| 650 | DS | 01 - | R | 1 | ● |
| 650 | Quest | 02 - | R | 1 | ● |
| 650 | Quest Max | 02 - | R | 1 | ● |
| 650 | Traxter Max | 03 - | R | 1 | ● |
| 800 | Outlander | 06 - | R | 1 | ● |
| 800 | Outlander XT | 06 - | R | 1 | ● |

CAN-AM

| | | | | | |
|-----|-------------------|------|---|---|---|
| 400 | Outlander EFI | 09 - | R | 1 | ● |
| 400 | Outlander Max STD | 07 - | R | 1 | ● |
| 400 | Outlander STD | 07 - | R | 1 | ● |
| 400 | Outlander MAX XT | 07 - | R | 1 | ● |
| 400 | Outlander XT | 07 - | R | 1 | ● |
| 500 | Outlander Max STD | 07 - | R | 1 | ● |
| 500 | Outlander MAX XT | 07 - | R | 1 | ● |
| 500 | Outlander STD | 07 - | R | 1 | ● |
| 500 | Outlander XT | 07 - | R | 1 | ● |
| 500 | Renegade | 08 - | R | 1 | ● |
| 650 | Outlander Max STD | 07 - | R | 1 | ● |
| 650 | Outlander MAX XT | 07 - | R | 1 | ● |
| 650 | Outlander STD | 07 - | R | 1 | ● |
| 650 | Outlander XT | 07 - | R | 1 | ● |
| 800 | Outlander Max LTD | 07 - | R | 1 | ● |
| 800 | Outlander Max STD | 07 - | R | 1 | ● |
| 800 | Outlander MAX XT | 07 - | R | 1 | ● |
| 800 | Outlander STD | 07 - | R | 1 | ● |
| 800 | Outlander XT | 07 - | R | 1 | ● |
| 800 | Renegade Efi | 07 - | R | 1 | ● |
| 800 | Renegade | 08 - | R | 1 | ● |
| 800 | Renegade X | 08 - | R | 1 | ● |

CANNONDALE

| | | | | | |
|-----|----------|------|---|---|---|
| 440 | Blaze | 03 - | R | 1 | ● |
| 440 | Cannibal | 03 - | R | 1 | ● |
| 440 | Glamis | 03 - | R | 1 | ● |
| 440 | Moto | 03 - | R | 1 | ● |
| 440 | Speed | 03 - | R | 1 | ● |

SUZUKI

| | | | | | | |
|-------|-----|------------------|---------|---|---|---|
| KLT-A | 400 | King Quad | 08 - | L | 1 | ● |
| KLT-F | 400 | King Quad | 08 - | L | 1 | ● |
| LT-A | 400 | King Quad | 08 - | L | 1 | ● |
| LT-F | 400 | King Quad | 08 - | L | 1 | ● |
| LT-A | 450 | King Quad | 07 - | L | 1 | ● |
| LT-A | 500 | XPLO | 10 - | R | 1 | ● |
| LT-A | 700 | King Quad | 05 - 07 | R | 1 | ● |
| LT-A | 750 | King Quad | 08 - 09 | R | 1 | ● |
| LT-A | 750 | XPLO | 10 - | R | 1 | ● |
| LT-A | 500 | FK2 - FK7 Vinson | 02 - 07 | | 2 | ● |
| LT-A | 650 | FK2 Vinson | 02 - | | 2 | ● |

YAMAHA

| | | | | | | |
|-----|-----|----------|---------|---|---|---|
| YXR | 450 | Rhino | 06 - | L | 1 | ● |
| YXR | 660 | Rhino | 04 - 06 | L | 1 | ● |
| YFM | 700 | R Raptor | 06 - | L | 1 | ● |

KAWASAKI

| | | | | | |
|------|-----|-----|---------|--|---|
| KX-F | 250 | | 04 - | | ● |
| KLX | 450 | R | 07 - | | ● |
| KX-F | 450 | | 06 - 08 | | ● |
| KX-F | 450 | Efi | 09 - | | ● |

SHERCO

| | | | | | |
|-----|---------------------------------|---------|--|--|---|
| 250 | SM 2.5i Supermotard (4T) | 08 - | | | ● |
| 450 | SM 4.5i F (Supermotard) | 04 - 10 | | | ● |
| 450 | SM 4.5i F (Black Panther) | 08 - 10 | | | ● |
| 510 | SM 5.1i F Supermotard | 07 | | | ● |
| 510 | SM 5.1i F Black Panther | 08 - 10 | | | ● |
| 250 | Enduro 2.5i (4T) Inc. SE Models | 08 - 10 | | | ● |
| 250 | SX 2.5i F Moto Cross | 10 - | | | ● |
| 300 | Enduro SE 3.0i (4T) | 10 - | | | ● |
| 450 | Enduro 4.5i (4T) | 04 - 10 | | | ● |
| 510 | Enduro 5.1i F | 07 - 10 | | | ● |

SUZUKI

| | | | | | |
|------|-----|-----|---------|--|---|
| RM-E | 125 | | 05 - | | ● |
| RME | 250 | | 05 - | | ● |
| RM-Z | 250 | E | 04 - 09 | | ● |
| RM-Z | 250 | Efi | 10 - | | ● |
| RM-X | 450 | | 05 - | | ● |
| RM-Z | 450 | | 05 - 07 | | ● |
| RM-Z | 450 | Efi | 08 - | | ● |

YAMAHA

| | | | | | |
|----|-----|------------------------|---------|--|---|
| WR | 250 | R | 08 - | | ● |
| WR | 250 | X Supermotard | 08 - | | ● |
| YZ | 125 | R / S / T / V / W | 03 - 07 | | ● |
| YZ | 125 | X / Y / Z | 08 - | | ● |
| WR | 250 | FR/FS/FT/FV | 03 - 06 | | ● |
| WR | 250 | FW/FX/FY/FZ | 07 - | | ● |
| YZ | 250 | R / S / T / V / W (2T) | 03 - 07 | | ● |
| YZ | 250 | FR / FS / FT / FV (4T) | 03 - 06 | | ● |
| YZ | 250 | X / Y / Z (2T) | 08 - | | ● |
| YZ | 250 | FW / FX / FY / FZ (4T) | 07 - | | ● |
| WR | 450 | FR / FS / FT / FV (4T) | 03 - 06 | | ● |
| WR | 450 | FW / FX / FY / FZ (4T) | 07 - | | ● |
| YZ | 450 | FR / FS / FT / FV (4T) | 03 - 06 | | ● |
| YZ | 450 | FW (4T) | 07 | | ● |
| YZ | 450 | FX / FY / FZ (4T) | 08 - | | ● |

Street Sport Racing Enduro MX Off Road Racing ATV

RX3

X59

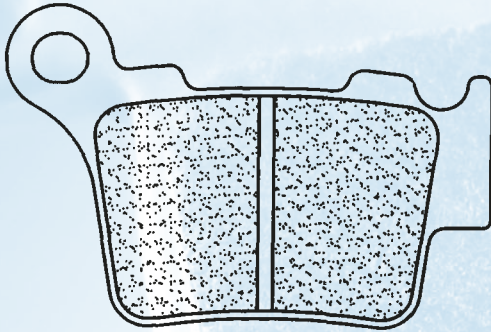

Dim./Size

63,9 mm

42 mm

9,5 mm

1108

BMW

| | | | | |
|---|-----|--------|------|---|
| G | 450 | SMR | 09 - | ● |
| G | 450 | Enduro | 08 - | ● |

HUSABERG

| | | | | |
|----|-----|--------|---------|---|
| FE | 450 | | 09 - | ● |
| FE | 570 | | 09 - | ● |
| SM | 450 | R / RR | 06 - 08 | ● |
| SM | 450 | R | 09 - | ● |

HUSABERG

| | | | | |
|-----|-----|--------|---------|---|
| SM | 510 | R | 06 | ● |
| SM | 570 | R | 06 | ● |
| SM | 610 | | 06 | ● |
| SM | 630 | | 10 - | ● |
| SMR | 630 | | 06 - | ● |
| STR | 650 | CRC | 07 - | ● |
| SM | 450 | R / RR | 06 - 08 | ● |
| SM | 450 | R / RR | 09 - | ● |
| SM | 510 | R | 06 | ● |
| SM | 570 | R | 06 | ● |
| SM | 630 | | 10 - | ● |
| SMR | 630 | | 06 | ● |
| CR | 125 | | 05 - | ● |
| CR | 250 | | 05 - | ● |
| TC | 250 | | 04 - | ● |
| TC | 450 | | 04 - | ● |
| TC | 510 | | 04 - | ● |
| TE | 510 | | 06 - | ● |
| TE | 630 | | 10 - | ● |

KTM

| | | | | |
|-------|-----|-------------------------|---------|---|
| SX | 450 | SM / SM Factory Replica | 04 - | ● |
| SX | 450 | SMR | 04 - 06 | ● |
| SX | 450 | SMR | 07 - 10 | ● |
| SX | 525 | SMR | 04 - 05 | ● |
| SX | 560 | SMR | 06 | ● |
| EXC | 125 | Enduro | 04 - | ● |
| SX | 125 | | 04 - | ● |
| SX | 144 | | 07 - 08 | ● |
| SX | 150 | | 09 - | ● |
| EXC | 200 | Enduro | 04 - | ● |
| SX | 200 | | 03 - 04 | ● |
| EXC | 250 | Enduro / Enduro 4T | 04 - | ● |
| EXC-F | 250 | Enduro 4T | 06 - 10 | ● |
| SX | 250 | | 03 - | ● |
| SX-F | 250 | | 06 - | ● |
| EXC | 300 | Enduro | 04 - | ● |
| EXC | 400 | Racing | 04 - | ● |
| EXC | 450 | Racing | 04 - | ● |
| SX | 450 | | 03 - | ● |
| XC-F | 450 | | 08 - | ● |
| SX-F | 505 | | 07 - 08 | ● |
| XC-F | 505 | | 09 - | ● |
| EXC | 525 | Racing | 04 - | ● |
| SX | 525 | Racing | 04 - 06 | ● |
| EXC | 530 | Racing | 08 | ● |

RIEJU

| | | | | |
|--|-----|----------|---------|---|
| | 250 | Marathon | 09 - 10 | ● |
| | 450 | Marathon | 09 - 10 | ● |

Street Sport Racing Enduro MX Off Road Racing ATV

A3+

XBK5

C59

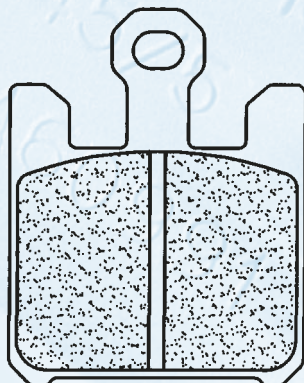

Dim./Size

38,6 mm

49,5 mm

9 mm

1110

DERBI

| | | | | | |
|--|-----|----------|----|---|---|
| | 659 | Mulhacén | 05 | 1 | ● |
|--|-----|----------|----|---|---|

KAWASAKI

| | | | | | |
|--------|------|-----------------|---------|---|---|
| ZX6-RR | 600 | Ninja (Rad.Cal) | 03 - 06 | 2 | ● |
| ZX6-R | 636 | Ninja (Rad.Cal) | 03 - 06 | 2 | ● |
| ZX10-R | 1000 | Ninja (Rad.Cal) | 04 - 07 | 2 | ● |
| ZX12-R | 1200 | Ninja (Rad.Cal) | 04 - | 2 | ● |
| VN | 1600 | Mean Streak | 05 - | 2 | ● |

SUZUKI

| | | | | | |
|-------|------|--------------|------|---|---|
| GSX-R | 1000 | K3 (Rad.cal) | 03 | 2 | ● |
| M | 1600 | Intruder | 05 - | 2 | ● |
| M95 | 1600 | Boulevard | 05 - | 2 | ● |

Street Sport Racing Enduro MX Off Road Racing ATV

ATV1

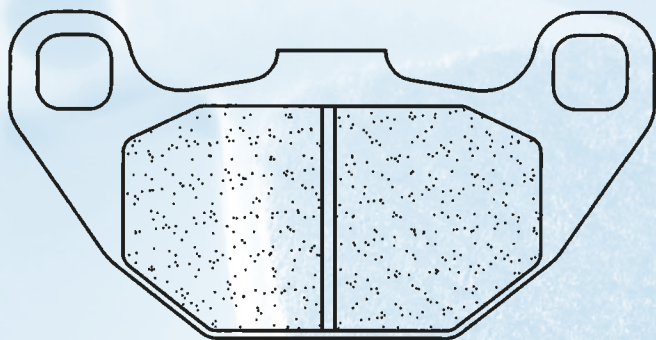

KYMCO

| | | | |
|-----|--------|---------|---|
| 50 | MXer | 00 - 07 | ● |
| 50 | MXu | 05 - 10 | ● |
| 90 | Maxxer | 05 - 06 | ● |
| 125 | MXer | 02 - 07 | ● |
| 150 | MXer | 02 - 07 | ● |
| 150 | MXu | 05 - 10 | ● |

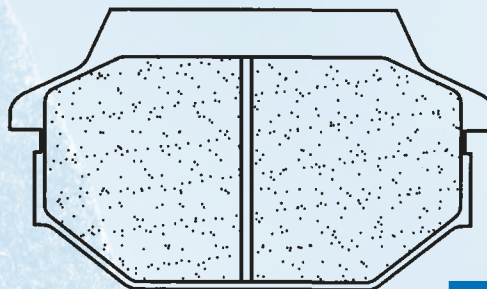

Dim./Size

→ 85 mm
↑ 43 mm
H 8,5 mm

1123

Dim./Size

→ 64 mm
↑ 36,8 mm
H 11 mm

Street Sport Racing Enduro MX Off Road Racing ATV

MX10 X59

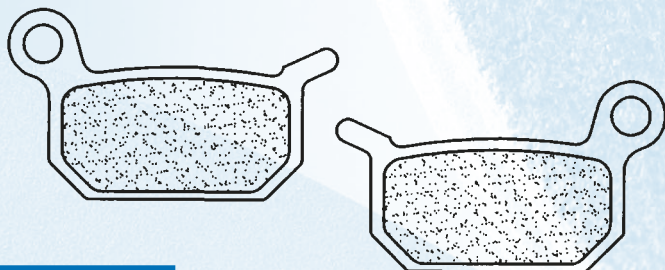

HUSQVARNA

| | | | | |
|----|----|------------|------|---|
| CR | 50 | Pro Senior | 06 - | ● |
| CR | 50 | Senior | 06 - | ● |

KTM

| | | | | | |
|----|----|------------------|---------|---|---|
| SX | 50 | Pro Junior LC | 02 - | 1 | ● |
| SX | 50 | Pro Senior LC | 02 - 03 | 1 | ● |
| SX | 50 | Pro Senior LC | 04 - | 1 | ● |
| SX | 50 | Senior Adventure | 04 - | 1 | ● |
| SM | 50 | | 06 - | 1 | ● |
| SX | 65 | | 04 - 08 | | ● |

LEM

| | | | | | |
|----|----|-----------------|------|---|---|
| | 50 | R2 / R3 / R3 XC | 03 - | 1 | ● |
| RX | 65 | | 05 - | 1 | ● |

POLINI

| | | | | | |
|----|----|----|------|---|---|
| X1 | 50 | R | 04 - | 1 | ● |
| X3 | 50 | R | 04 - | 1 | ● |
| X5 | 65 | RP | 05 - | 1 | ● |

Dim./Size

→ 43,3 mm
↑ 25 mm
H 5 mm

1128

Street Sport Racing Enduro MX Off Road Racing ATV

XBK5

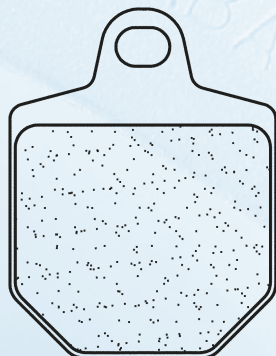

HM

| | | | | | |
|-----|-----|-----------------|---------|---|---|
| CRM | 125 | X Supermotard | 07 | 1 | ● |
| CRM | 250 | X Supermotard | 07 - | 1 | ● |
| CRM | 450 | F Supermotard R | 07 - 08 | 1 | ● |
| CRM | 450 | F Supermotard X | 07 | 1 | ● |
| CRM | 490 | F Supermotard X | 07 | 1 | ● |

KTM

| | | | | | |
|----|-----|-----|---------|---|---|
| SX | 450 | SMR | 07 - 10 | 1 | ● |
| SX | 560 | SMR | 06 | 1 | ● |

Dim./Size

→ 34,9 mm
↑ 45,9 mm
H 17 mm

1129

Street Sport Racing Enduro MX Off Road Racing ATV

A3+ XBK5 C59

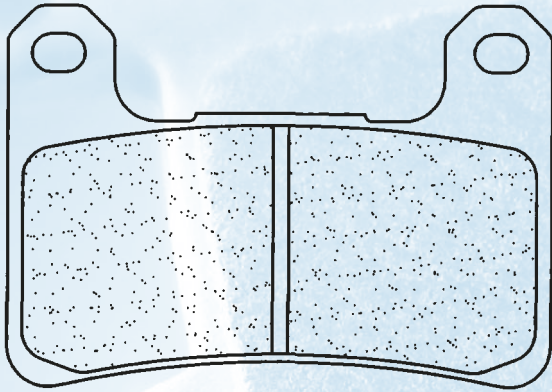

KAWASAKI

| | | | | | |
|---------------|------|------------------------|---------|---|---|
| Z | 1000 | (Rad.Cal) | 10 - | 2 | ● |
| Z | 1000 | SX (Rad.Cal) | 11 - | 2 | ● |
| ZX10-R | 1000 | Ninja (Rad.Cal) | 08 - 10 | 2 | ● |
| ZX10-R | 1000 | Ninja (Rad.Cal) | 11 - | 2 | ● |
| SUZUKI | | | | | |
| GSX-R | 600 | K4 / K5 (Rad.cal) | 04 - 05 | 2 | ● |
| GSX-R | 600 | K6 / K7 (Rad.cal) | 06 - 07 | 2 | ● |
| GSX-R | 600 | K8 / K9 / L0 (Rad.cal) | 08 - 10 | 2 | ● |
| GSX-R | 750 | K4 / K5 (Rad.cal) | 04 - 05 | 2 | ● |
| GSX-R | 750 | K6 / K7 (Rad.cal) | 06 - 07 | 2 | ● |
| GSX-R | 750 | K8 / K9 / L0 (Rad.cal) | 08 - 10 | 2 | ● |
| GSX-R | 1000 | K4 (Rad.cal) | 04 | 2 | ● |
| GSX-R | 1000 | K5 / K6 (Rad.cal) | 05 - 06 | 2 | ● |
| GSX-R | 1000 | K7 / K8 (Rad.cal) | 07 - 08 | 2 | ● |
| GSX-R | 1000 | K9 / L0 (Rad.cal) | 09 - | 2 | ● |
| GSX-R | 1300 | Hayabusa | 08 - | 2 | ● |
| M | 1800 | R Intruder | 06 - 09 | 2 | ● |
| M | 1800 | R2 Intruder | 08 - 09 | 2 | ● |
| M | 1800 | RZ | 07 - 10 | 2 | ● |

Dim./Size

→ **71,4 mm**
↑ **50 mm**
H **7,9 mm**

1133

Street Sport Racing Enduro MX Off Road Racing ATV

A3+ XBK5 C59

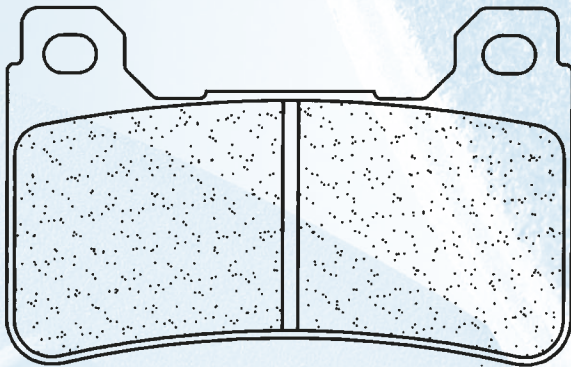

HONDA

| | | | | | |
|-----|------|------------------------|---------|---|---|
| CBR | 600 | RR (Rad.cal) | 05 - 06 | 2 | ● |
| CBR | 600 | RR (Rad.cal) | 07 - | 2 | ● |
| CBR | 600 | RR (Rad.cal) - ABS | 09 - | 2 | ● |
| CB | 1000 | R (Rad.cal) | 08 - | 2 | ● |
| CBR | 1000 | RR Fireblade (Rad.cal) | 04 - 05 | 2 | ● |
| CBR | 1000 | RR Fireblade (Rad.cal) | 06 - 08 | 2 | ● |
| CBR | 1000 | RR Fireblade (Rad.cal) | 09 - | 2 | ● |

Dim./Size

→ **74,4 mm**
↑ **47 mm**
H **7,9 mm**

1134

Street Sport Racing Enduro MX Off Road Racing ATV

A3+

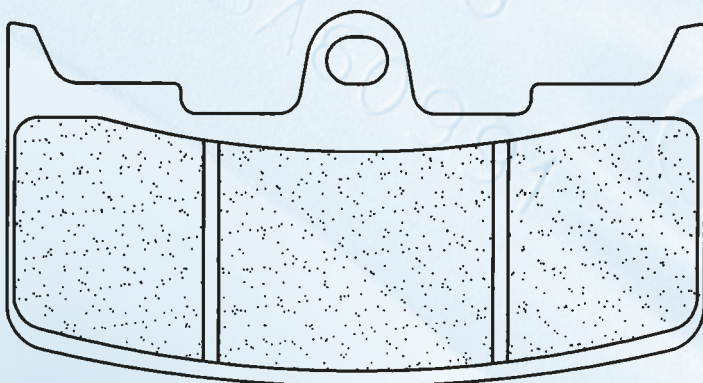

BUELL

| | | | | | |
|--------------|------|------------------|---------|---|---|
| XB-9R | 984 | Firebolt | 02 - | 1 | ● |
| XB-9S | 984 | Lightning | 03 - | 1 | ● |
| XB-9SX | 984 | Lightning City X | 04 - | 1 | ● |
| XB-12R | 1200 | Firebolt | 04 - 08 | 1 | ● |
| XB-12S | 1200 | Lightning | 04 - 08 | 1 | ● |
| XB-12Scg1200 | 1200 | Lightning | 06 - 08 | 1 | ● |
| XB-12Ss | 1200 | Lightning Long | 06 - 08 | 1 | ● |
| XB-12STT1200 | 1200 | Supet TT | 07 - | 1 | ● |
| XB-12X | 1200 | Ulysses | 06 - | 1 | ● |

Dim./Size

→ **91,8 mm**
↑ **49,5 mm**
H **8 mm**

1139

Street Sport Racing Enduro MX Off Road Racing ATV

X59 ATV1

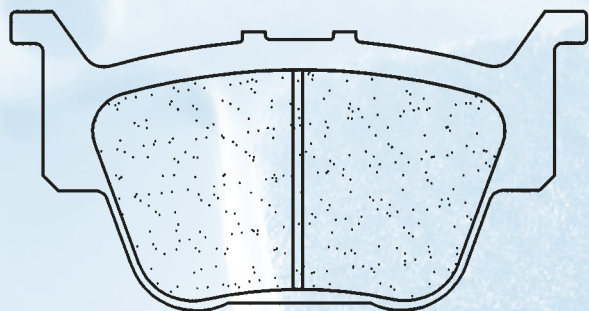

HONDA

| | | | | |
|-----|-----|-------------|---------|---|
| TRX | 420 | FA / FPA | 09 - | ● |
| TRX | 450 | R | 04 - | ● |
| TRX | 650 | FA Rincon | 03 - 05 | ● |
| TRX | 650 | FGA Rincon | 04 - 05 | ● |
| TRX | 680 | FA6 Rincon | 06 - | ● |
| TRX | 680 | FGA6 Rincon | 06 - | ● |

Dim./Size
— 75,3 mm
↑ 39,5 mm
H 9,7 mm

1140

Street Sport Racing Enduro MX Off Road Racing ATV

ATV1

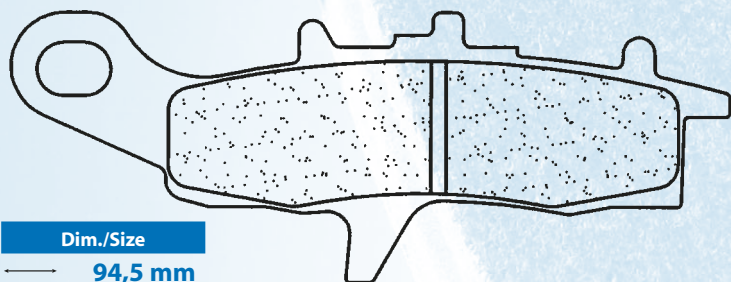

Dim./Size
— 94,5 mm
↑ 35,5 mm
H 7,4 mm

KAWASAKI

| | | | | | | |
|-----|-----|---------------------|---------|---|---|---|
| KFX | 450 | | 07 - | R | 1 | ● |
| KVF | 650 | Brute Force 4X4 D/E | 05 - | R | 1 | ● |
| KVF | 650 | Prairie | 01 - 03 | R | 1 | ● |
| KFX | 700 | V-Force | 04 - | R | 1 | ● |
| KSV | 700 | V-Force A1 | 04 - | R | 1 | ● |
| KVF | 700 | Prairie | 04 - | R | 1 | ● |

SUZUKI

| | | | | | | |
|------|-----|-----------------------|---------|---|---|---|
| LT-V | 700 | Quadrunner Twin Peaks | 04 - 05 | R | 1 | ● |
|------|-----|-----------------------|---------|---|---|---|

Dim./Size
— 119,5 mm
↑ 26,5 mm
H 7,1 mm

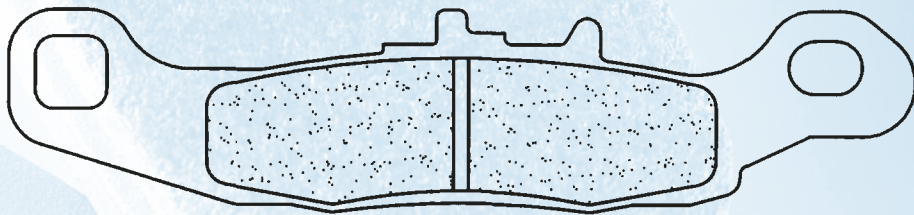

1141

Street Sport Racing Enduro MX Off Road Racing ATV

ATV1

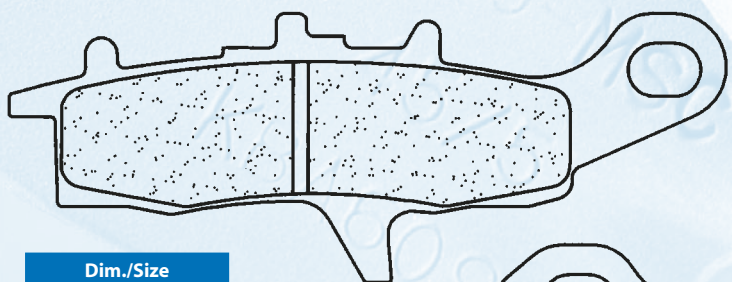

Dim./Size
— 94,5 mm
↑ 35,5 mm
H 7,4 mm

KAWASAKI

| | | | | | | |
|-----|-----|---------------------|---------|---|---|---|
| KFX | 450 | | 07 - | L | 1 | ● |
| KVF | 650 | Brute Force 4X4 D/E | 05 - | L | 1 | ● |
| KVF | 650 | Prairie | 01 - 03 | L | 1 | ● |
| KFX | 700 | V-Force | 04 - | L | 1 | ● |
| KSV | 700 | V-Force A1 | 04 - | L | 1 | ● |
| KVF | 700 | Prairie | 04 - | L | 1 | ● |

SUZUKI

| | | | | | | |
|------|-----|-----------------------|---------|---|---|---|
| LT-V | 700 | Quadrunner Twin Peaks | 04 - 05 | L | 1 | ● |
|------|-----|-----------------------|---------|---|---|---|

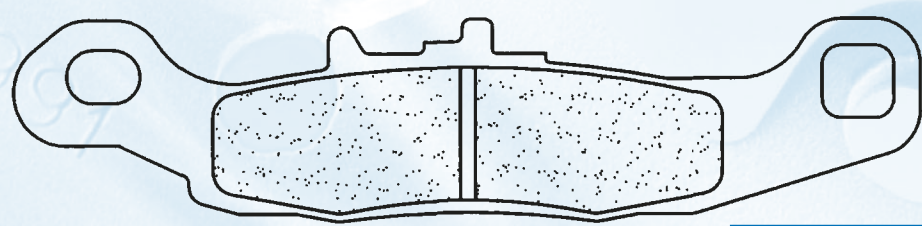

Dim./Size
— 119,5 mm
↑ 26,5 mm
H 7,1 mm

1142

Street Sport Racing Enduro MX Off Road Racing ATV

S4

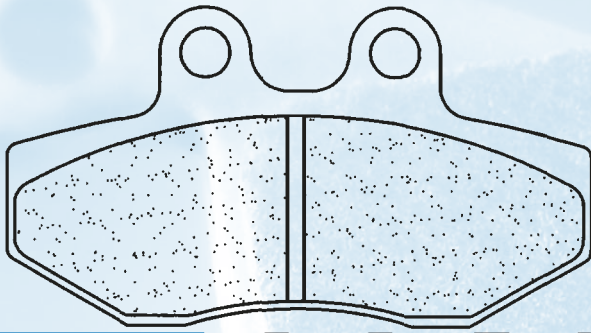

Dim./Size

→ 77 mm
↑↓ 42 mm
H 7,5 mm

1144

APRILIA

| | | | | |
|-----|--------------|---------|---|---|
| 125 | Classic | 96 - | 1 | ● |
| 125 | Pegaso | 90 - 91 | 1 | ● |
| 125 | Red Rose | 90 - | 1 | ● |
| 125 | Tuareg Rally | 92 | 1 | ● |
| 125 | Tuareg Wind | 90 - | 1 | ● |

HRD

| | | | | |
|-----|-------------|---------|---|---|
| 125 | Supermotard | 00 - 02 | 1 | ● |
| 125 | Trail | 00 - 02 | 1 | ● |

RIEJU

| | | | | |
|-----|-----|---------|---|---|
| 125 | MRX | 02 - 08 | 1 | ● |
| 125 | SMX | 02 - 07 | 1 | ● |

SACHS

| | | | | |
|-----|----------|---------|---|---|
| 125 | Roadster | 00 - 03 | 1 | ● |
|-----|----------|---------|---|---|

SHERCO

| | | | | |
|-----|------------------------|---------|---|---|
| 125 | City Corp (All models) | 03 - 07 | 1 | ● |
|-----|------------------------|---------|---|---|

SIMSON

| | | | | |
|-----|----|------|---|---|
| 125 | SM | 01 - | 1 | ● |
|-----|----|------|---|---|

Street Sport Racing Enduro MX Off Road Racing ATV

RX3

1145

Dim./Size

→ 69,7 mm
↑↓ 46,3 mm
H 13 mm

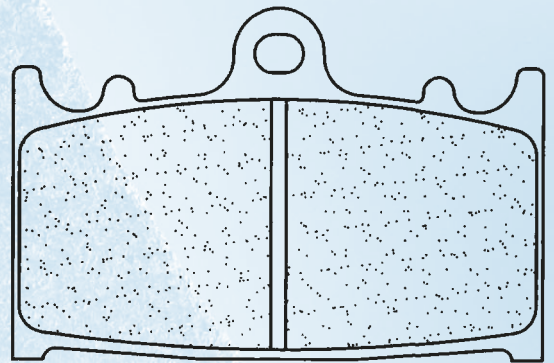

SUZUKI

| | | | | |
|-----|------|----------------------------|---------|---|
| VL | 1500 | Intruder Legendary Classic | 02 - 03 | ● |
| C | 1500 | Intruder | 05 - 09 | ● |
| C90 | 1500 | Boulevard | 05 - 09 | ● |

Street Sport Racing Enduro MX Off Road Racing ATV

S4

XBK5

EN10

MX10

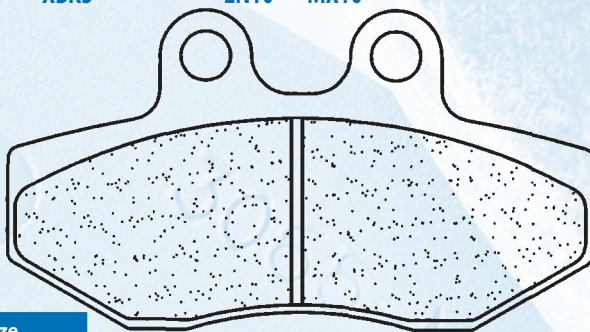

Dim./Size

→ 77 mm
↑↓ 42 mm
H 7,5 mm

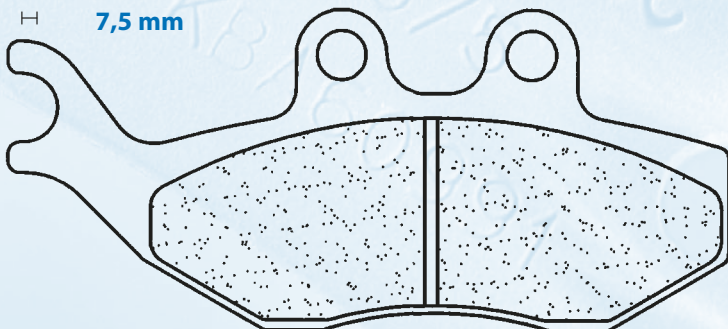

1146

Dim./Size

→ 94,7 mm
↑↓ 42 mm
H 7,5 mm

AJP

| | | | | | |
|-----|-----|-------------|------|---|---|
| PR3 | 125 | Supermotard | 08 - | 1 | ● |
| PR3 | 200 | Supermotard | 08 - | 1 | ● |
| MX | 200 | | 09 - | 1 | ● |
| PR3 | 125 | Enduro | 08 - | 1 | ● |
| PR3 | 200 | Enduro | 08 - | 1 | ● |

APRILIA

| | | | | | |
|-----|--------|------|---------|---|---|
| 125 | Pegaso | 92 - | 1 | ● | |
| RX | 125 | | 92 - 07 | 1 | ● |

BETA

| | | | | | |
|-----|-------|-------------|---------|---|---|
| 125 | M4 | 06 - | 1 | ● | |
| 125 | Urban | 10 - | 1 | ● | |
| RR | 125 | Supermotard | 08 - | 1 | ● |
| 200 | Urban | 10 - | 1 | ● | |
| ALP | 125 | 4 Stroke | 06 - | 1 | ● |
| RR | 125 | Enduro | 06 - | 1 | ● |
| ALP | 200 | 4 Stroke | 06 - | 1 | ● |
| ALP | 350 | 4.0 | 04 - 05 | 1 | ● |
| ALP | 350 | 4.0 | 06 - | 1 | ● |

DERBI

| | | | | |
|-----|---------------------|------|---|---|
| 125 | Mulhacén | 07 | 1 | ● |
| 125 | Senda X-Treme SM 4T | 04 - | 1 | ● |
| 125 | Senda R 4T | 04 - | 1 | ● |

FANTIC

| | | | | |
|-----|----------------------------|------|---|---|
| 125 | Caballero Motard Aircooled | 10 - | 1 | ● |
| 125 | Regolarna Casa | 08 - | 1 | ● |
| 125 | Supersei Motard | 08 - | 1 | ● |

GAS GAS

| | | | | |
|-----|---------|------|---|---|
| 125 | Pampera | 04 - | 1 | ● |
| 250 | Pampera | 03 - | 1 | ● |
| 280 | Pampera | 04 - | 1 | ● |

HM

| | | | | | |
|-----|-----|-------|----|---|---|
| CRE | 125 | F / X | 09 | 1 | ● |
|-----|-----|-------|----|---|---|

KEEWAY

| | | | | |
|-----|--------|------|---|---|
| 125 | Enduro | 07 - | 1 | ● |
| 125 | X-Ray | 07 - | 1 | ● |

SHERCO

| | | | | |
|-----|-------------------------------|------|---|---|
| 125 | City Corp (All models) | 08 - | 1 | ● |
| 125 | SM 1.25i F Black Panther (4T) | 10 - | 1 | ● |
| 125 | SE 1.25 F Enduro (4T) | 10 - | 1 | ● |

YAMAHA

| | | | | | |
|-----|-----|---------------|---------|---|---|
| TZR | 50 | | 03 - 08 | 1 | ● |
| XT | 125 | X Supermotard | 05 - | 1 | ● |

Street Sport Racing Enduro MX Off Road Racing ATV

RX3

X59 **ATV1**

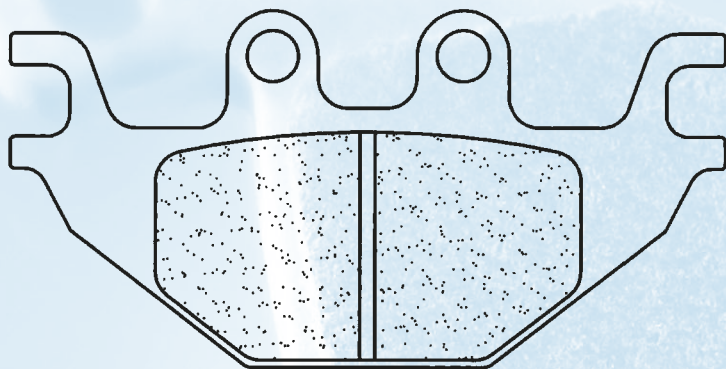

Dim./Size

94 mm

47 mm

8,8 mm

Dim./Size

73,2 mm

47 mm

10,8 mm

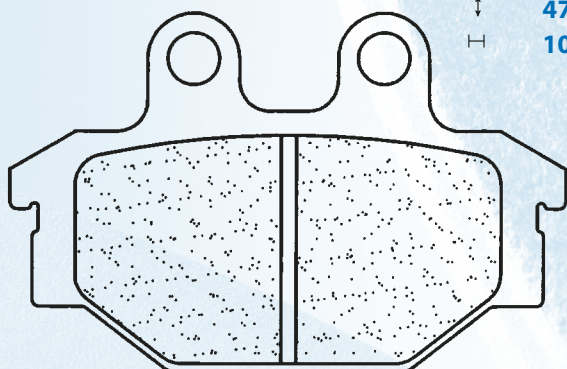

ADLY

| | | | | |
|-----|--------------|------|---|---|
| 300 | Cross X Over | 07 - | 2 | ● |
| 300 | Cross X road | 07 - | 2 | ● |
| 300 | Sport | 07 - | 2 | ● |
| 320 | S | 07 - | 2 | ● |
| 320 | U | 07 - | 2 | ● |

BOMBARDIER

| | | | | | |
|-----|----|------|---|---|---|
| 250 | DS | 06 - | 2 | ● | ● |
|-----|----|------|---|---|---|

CAN-AM

| | | | | | |
|-----|----|------|---|---|---|
| 250 | DS | 07 - | 2 | ● | ● |
|-----|----|------|---|---|---|

CPI

| | | | | |
|-----|----|------|---|---|
| 250 | XS | 07 - | 2 | ● |
|-----|----|------|---|---|

HERCULES

| | | | | |
|-----|-----|------|---|---|
| 280 | ATV | 07 - | 2 | ● |
|-----|-----|------|---|---|

| | | | | |
|-----|-----|------|---|---|
| 300 | ATV | 07 - | 2 | ● |
|-----|-----|------|---|---|

KYMCO

| | | | | |
|-----|-----|---------|---|---|
| 250 | KXR | 04 - 07 | 2 | ● |
|-----|-----|---------|---|---|

| | | | | |
|-----|-----|---------|---|---|
| 250 | MXu | 04 - 09 | 2 | ● |
|-----|-----|---------|---|---|

| | | | | |
|-----|------------|------|---|---|
| 250 | Urban Quad | 06 - | 2 | ● |
|-----|------------|------|---|---|

| | | | | |
|-----|--------|---------|---|---|
| 300 | Maxxer | 06 - 10 | 2 | ● |
|-----|--------|---------|---|---|

| | | | | | |
|-----|-----|------|---|---|---|
| 300 | MXu | 06 - | 2 | ● | ● |
|-----|-----|------|---|---|---|

| | | | | | |
|-----|-----|---------|---|---|---|
| 500 | MXu | 05 - 09 | 2 | ● | ● |
|-----|-----|---------|---|---|---|

| | | | | | |
|-----|---------|------|---|---|---|
| 500 | UXV 4x4 | 08 - | 2 | ● | ● |
|-----|---------|------|---|---|---|

SYM

| | | | | |
|-----|-------------|---------|---|---|
| 200 | Trackrunner | 05 - 09 | 2 | ● |
|-----|-------------|---------|---|---|

| | | | | |
|-----|------------|---------|---|---|
| 250 | Quadlander | 05 - 09 | 2 | ● |
|-----|------------|---------|---|---|

| | | | | |
|-----|---------|------|---|---|
| 300 | Citymax | 06 - | 2 | ● |
|-----|---------|------|---|---|

| | | | | | |
|-----|---------------|------|---|---|---|
| 300 | Outlander / S | 07 - | 2 | ● | ● |
|-----|---------------|------|---|---|---|

| | | | | | |
|-----|------------|------|---|---|---|
| 300 | Quadlander | 06 - | 2 | ● | ● |
|-----|------------|------|---|---|---|

| | | | | | |
|-----|------------|---------|---|---|---|
| 600 | Quadraider | 08 - 09 | 2 | ● | ● |
|-----|------------|---------|---|---|---|

| | | | | | |
|-----|---------------|------|---|---|---|
| 600 | Quadraider LE | 10 - | 2 | ● | ● |
|-----|---------------|------|---|---|---|

| | | | | | |
|-----|------------|---------|--|---|---|
| 600 | Quadraider | 06 - 07 | | ● | ● |
|-----|------------|---------|--|---|---|

TGB

| | | | | | |
|-----|------------------|---------|---|---|---|
| 400 | Avenger 4x2 / LE | 07 - 09 | 2 | ● | ● |
|-----|------------------|---------|---|---|---|

| | | | | | |
|-----|-----------|---------|---|---|---|
| 425 | Blade 4x4 | 07 - 09 | 2 | ● | ● |
|-----|-----------|---------|---|---|---|

| | | | | | |
|-----|--------------|------|---|---|---|
| 425 | Blade 4x4 SE | 09 - | 2 | ● | ● |
|-----|--------------|------|---|---|---|

| | | | | | |
|-----|---------------|---------|---|---|---|
| 500 | Avenger 4x2 R | 07 - 09 | 2 | ● | ● |
|-----|---------------|---------|---|---|---|

| | | | | | |
|-----|--------------|------|---|---|---|
| 525 | Blade 4x4 SE | 09 - | 2 | ● | ● |
|-----|--------------|------|---|---|---|

| | | | | | |
|-----|--------------|------|---|---|---|
| 525 | Blade 4x4 SL | 09 - | 2 | ● | ● |
|-----|--------------|------|---|---|---|

| | | | | | |
|-----|--------|------|---|---|---|
| 525 | SE 4x4 | 09 - | 2 | ● | ● |
|-----|--------|------|---|---|---|

| | | | | | |
|-----|-------------------|------|---|---|---|
| 550 | Blade 4x4 SE / SL | 09 - | 2 | ● | ● |
|-----|-------------------|------|---|---|---|

YAMAHA

| | | | | |
|---------|---|------|--|---|
| YZF 125 | R | 08 - | | ● |
|---------|---|------|--|---|

1147

Street Sport Racing Enduro MX Off Road Racing ATV

A3+

XBK5

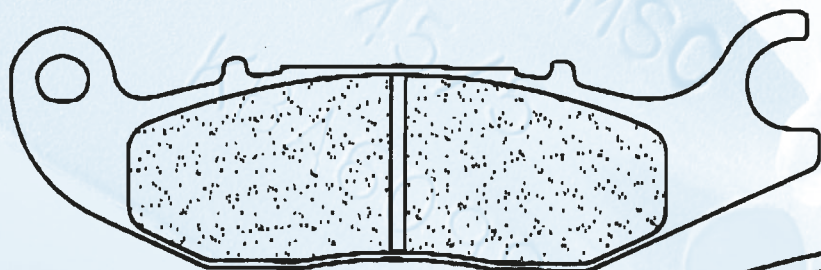

Dim./Size

111 mm

36,2 mm

7,6 mm

Dim./Size

98,6 mm

33 mm

7,6 mm

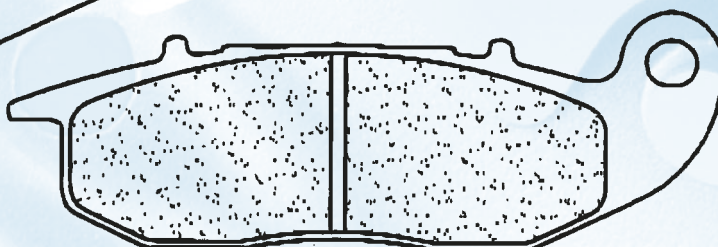

1148

HONDA

| | | | | |
|---------|--|------|---|---|
| CBF 125 | | 09 - | 1 | ● |
|---------|--|------|---|---|

| | | | | |
|---------|---|------|---|---|
| CBR 125 | R | 04 - | 1 | ● |
|---------|---|------|---|---|

| | | | | |
|---------|---|------|---|---|
| CBR 150 | R | 00 - | 1 | ● |
|---------|---|------|---|---|

RIEJU

| | | | | |
|-----|-----|---------|---|---|
| 125 | NKD | 08 - 10 | 1 | ● |
|-----|-----|---------|---|---|

| | | | | |
|-----|----------------------|---------|---|---|
| 125 | RS2 (J.Juan Caliper) | 07 - 10 | 1 | ● |
|-----|----------------------|---------|---|---|

| | | | | |
|-----|--------------------------|---------|---|---|
| 125 | RS2 Pro (J.Juan Caliper) | 07 - 10 | 1 | ● |
|-----|--------------------------|---------|---|---|

Street Sport Racing Enduro MX Off Road Racing ATV

A3+

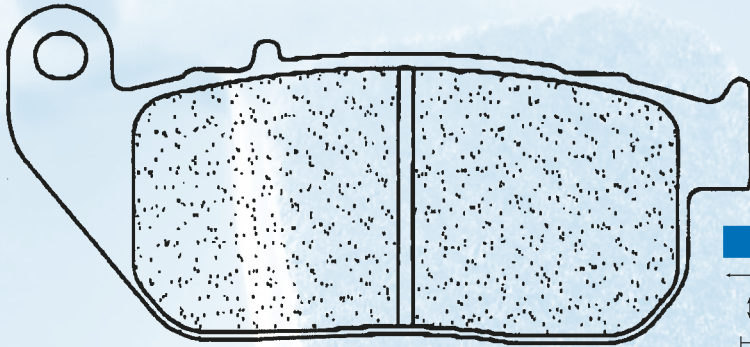

HARLEY DAVIDSON

| | | | | | |
|----|------|----------------------|---------|---|---|
| XL | 883 | Sportster C Custom | 04 - 05 | 1 | ● |
| XL | 883 | Sportster C Custom | 06 - | 1 | ● |
| XL | 883 | Sportster L Low | 04 - 05 | 1 | ● |
| XL | 883 | Sportster L Low | 06 - | 1 | ● |
| XL | 883 | Sportster R Roadster | 04 - 05 | 2 | ● |
| XL | 883 | Sportster R Roadster | 06 - | 2 | ● |
| XL | 883 | Sportster Standard | 04 - 05 | 1 | ● |
| XL | 883 | Sportster Standard | 06 - | 1 | ● |
| XL | 1200 | Sportster C Custom | 04 - | 1 | ● |
| XL | 1200 | Sportster L Low | 06 - | 1 | ● |
| XL | 1200 | N Nightster | 06 - | 1 | ● |
| XL | 1200 | Sportster R Roadster | 04 - | 2 | ● |

Dim./Size

→ **102 mm**
↑↓ **45,9 mm**
H **10 mm**

1149

Street Sport Racing Enduro MX Off Road Racing ATV

RX3

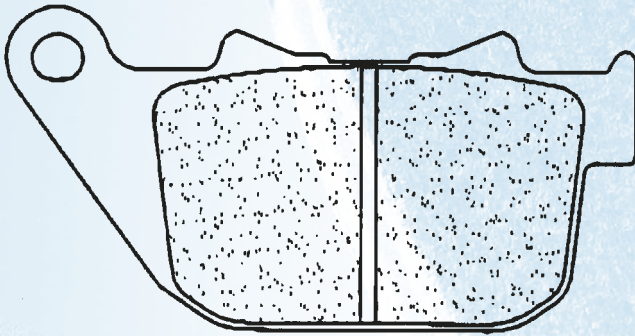

HARLEY DAVIDSON

| | | | | | |
|----|------|----------------------|---------|--|---|
| XL | 883 | Sportster C Custom | 04 - 05 | | ● |
| XL | 883 | Sportster C Custom | 06 - | | ● |
| XL | 883 | Sportster L Low | 04 - 05 | | ● |
| XL | 883 | Sportster L Low | 06 - | | ● |
| XL | 883 | Sportster R Roadster | 04 - 05 | | ● |
| XL | 883 | Sportster R Roadster | 06 - | | ● |
| XL | 883 | Sportster Standard | 04 - 05 | | ● |
| XL | 883 | Sportster Standard | 06 - | | ● |
| XL | 1200 | Sportster C Custom | 04 - | | ● |
| XL | 1200 | Sportster L Low | 06 - | | ● |
| XL | 1200 | N Nightster | 06 - | | ● |
| XL | 1200 | Sportster R Roadster | 04 - | | ● |
| XR | 1200 | | 08 - | | ● |

Dim./Size

→ **86 mm**
↑↓ **44,5 mm**
H **10,4 mm**

1150

Street Sport Racing Enduro MX Off Road Racing ATV

1151

X59 ATV1

Dim./Size

→ **45 mm**
↑↓ **50,8 mm**
H **7 mm**

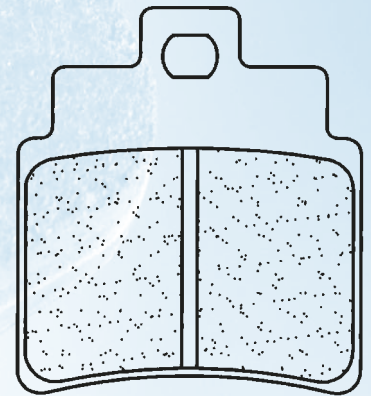

GILERA

| | | | |
|-----|-------------|------|---|
| 250 | Oregon Quad | 07 - | ● |
|-----|-------------|------|---|

KYMCO

| | | | |
|-----|------------|---------|---|
| 250 | KXR | 04 - 07 | ● |
| 250 | MXu | 04 - 09 | ● |
| 250 | Urban Quad | 06 - | ● |
| 300 | Maxxer | 06 - 10 | ● |

Street Sport Racing Enduro MX Off Road Racing ATV

X59

SUZUKI

| | | | | |
|----|----|----|---------|---|
| RM | 85 | /L | 05 - 10 | ● |
|----|----|----|---------|---|

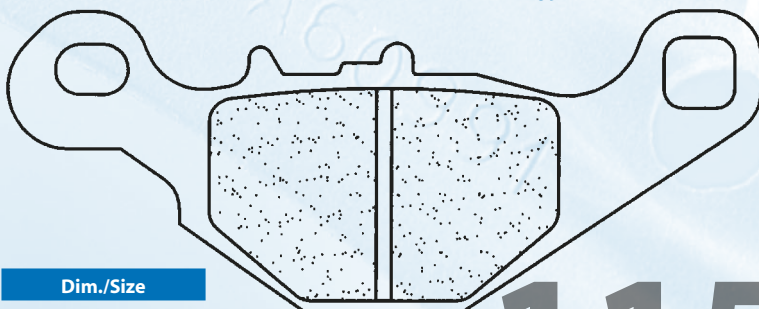

Dim./Size

→ **99,2 mm**
↑↓ **39,7 mm**
H **7,6 mm**

1152



Dim./Size

→ **75,7 mm**
↑↓ **40,6 mm**
H **8,4 mm**

Street Sport Racing Enduro MX Off Road Racing ATV

XBK5 C59



| HONDA | | | | | |
|-------|-----|---|------|---|---|
| RS | 125 | R | 95 - | 1 | ● |
| RS | 250 | R | 93 - | 2 | ● |

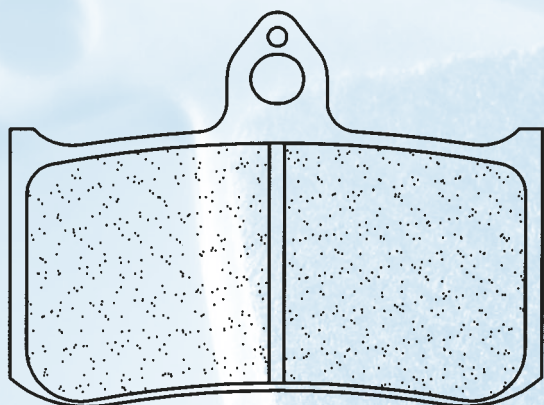

1157

Dim./Size

→ **69,6 mm**
↑ **52 mm**
H **8 mm**

Street Sport Racing Enduro MX Off Road Racing ATV

A3+ RX3 XBK5



| HONDA | | | | | |
|--------|------|--------------------------|------|---|---|
| CBF | 500 | ABS | 04 - | 1 | ● |
| CB | 600 | Hornet ABS | 07 - | 2 | ● |
| CBF | 600 | N / S - ABS | 08 - | 2 | ● |
| DN-01 | 680 | | 08 - | 2 | ● |
| NT | 700 | Deauville / ABS | 06 - | 2 | ● |
| XL | 700 | Transalp | 08 - | 2 | ● |
| VFR | 800 | VTEC / VTEC ABS | 06 - | 2 | ● |
| CB | 1000 | R (Rad.cal) ABS | 08 - | 2 | ● |
| CBF | 1000 | ABS | 06 - | 2 | ● |
| CBF | 1000 | Limited Edition ABS | 09 - | 2 | ● |
| XL | 1000 | Varadero | 07 - | 2 | ● |
| XL | 1000 | Varadero ABS | 04 - | 2 | ● |
| XL | 1000 | Varadero Travel ABS | 05 - | 2 | ● |
| SUZUKI | | | | | |
| C | 1800 | R Intruder / RT Intruder | 08 - | 2 | ● |

1159

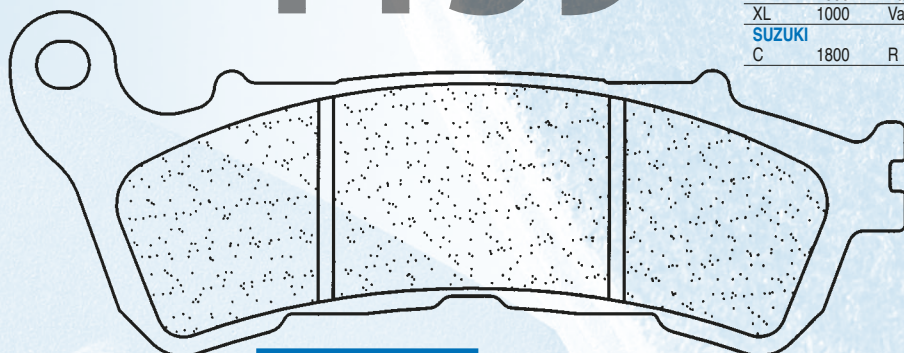

Dim./Size

→ **117,9 mm**
↑ **45,4 mm**
H **9 mm**

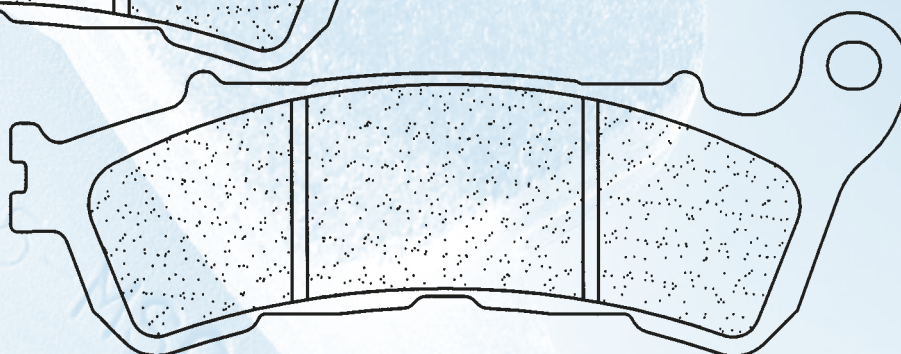

Street Sport Racing Enduro MX Off Road Racing ATV

RX3



| SUZUKI | | | | | |
|--------|------|------------------------|---------|--|---|
| GSR | 400 | K6 | 06 - | | ● |
| GSR | 600 | K6 / K7 / K8 | 06 - | | ● |
| GSX-R | 600 | K6 / K7 (Rad.cal) | 06 - 07 | | ● |
| GSX-R | 600 | K8 / K9 / L0 (Rad.cal) | 08 - 10 | | ● |
| GSX-R | 750 | K6 / K7 (Rad.cal) | 06 - 07 | | ● |
| GSX-R | 750 | K8 / K9 / L0 (Rad.cal) | 08 - 10 | | ● |
| GSX-R | 1000 | K7 / K8 (Rad.cal) | 07 - 08 | | ● |
| GSX-R | 1300 | Hayabusa | 08 - | | ● |
| GSX | 1340 | B-king | 08 - | | ● |

Dim./Size

→ **89,2 mm**
↑ **40,6 mm**
H **9,8 mm**

1163

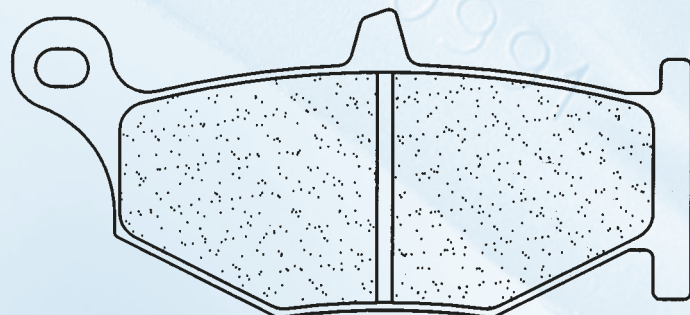

Street Sport Racing Enduro MX Off Road Racing ATV

X59 ATV1

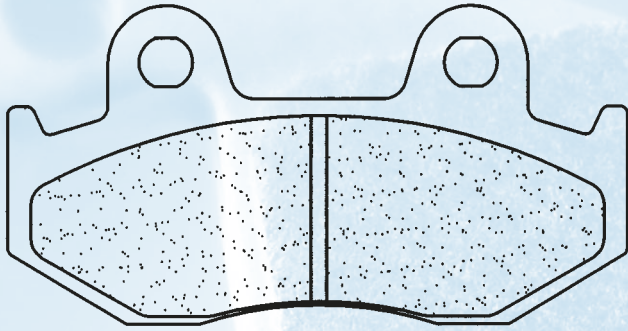

HONDA

| | | | | | | |
|-----|-----|------------|---------|---|---|---|
| ATC | 250 | R | 85 - 86 | 1 | ● | ● |
| ATC | 250 | X | 85 | 1 | ● | ● |
| ATC | 300 | X | 85 | 1 | ● | ● |
| TRX | 250 | R Fourtrax | 86 - 89 | | ● | ● |
| TRX | 250 | X Fourtrax | 87 | | ● | ● |

YAMAHA

| | | | | | | |
|-----|-----|-----------|---------|---|---|---|
| YFZ | 450 | V / W / X | 06 - 08 | L | ● | ● |
| YFZ | 450 | RY / RZ | 09 - | L | ● | ● |

Dim./Size

→ 81,1 mm
↑ ↓ 42 mm
H 9,2 mm

1164

Street Sport Racing Enduro MX Off Road Racing ATV

X59 ATV1

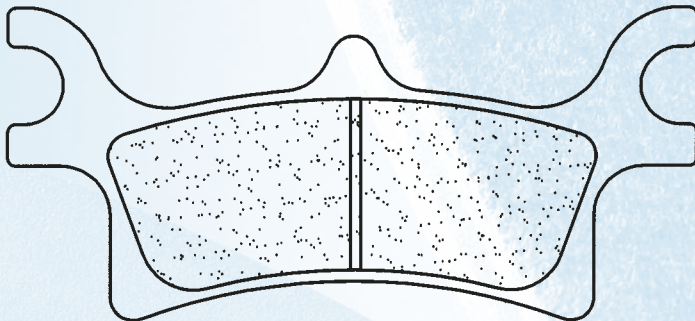

POLARIS

| | | | | |
|-----|-----------------------|---------|---|---|
| 325 | Xpedition | 02 - | ● | ● |
| 330 | ATP | 06 - | ● | ● |
| 330 | E Trail Blazer | 08 - | ● | ● |
| 330 | Magnum 2X4 / 4X4 | 03 - 06 | ● | ● |
| 450 | Sportsman | 06 - | ● | ● |
| 500 | Magnum 2X4 / 4x4 HDS | 02 - 03 | ● | ● |
| 500 | Predator E | 06 - | ● | ● |
| 500 | Ranger 6x6 | 00 - 02 | ● | ● |
| 500 | Scrambler 2x4 | 07 - 08 | ● | ● |
| 500 | E Scrambler 2x4 / 4x4 | 08 - | ● | ● |
| 500 | Scrambler 4x4 | 05 - 10 | ● | ● |
| 500 | Sportsman 6x6 | 00 - 08 | ● | ● |
| 500 | Sportsman Efi / HO | 03 - 08 | ● | ● |
| 500 | Sportsman Efi Quad | 08 - 10 | ● | ● |
| 500 | Sportsman X2 | 06 - 08 | ● | ● |
| 600 | Sportsman 4x4 | 03 - 05 | ● | ● |
| 700 | Sportsman 4x4 | 02 - 06 | ● | ● |
| 700 | Sportsman MV 700 | 05 - 06 | ● | ● |
| 700 | Sportsman Efi | 07 - | ● | ● |
| 800 | Sportsman Efi | 05 - 07 | ● | ● |
| 800 | Sportsman Efi Int/HO | 07 - 10 | ● | ● |

Dim./Size

→ 90,3 mm
↑ ↓ 41,2 mm
H 8,2 mm

1165

Street Sport Racing Enduro MX Off Road Racing ATV

RX3

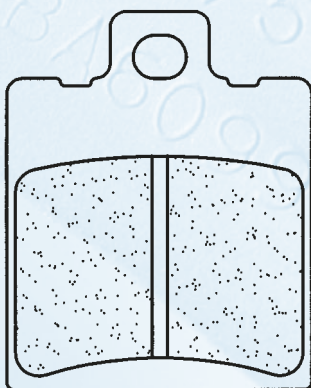
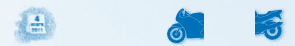

APRILIA

| | | | | | |
|----|-----|---------------------|---------|---|---|
| RS | 125 | / Extrema / Replica | 93 - 98 | ● | ● |
| RS | 125 | | 99 - 05 | ● | ● |
| RS | 125 | R Piste | 04 - 05 | ● | ● |

BENELLI

| | | | | | |
|-----|-----|--------------|------|---|---|
| 666 | 125 | Born in hell | 98 - | ● | ● |
|-----|-----|--------------|------|---|---|

Dim./Size

→ 39,7 mm
↑ ↓ 50 mm
H 7 mm

1167

Street Sport Racing Enduro MX Off Road Racing ATV

X59 ATV1

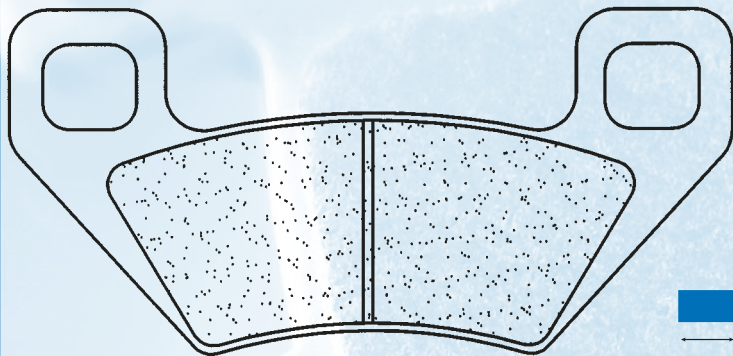

Dim./Size
 — 94,5 mm
 ↑ 45,5 mm
 H 7 mm

1171

| ARCTIC CAT | | | |
|-------------------|-----------------|--------|-----|
| 250 | 2X4 | 05 - 2 | ● ● |
| 300 | 4x4 | 05 - 2 | ● ● |
| 400 | 2x4 / 4x4 (FIS) | 05 - 2 | ● ● |
| 500 | 2x4 / 4x4 (FIS) | 05 - 2 | ● ● |
| 500 | TBX 4x4 | 05 - 2 | ● ● |
| 500 | TRV 4x4 | 05 - 2 | ● ● |
| 550 | TRV | 09 - 2 | ● ● |
| 650 | H1 4x4 Aut. | 05 - 2 | ● ● |
| 650 | V2 4x4 Aut LE | 05 - 2 | ● ● |
| 650 | V2 4x4 Aut. | 05 - 2 | ● ● |
| 700 | TRV | 09 - 2 | ● ● |
| 1000 | TRV Thunder Cat | 09 - 2 | ● ● |
| 1000 | TRV | 09 - 2 | ● ● |
| KYMCO | | | |
| 400 | MXu | 08 - 2 | ● ● |
| POLARIS | | | |
| 300 | Hawkeye | 06 - 2 | ● ● |

Street Sport Racing Enduro MX Off Road Racing ATV

A3+ RX3

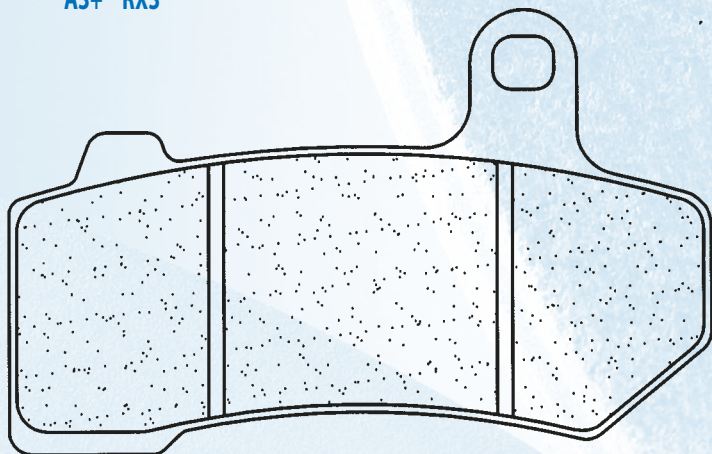

Dim./Size
 — 91,9 mm
 ↑ 58,5 mm
 H 7 mm

1172

| HARLEY DAVIDSON | | | |
|------------------------|-----------------------------|--------|-----|
| VRSCF 1130 | Muscle | 09 - 1 | ● ● |
| VRSCA 1130 | V-Rod | 06 - 2 | ● ● |
| VRSCAW1130 | V-Rod | 08 - 2 | ● ● |
| VRSCD 1130 | Night Rod | 06 - 2 | ● ● |
| VRSCX 1130 | V-rod | 08 - 2 | ● ● |
| VRSCDX 1130 | Night Rod Special | 06 - 2 | ● ● |
| VRSCR 1130 | Street Rod | 06 - 2 | ● ● |
| FLHR 1584 | Road King | 08 - 2 | ● ● |
| FLHRC 1584 | Road king Classic | 08 - 2 | ● ● |
| FLHT 1584 | Electra Glide Standard | 08 - 2 | ● ● |
| FLHTC 1584 | Electra Glide Classic | 08 - 2 | ● ● |
| FLHTCI 1584 | Ultra Electra Glide Classic | 08 - 2 | ● ● |
| FLHX 1584 | Street Glide | 08 - 2 | ● ● |
| FLTR 1584 | Road Glide | 08 - 2 | ● ● |

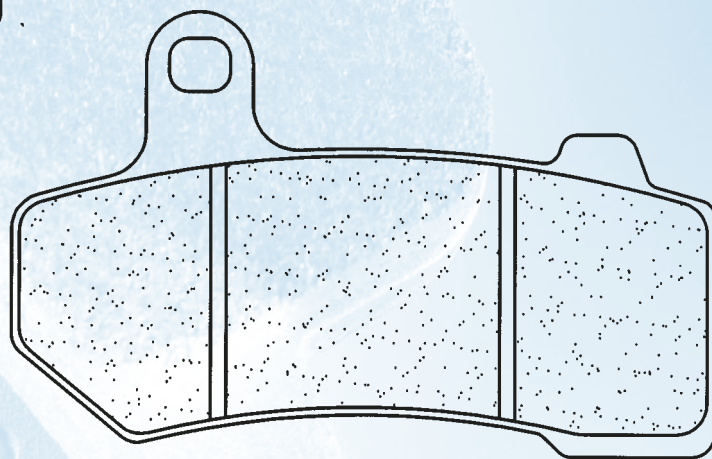

Street Sport Racing Enduro MX Off Road Racing ATV

RX3

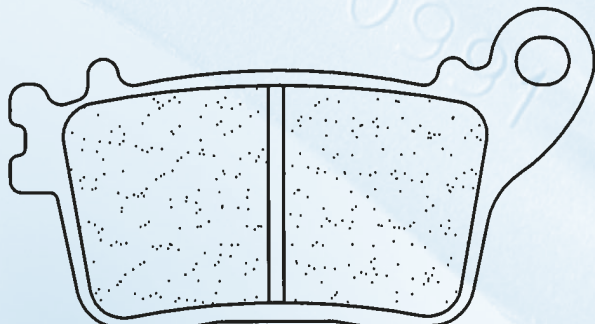

Dim./Size
 — 77,5 mm
 ↑ 42,3 mm
 H 10,4 mm

1174

| HONDA | | | |
|---------------|------------------------|---------|---|
| CB 600 | Hornet | 07 - | ● |
| CBR 600 | RR (Rad.cal) | 07 - | ● |
| CBR 600 | RR (Rad.cal) - ABS | 09 - | ● |
| CBR 1000 | RR Fireblade (Rad.cal) | 06 - 08 | ● |
| CBR 1000 | RR Fireblade (Rad.cal) | 09 - | ● |
| SUZUKI | | | |
| GSX-R 600 | Brembo (Rad.cal) | 11 - | ● |
| GSX-R 750 | Brembo (Rad.cal) | 11 - | ● |
| GSX-R 1000 | K9 / L0 (Rad.cal) | 09 - | ● |

Street Sport Racing Enduro MX Off Road Racing ATV

A3+ XBK5

YAMAHA

FJR 1300 A / AS ABS 06 - 2 ●

1175

Dim./Size

→ 44,8 mm
↑ 53,6 mm
H 8,7 mm

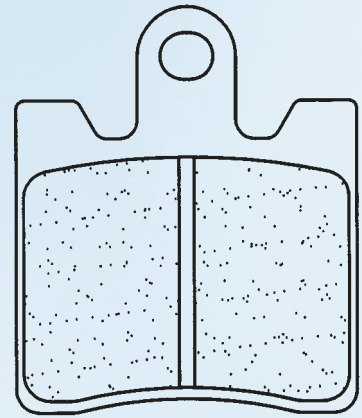

Street Sport Racing Enduro MX Off Road Racing ATV

A3+ XBK5 C59

KAWASAKI

| | | | | | |
|---------------|------|-----------------|---------|---|---|
| ZX6-R | 600 | Ninja (Rad.Cal) | 07 - | 2 | ● |
| Z | 750 | R | 11 - | 2 | ● |
| Z | 1000 | | 07 - 09 | 2 | ● |
| GTR | 1400 | (Rad.Cal) | 07 - | 2 | ● |
| ZZR | 1400 | (Rad.Cal) | 06 - | 2 | ● |
| SUZUKI | | | | | |
| GSX | 1300 | B-king | 07 | 2 | ● |

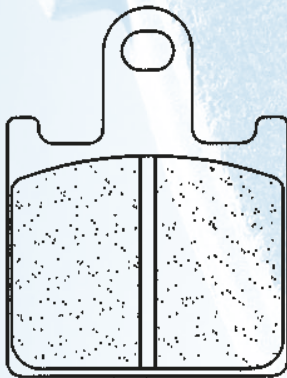

Dim./Size

→ 37,7 mm
↑ 49,9 mm
H 7,8 mm

1177

Street Sport Racing Enduro MX Off Road Racing ATV

A3+ XBK5 C59

YAMAHA

| | | | | | |
|-------|------|----------------------|---------|---|---|
| YZF | 1000 | R1 (Rad.cal) | 07 - 08 | 2 | ● |
| YZF | 1000 | R1 (Rad.cal) | 09 - | 2 | ● |
| MT-01 | 1700 | (6 piston caliper) | 07 - 09 | 2 | ● |
| MT-01 | 1700 | S (6 piston caliper) | 09 | 2 | ● |
| XV | 1700 | Y V-Max | 09 - | 2 | ● |

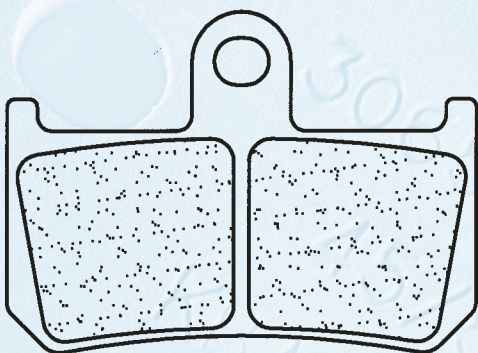

Dim./Size

→ 61,9 mm
↑ 44,8 mm
H 8,5 mm

1180

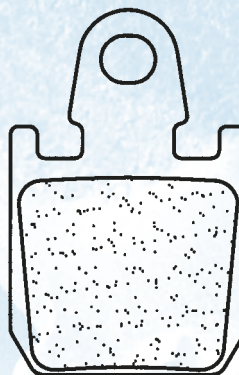

Dim./Size

→ 30,9 mm
↑ 48 mm
H 8,5 mm

Emballé par 4
Bon pour 1 étrier
Packed by 4 for
1 caliper

Street Sport Racing Enduro MX Off Road Racing ATV

MX10

YAMAHA

| | | | | |
|----|-----|------------------------|------|---|
| YZ | 125 | X / Y / Z | 08 - | ● |
| YZ | 250 | X / Y / Z (2T) | 08 - | ● |
| YZ | 250 | FW / FX / FY / FZ (4T) | 07 - | ● |
| YZ | 450 | FX / FY / FZ (4T) | 08 - | ● |

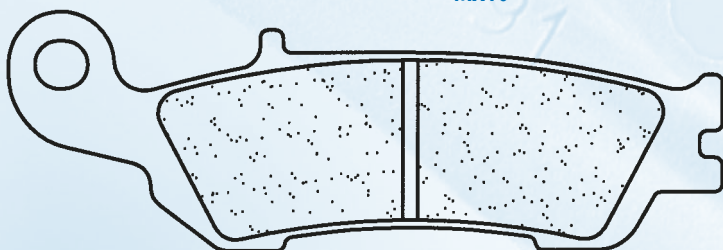

Dim./Size

→ 94 mm
↑ 31,5 mm
H 7 mm

1183

Street Sport Racing Enduro MX Off Road Racing ATV

ATV1

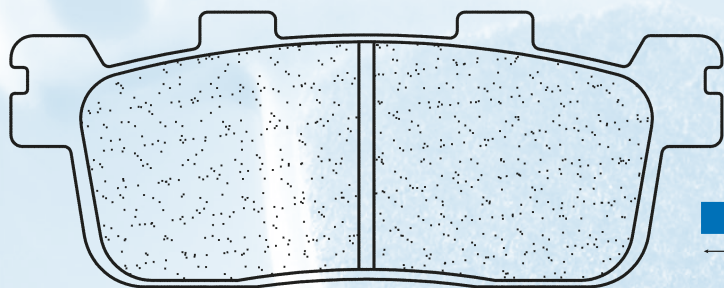

E-TON

| | | | | |
|-----|-----|-------------------|------|---|
| RXL | 150 | Viper | 07 - | ● |
| VXL | 250 | Vector, ST Vector | 06 - | ● |
| VTX | 300 | Vortex, ST Vortex | 07 - | ● |
| VXL | 300 | Vector, ST Vector | 07 - | ● |

SYM

| | | | | |
|--|-----|-------------|---------|---|
| | 200 | Trackrunner | 05 - 09 | ● |
| | 250 | Quadlander | 05 - 09 | ● |
| | 300 | Citymax | 06 - | ● |

Dim./Size

→ **93,9 mm**
↑ **36,2 mm**
H **10,5 mm**

1184

Street Sport Racing Enduro MX Off Road Racing ATV

A3+ XBK5 C59

1185

Dim./Size

→ **102 mm**
↑ **42 mm**
H **7,5 mm**

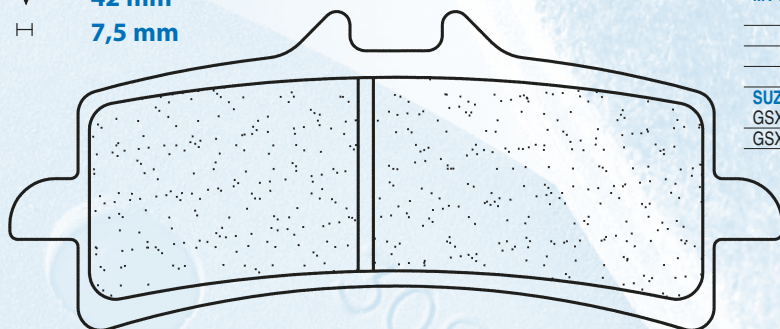

APRILIA

| | | | | | |
|------|------|---------|------|---|---|
| RSV4 | 1000 | Factory | 09 - | 2 | ● |
| RSV4 | 1000 | R | 10 - | 2 | ● |

BIMOTA

| | | | | | |
|-----|------|------------|------|---|---|
| DB7 | 1099 | (Rad. Cal) | 09 - | 2 | ● |
|-----|------|------------|------|---|---|

BMW

| | | | | | |
|-----|------|-------|------|---|---|
| HP2 | 1200 | Sport | 08 - | 2 | ● |
|-----|------|-------|------|---|---|

DUCATI

| | | | | | |
|-------|------|----------------------|---------|---|---|
| D16RR | 990 | Desmosedici RR | 07 | 2 | ● |
| | 1098 | / S | 07 - 08 | 2 | ● |
| | 1098 | R | 08 | 2 | ● |
| | 1098 | R Bayliss LE | 09 | 2 | ● |
| | 1098 | Streetfighter | 09 - | 2 | ● |
| | 1098 | Streetfighter S | 09 - | 2 | ● |
| | 1100 | Hypermotard S | 07 - | 2 | ● |
| | 1100 | Hypermotard Evo / SP | 10 - | 2 | ● |
| | 1198 | / S / R Corse | 09 - | 2 | ● |

KTM

| | | | | | |
|------|------|---|------|---|---|
| RC-8 | 1190 | | 08 - | 2 | ● |
| RC8 | 1190 | R | 09 - | 2 | ● |

MV AGUSTA

| | | | | | |
|--|------|--------------------|---------|---|---|
| | 998 | F4 | 10 - | 2 | ● |
| | 1078 | Brutale RR | 08 - 09 | 2 | ● |
| | 1078 | F4 RR 312 (Brembo) | 08 - | 2 | ● |
| | 1090 | Brutale RR | 10 - | 2 | ● |

SUZUKI

| | | | | | |
|-------|-----|------------------|------|---|---|
| GSX-R | 600 | Brembo (Rad.cal) | 11 - | 2 | ● |
| GSX-R | 750 | Brembo (Rad.cal) | 11 - | 2 | ● |

Street Sport Racing Enduro MX Off Road Racing ATV

XBK5 C59

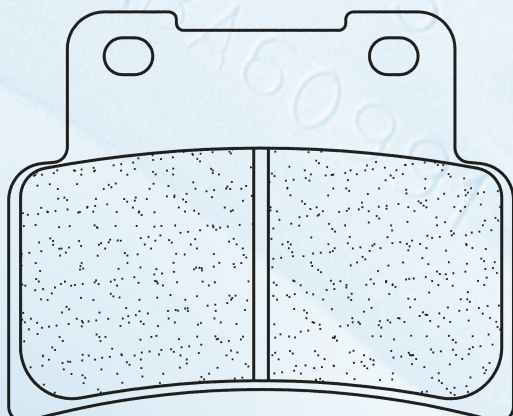

APRILIA

| | | | | | |
|-----|-----|-----------|------|---|---|
| RS | 125 | | 06 - | 1 | ● |
| | 750 | Shiver | 07 - | 2 | ● |
| | 750 | Shiver GT | 09 - | 2 | ● |
| SMV | 750 | Dorsoduro | 08 - | 2 | ● |
| NA | 850 | Mana | 07 | 2 | ● |
| NA | 850 | Mana | 08 - | 2 | ● |
| NA | 850 | Mana GT | 09 - | 2 | ● |

Dim./Size

→ **68,5 mm**
↑ **55,5 mm**
H **9 mm**

1187

Street Sport Racing Enduro MX Off Road Racing ATV

ATV1

1192

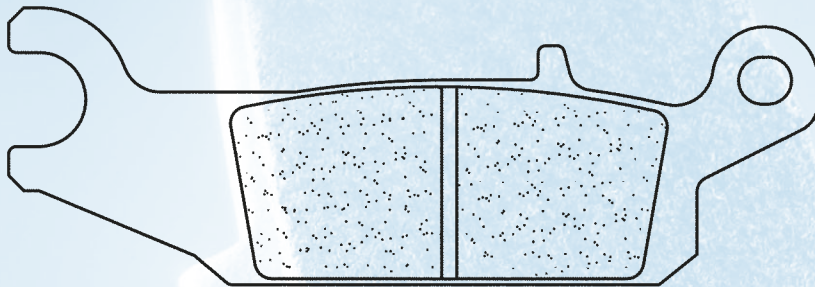

Dim./Size
 — 107 mm
 ↓ 36,5 mm
 H 7,5 mm

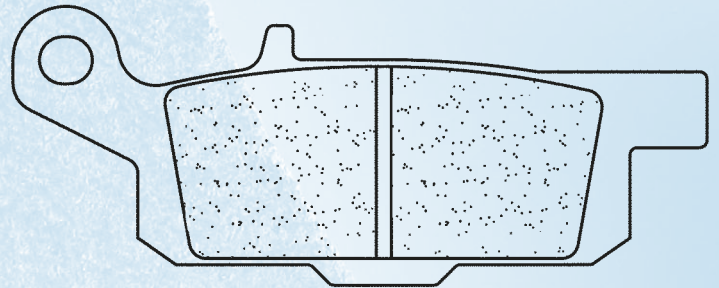

Dim./Size
 — 91,7 mm
 ↓ 36,7 mm
 H 7,5 mm

YAMAHA

| | | | |
|---------|-------------|--------|-----|
| YFM 250 | R Raptor | 08 - R | 1 ● |
| YFM 450 | Grizzly EPS | 07 - R | 1 ● |
| YFM 550 | Grizzly EPS | 07 - R | 1 ● |
| YFM 700 | Grizzly EPS | 07 - R | 1 ● |

Street Sport Racing Enduro MX Off Road Racing ATV

ATV1

1193

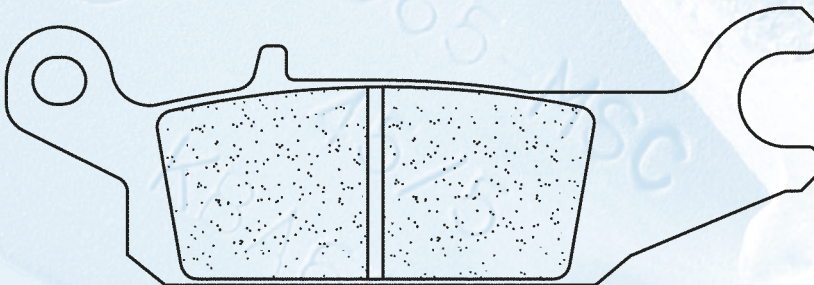

Dim./Size
 — 107 mm
 ↓ 36,5 mm
 H 7,5 mm

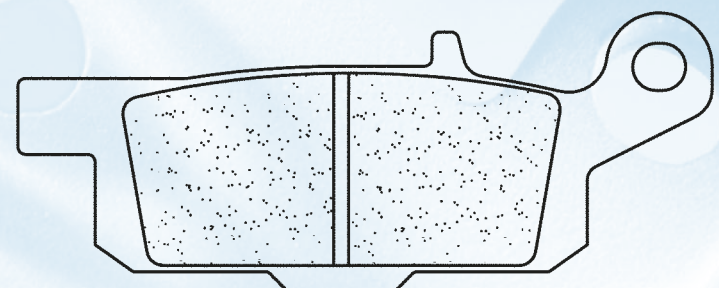

Dim./Size
 — 91,7 mm
 ↓ 36,7 mm
 H 7,5 mm

YAMAHA

| | | | |
|---------|-------------|--------|-----|
| YFM 250 | R Raptor | 08 - L | 1 ● |
| YFM 450 | Grizzly EPS | 07 - L | 1 ● |
| YFM 550 | Grizzly EPS | 07 - L | 1 ● |
| YFM 700 | Grizzly EPS | 07 - L | 1 ● |

Street Sport Racing Enduro MX Off Road Racing ATV

ATV1

1194

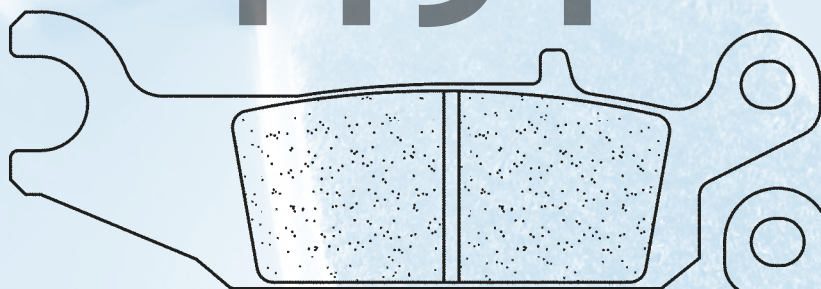

Dim./Size
 — 107 mm
 ↓ 36,5 mm
 H 8,9 mm

Dim./Size
 — 91,7 mm
 ↓ 36,7 mm
 H 8,9 mm

YAMAHA

| | | | | |
|---------|-------------|--------|---|---|
| YFM 450 | Grizzly EPS | 07 - R | 1 | ● |
| YFM 550 | Grizzly EPS | 07 - R | 1 | ● |
| YFM 700 | Grizzly EPS | 07 - R | 1 | ● |

Street Sport Racing Enduro MX Off Road Racing ATV

ATV1

1195

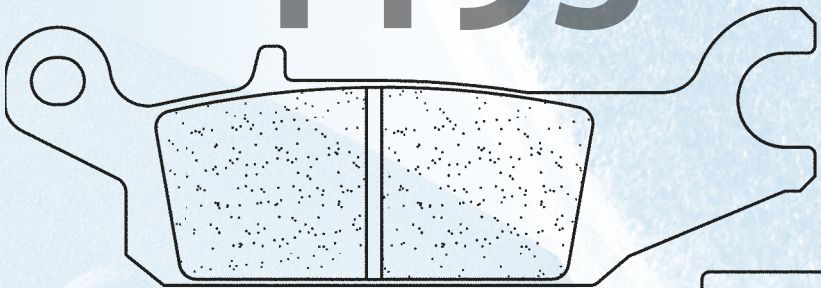

Dim./Size
 — 107 mm
 ↓ 36,5 mm
 H 8,9 mm

Dim./Size
 — 91,7 mm
 ↓ 36,7 mm
 H 8,9 mm

YAMAHA

| | | | | |
|---------|-------------|--------|---|---|
| YFM 450 | Grizzly EPS | 07 - L | 1 | ● |
| YFM 550 | Grizzly EPS | 07 - L | 1 | ● |
| YFM 700 | Grizzly EPS | 07 - L | 1 | ● |

Street Sport Racing Enduro MX Off Road Racing ATV

RX3

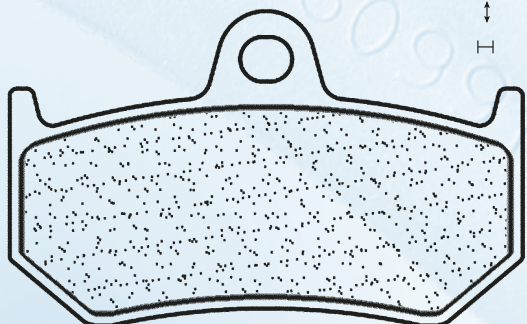

Dim./Size
 — 69,4 mm
 ↓ 42,5 mm
 H 7,5 mm

MV AGUSTA

| | | | | |
|------|-------------------------------|---------|---|---|
| 750 | Brutale (All Models) (Nissin) | 03 - 08 | 2 | ● |
| 750 | F4 (All Models) (Nissin) | 99 - 03 | 2 | ● |
| 910 | Brutale S (Nissin) | 05 - 08 | 2 | ● |
| 910 | Brutale R (Brembo) | 05 - 08 | 4 | ● |
| 989 | Brutale R | 08 - 09 | 2 | ● |
| 920 | Brutale | 11 - | 2 | ● |
| 990 | Brutale R | 10 - | 2 | ● |
| 998 | F4 | 10 - | 2 | ● |
| 1000 | F4 (All Models) (Nissin) | 04 - 06 | 2 | ● |
| 1000 | F4 Senna | 06 | 4 | ● |
| 1000 | F4 R (Brembo) | 06 - 07 | 4 | ● |
| 1000 | F4 RR 312 (Brembo) | 07 | 2 | ● |
| 1078 | Brutale RR | 08 - 09 | 2 | ● |
| 1078 | F4 RR 312 (Brembo) | 08 - | 2 | ● |
| 1090 | Brutale RR | 10 - | 2 | ● |

1203

Street Sport Racing Enduro MX Off Road Racing ATV

ATV1

1204

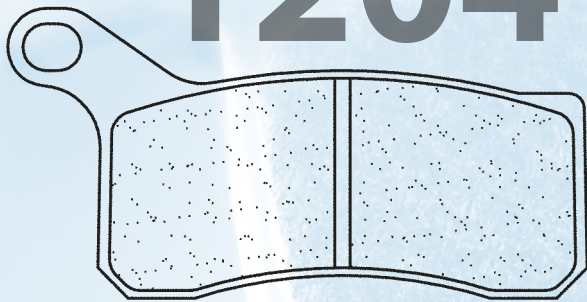

Dim./Size
 ← 76,5 mm
 ↑↓ 38,2 mm
 H 7,5 mm

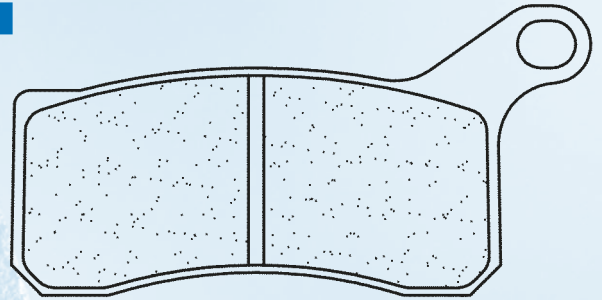

| KTM | | | | |
|---------|-----|-----|------|-----|
| SX / XC | 450 | ATV | 08 - | 2 ● |
| SX / XC | 505 | ATV | 08 - | 2 ● |
| SX / XC | 525 | ATV | 08 - | 2 ● |

Street Sport Racing Enduro MX Off Road Racing ATV

X59 ATV1

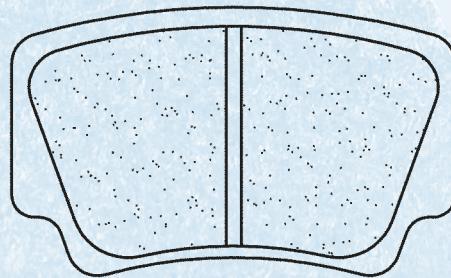
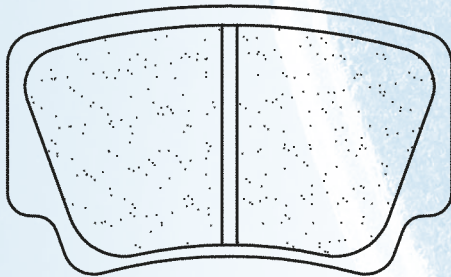

Dim./Size
 ← 58,7 mm
 ↑↓ 35,4 mm
 H 8,4 mm

1205

| KTM | | | | |
|---------|-----|-----|------|-----|
| SX / XC | 450 | ATV | 08 - | 1 ● |
| SX / XC | 505 | ATV | 08 - | 1 ● |
| SX / XC | 525 | ATV | 08 - | 1 ● |

Street Sport Racing Enduro MX Off Road Racing ATV

XBK5 C59

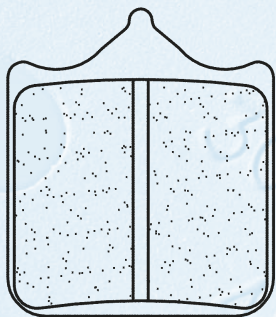

1207

Dim./Size
 ← 35 mm
 ↑↓ 40,5 mm
 H 8,5 mm
 H 4,5 mm

⚠ **Tôle / Backplate**

| BMW | | | | |
|-----|------|----|------|-----|
| S | 1000 | RR | 09 - | 2 ● |

Street Sport Racing Enduro MX Off Road Racing ATV

XBK5 C59

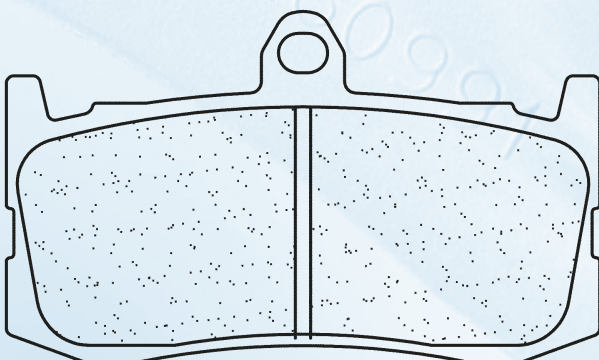

1209

Dim./Size
 ← 78,4 mm
 ↑↓ 31,5 mm
 H 8 mm

| TRIUMPH | | | | |
|---------|-------------------|--|------|-----|
| 675 | Daytona (Rad.cal) | | 09 - | 2 ● |

Street Sport Racing Enduro MX Off Road Racing ATV

RX3

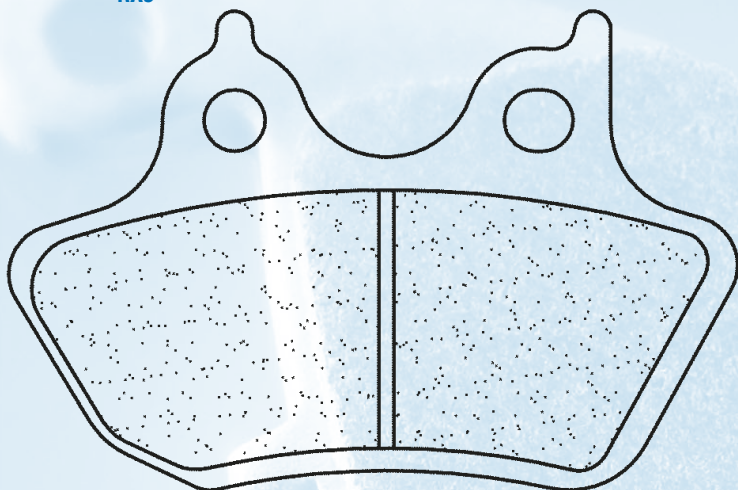

1211

Dim./Size
 — 97,6 mm
 ↑ 64 mm
 H 8 mm

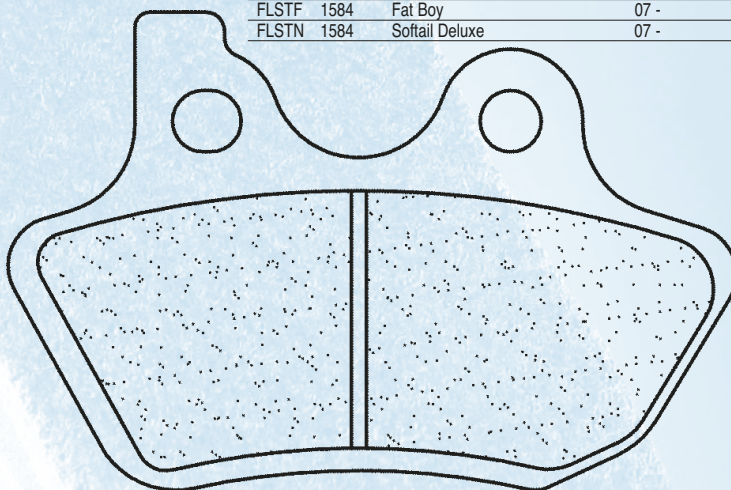

HARLEY DAVIDSON

| | | | | |
|---------|------|------------------------------|---------|---|
| FLSTI | 1450 | Heritage Softail | 06 - | ● |
| FXDI | 1450 | 35th Anniversary Super Glide | 06 - | ● |
| FXSTI | 1450 | Softail Standard | 05 - 06 | ● |
| FXSTBI | 1450 | Night Train | 06 - | ● |
| FXSTDI | 1450 | Softail Deuce | 05 - 06 | ● |
| FXSTSI | 1450 | Softail | 06 - | ● |
| FLSTC | 1584 | Heritage Softail Classic | 07 - | ● |
| FLSTF | 1584 | Fat Boy | 07 - | ● |
| FLSTN | 1584 | Softail Deluxe | 07 - | ● |
| FLSTSCI | 1584 | Softail | 07 - | ● |
| FXD | 1584 | Dyna Super Glide | 07 - | ● |
| FXDB | 1584 | Dyna Street Bob | 07 - | ● |
| FXDC | 1584 | Dyna Super Glide Custom | 07 - | ● |
| FXDL | 1584 | Dyna Low Rider | 07 - | ● |
| FXDWG | 1584 | Dyna Wide Glide | 07 - | ● |
| FXST | 1584 | Softail Standard | 07 - | ● |
| FXSTB | 1584 | Night Train | 07 - | ● |
| FXSTC | 1584 | Softail Custom | 07 - | ● |
| FXSTD | 1584 | Softail Deuce | 07 - | ● |
| FLHR | 1584 | Road King | 07 - | ● |
| FLHRC | 1584 | Road King Classic | 07 - | ● |
| FLHRS | 1584 | Road King Custom | 07 - | ● |
| FLHTC | 1584 | Electra Glide Classic | 07 - | ● |
| FLHT | 1584 | Electra Glide Standard | 07 - | ● |
| FLHTCU | 1584 | Ultra Classic Electra Glide | 07 - | ● |
| FLHX | 1584 | Street Glide | 07 - | ● |
| FLSTF | 1584 | Fat Boy | 07 - | ● |
| FLSTN | 1584 | Softail Deluxe | 07 - | ● |



Street Sport Racing Enduro MX Off Road Racing ATV

A3+

1212

Dim./Size
 — 90,5 mm
 ↑ 62 mm
 H 8 mm

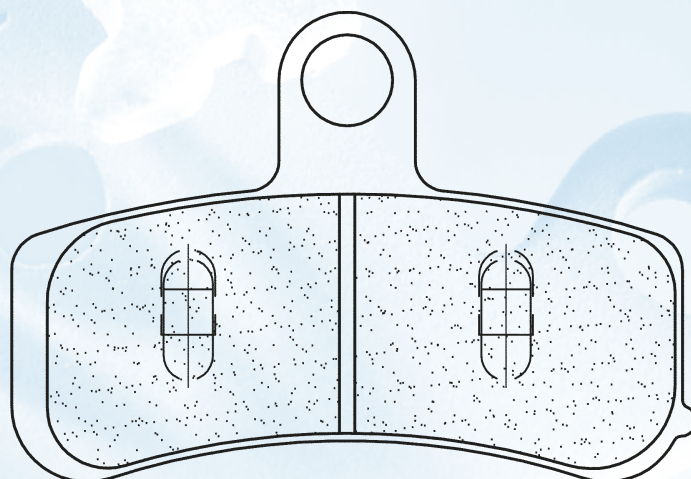
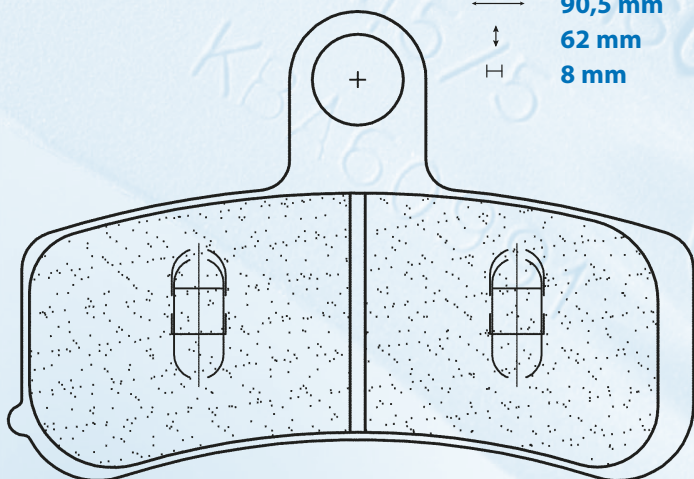

HARLEY DAVIDSON

| | | | | | |
|-------|------|--------------------------|------|---|---|
| FLSTC | 1584 | Heritage Softail Classic | 08 - | 1 | ● |
| FLSTF | 1584 | Fat Boy | 08 - | 1 | ● |
| FLSTN | 1584 | Softail Deluxe | 08 - | 1 | ● |
| FXCW | 1584 | Rocker | 08 - | 1 | ● |
| FXCWC | 1584 | Rocker C | 08 - | 1 | ● |
| FXD | 1584 | Dyna Super Glide | 08 - | 1 | ● |
| FXDB | 1584 | Dyna Street Bob | 08 - | 1 | ● |
| FXDC | 1584 | Dyna Super Glide Custom | 08 - | 1 | ● |
| FXDF | 1584 | Fat Bob | 08 - | 1 | ● |
| FXDL | 1584 | Dyna Low Rider | 08 - | 1 | ● |
| FXDWG | 1584 | Dyna Wide Glide | 08 - | 1 | ● |
| FXST | 1584 | Softail Standard | 08 - | 1 | ● |
| FXSTB | 1584 | Night Train | 08 - | 1 | ● |
| FXSTC | 1584 | Softail Custom | 08 - | 1 | ● |



Street Sport Racing Enduro MX Off Road Racing ATV

RX3

1213

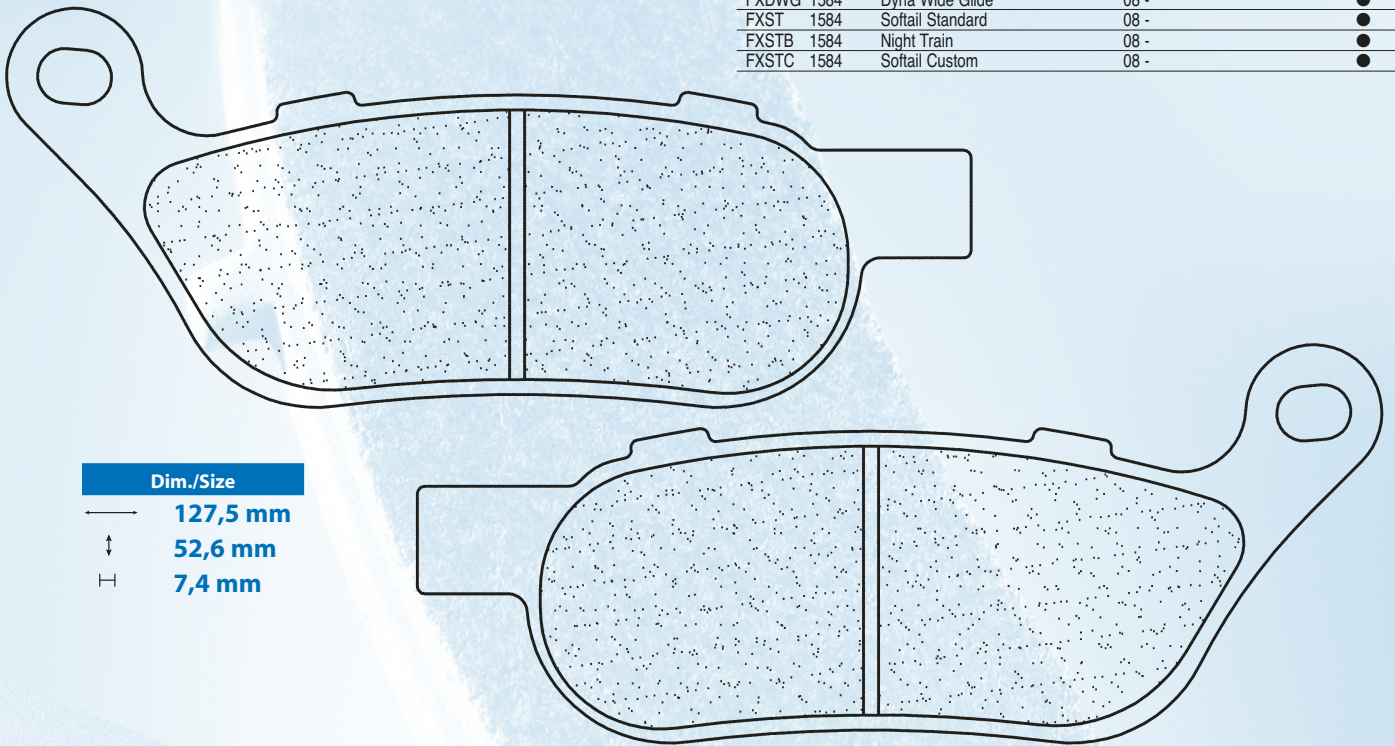

| Dim./Size | |
|-----------|----------|
| — | 127,5 mm |
| ↑ ↓ | 52,6 mm |
| H | 7,4 mm |

HARLEY DAVIDSON

| | | | | |
|-------|------|--------------------------|------|---|
| FLSTC | 1584 | Heritage Softail Classic | 08 - | ● |
| FLSTF | 1584 | Fat Boy | 08 - | ● |
| FLSTN | 1584 | Softail Deluxe | 08 - | ● |
| FXCW | 1584 | Rocker | 08 - | ● |
| FXCWC | 1584 | Rocker C | 08 - | ● |
| FXD | 1584 | Dyna Super Glide | 08 - | ● |
| FXDB | 1584 | Dyna Street Bob | 08 - | ● |
| FXDC | 1584 | Dyna Super Glide Custom | 08 - | ● |
| FXDF | 1584 | Fat Bob | 08 - | ● |
| FXDL | 1584 | Dyna Low Rider | 08 - | ● |
| FXDWG | 1584 | Dyna Wide Glide | 08 - | ● |
| FXST | 1584 | Softail Standard | 08 - | ● |
| FXSTB | 1584 | Night Train | 08 - | ● |
| FXSTC | 1584 | Softail Custom | 08 - | ● |

Street Sport Racing Enduro MX Off Road Racing ATV

A3+ XBK5

HONDA

| | | | | | |
|-----|------|---|------|---|---|
| VFR | 1200 | F | 10 - | 2 | ● |
|-----|------|---|------|---|---|

1216

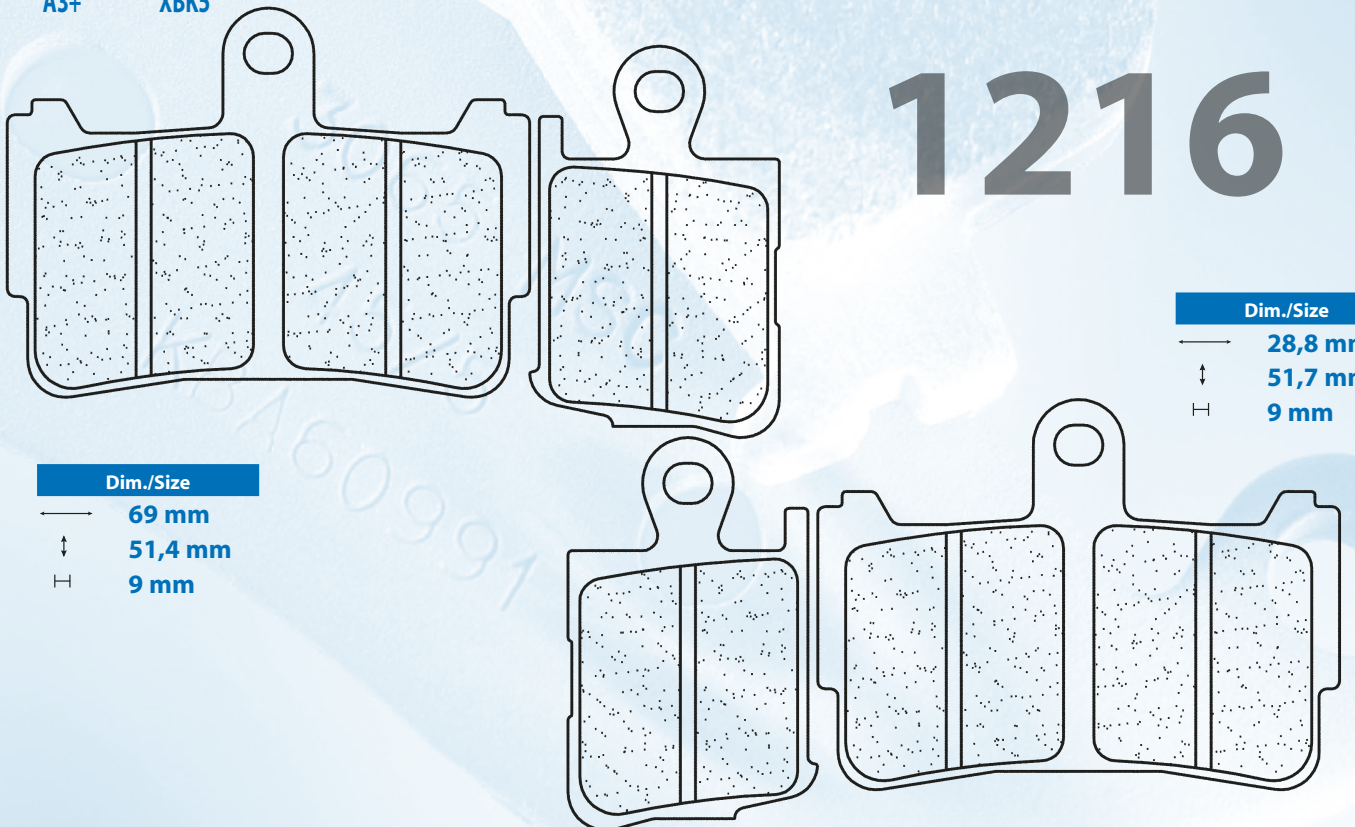

| Dim./Size | |
|-----------|---------|
| — | 69 mm |
| ↑ ↓ | 51,4 mm |
| H | 9 mm |

| Dim./Size | |
|-----------|---------|
| — | 28,8 mm |
| ↑ ↓ | 51,7 mm |
| H | 9 mm |

Street Sport Racing Enduro MX Off Road Racing ATV

RX3

HONDA

| | | | | |
|-----|------|-----------------|------|---|
| CB | 1000 | R (Rad.cal) | 08 - | |
| CB | 1000 | R (Rad.cal) ABS | 08 - | ● |
| VFR | 1200 | F | 10 - | ● |

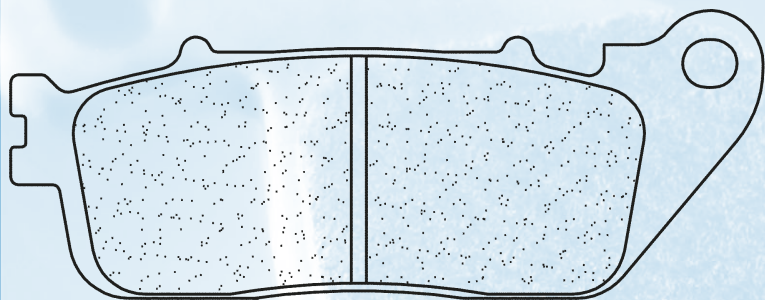

1217

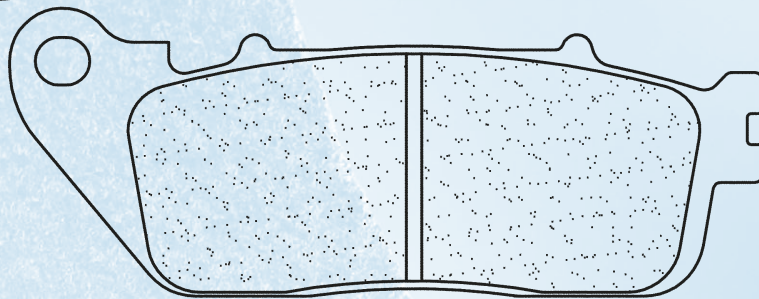

Dim./Size

— 99,4 mm
↑ 38 mm
H 9 mm

Street Sport Racing Enduro MX Off Road Racing ATV

X59

KTM
SX

85

11 -

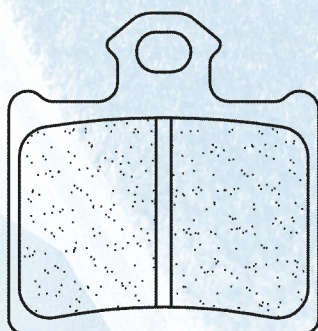
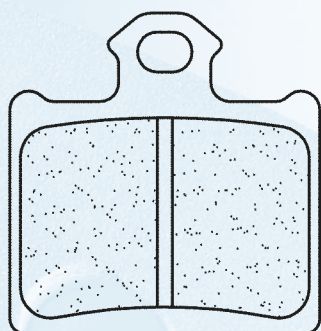

1219

Dim./Size

— 41 mm
↑ 42,3 mm
H 7,3 mm

Street Sport Racing Enduro MX Off Road Racing ATV

ATV1

1220

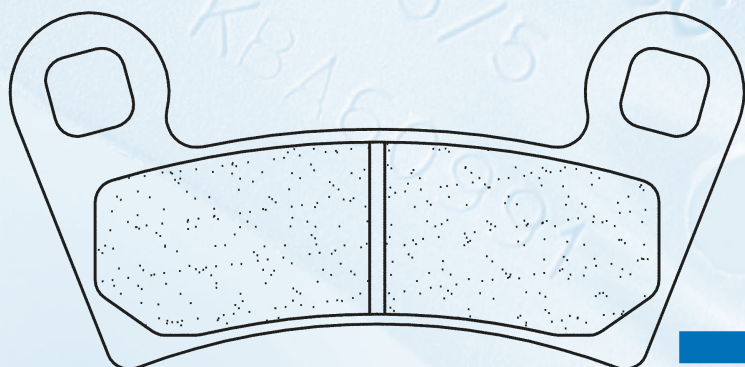

POLARIS

| | | | | |
|-----|------------|---------|---|---|
| 450 | Outlaw S | 08 | 2 | ● |
| 450 | Outlaw MXR | 09 - 10 | 2 | ● |
| 525 | Outlaw S | 08 - 10 | 2 | ● |
| 525 | Outlaw IRS | 08 - 10 | 2 | ● |

Dim./Size

— 97 mm
↑ 47 mm
H 7,6 mm

Street Sport Racing Enduro MX Off Road Racing ATV

ATV1

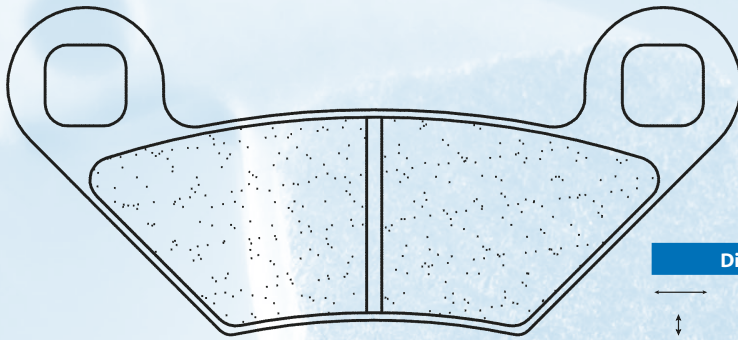

POLARIS

| | | | | | |
|-----|------------------|---------|---|---|---|
| 500 | XP Sportsman | 09 | 2 | ● | ● |
| 550 | XP Sportsman EPS | 09 - 10 | 2 | ● | ● |
| 550 | Sportsman X2 | 10 | 2 | ● | ● |
| 850 | XP Sportsman | 09 - 10 | 2 | ● | ● |
| 850 | XP ES Sportsman | 09 - 10 | 2 | ● | ● |

Dim./Size

→ 96,9 mm
↑↓ 43,2 mm
H 7,6 mm

1222

Street Sport Racing Enduro MX Off Road Racing ATV

A3+ RX3

YAMAHA

| | | | | | | |
|----|-----|---------------|------|---|---|---|
| XT | 125 | R | 05 - | 1 | ● | ● |
| XT | 125 | X Supermotard | 05 - | | | ● |

1223

Dim./Size

→ 49,8 mm
↑↓ 47 mm
H 7 mm

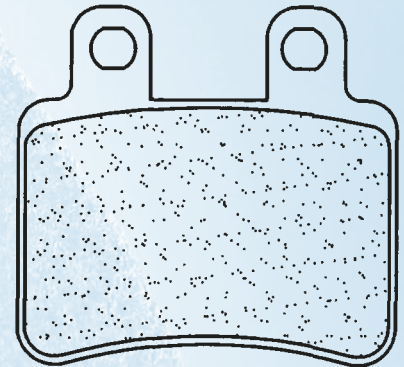

Street Sport Racing Enduro MX Off Road Racing ATV

S4 A3+

YAMAHA

| | | | | | | |
|-----|-----|----------|------|---|---|---|
| YBR | 125 | (3D92/9) | 07 - | 1 | ● | ● |
| YBR | 125 | Custom | 08 - | 1 | ● | ● |

1224

Dim./Size

→ 95,6 mm
↑↓ 37,5 mm
H 8,5 mm

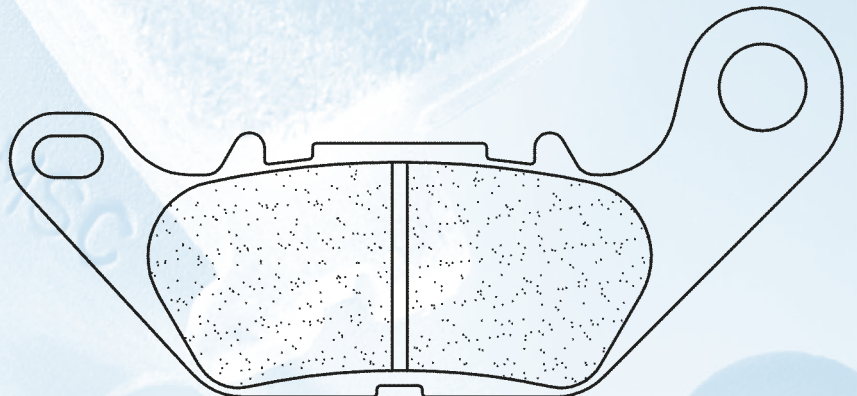

Dim./Size

→ 109,9 mm
↑↓ 51,4 mm
H 8,5 mm

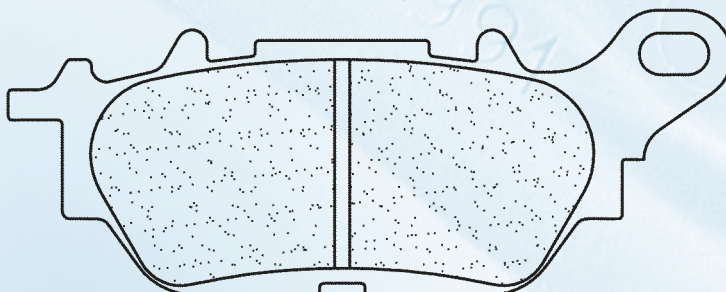

Street Sport Racing Enduro MX Off Road Racing ATV

S4 A3+ XBK5 C59

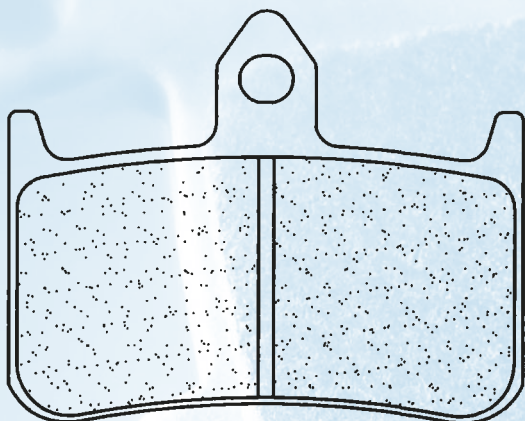

Dim./Size
 → 67,7 mm
 ↑ 54 mm
 H 8 mm

2245

HONDA

| | | | | | |
|-----|------|--------------------------|---------|---|---|
| NS | 125 | | 89 | 1 | ● |
| NS | 250 | | 89 | 1 | ● |
| NSR | 250 | RJ | 88 - | 2 | ● |
| NSR | 250 | R / SP | 90 | 2 | ● |
| RS | 250 | R | 91 - 92 | 2 | ● |
| NTV | 400 | Bros II | 88 | 1 | ● |
| RVF | 400 | RR (NC35) | 90 - 96 | 2 | ● |
| VFR | 400 | R NC30 | 89 - | 2 | ● |
| VTR | 400 | R | 90 | 2 | ● |
| NTV | 600 | Bros | 88 - | 1 | ● |
| NTV | 650 | Bros | 88 - | 2 | ● |
| NR | 750 | | 92 | 2 | ● |
| RVF | 750 | RR (RC45) | 94 - | 2 | ● |
| VFR | 750 | R (RC 30) | 88 - 93 | 2 | ● |
| CB | 900 | Hornet (919) | 02 - | 2 | ● |
| CBR | 900 | RR Fireblade | 92 - 97 | 2 | ● |
| CB | 1000 | F Big One | 93 - 97 | 2 | ● |
| VTR | 1000 | F Firestorm / Super Hawk | 97 - 06 | 2 | ● |
| CB | 1300 | X-4 | 97 - 00 | 2 | ● |

Street Sport Racing Enduro MX Off Road Racing ATV

A3+ XBK5 C59

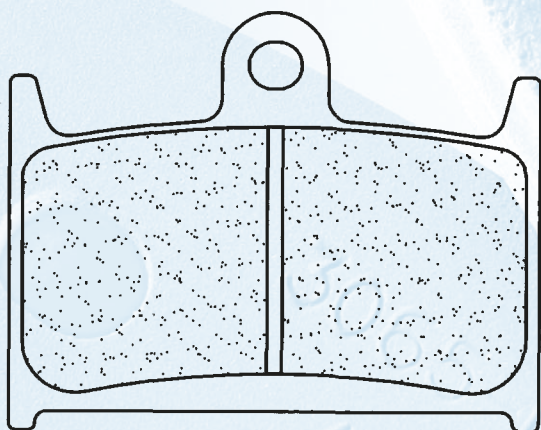

Dim./Size
 → 69,8 mm
 ↑ 55,1 mm
 H 8,5 mm

2246

NISSIN

| | | 4 Piston Caliper - Road/Racing | | 1 | ● |
|----------------|------|--------------------------------|---------|---|---|
| SUZUKI | | | | | |
| GSX-R | 400 | RL/RM/RN/RS (GK76A) | 90 - 95 | 2 | ● |
| GSX-R | 600 | | 93 - 96 | 2 | ● |
| GSX-R | 750 | RG | 86 | 2 | ● |
| GSX-R | 750 | J / K / L / M / WN / WP | 88 - 93 | 2 | ● |
| GSX | 1100 | Katana | 93 - | 2 | ● |
| GSX-R | 1100 | K / L / M / N (GV73B) | 89 - 92 | 2 | ● |
| GSF | 1200 | S / N Bandit | 95 - 00 | 2 | ● |
| GSF | 1200 | S / N Bandit ABS | 97 - | 2 | ● |
| TRIUMPH | | | | | |
| | 600 | Daytona | 03 - 04 | 2 | ● |
| | 600 | Speed Four | 02 - 05 | 2 | ● |
| | 600 | TT | 00 - 03 | 2 | ● |
| | 650 | Daytona | 05 | 2 | ● |
| | 750 | Daytona | 91 - 92 | 2 | ● |
| | 900 | Daytona | 93 - 96 | 2 | ● |
| | 900 | Speed Triple | 94 - 96 | 2 | ● |
| T 509 | 900 | Speed Triple | 97 - 98 | 2 | ● |
| | 900 | Sprint | 94 - 98 | 2 | ● |
| | 900 | Sprint Sport Edition | 97 - 98 | 2 | ● |
| | 900 | Trophy | 96 - | 2 | ● |
| T 595 | 950 | Daytona | 97 - 98 | 2 | ● |
| | 955 | Daytona | 99 - 06 | 2 | ● |
| | 955 | Daytona Centennial | 02 | 2 | ● |
| | 955 | Speed Triple | 99 - 04 | 2 | ● |
| | 955 | Sprint RS | 99 - 04 | 2 | ● |
| | 955 | Sprint ST | 99 - 04 | 2 | ● |
| | 1000 | Daytona | 91 - 95 | 2 | ● |
| | 1050 | Sprint ST | 05 - 09 | 2 | ● |
| | 1050 | Sprint ST ABS | 09 - | 2 | ● |
| | 1200 | Daytona | 93 - 98 | 2 | ● |
| | 1200 | Trophy | 96 - 03 | 2 | ● |
| | 1600 | Thunderbird | 09 - | 2 | ● |
| | 2300 | Rocket III | 04 - | 2 | ● |
| | 2300 | Rocket III Classic | 07 - | 2 | ● |
| | 2300 | Rocket III Roadster | 10 - | 2 | ● |
| YAMAHA | | | | | |
| TZ | 125 | | 97 - | 1 | ● |
| TZ | 250 | GP / A / D | 90 - 95 | 2 | ● |
| FZR | 750 | R (OW01) | 89 - 90 | 2 | ● |

MZ / MUZ

| | | | | |
|------|-----|---------|---|---|
| 1000 | S | 03 - 07 | 2 | ● |
| 1000 | SF | 05 - 07 | 2 | ● |
| 1000 | SFX | 07 - | 2 | ● |
| 1000 | SN | 05 - | 2 | ● |
| 1000 | ST | 07 - | 2 | ● |

Street Sport Racing Enduro MX Off Road Racing ATV

S4 A3+ RX3 XBK5 C59

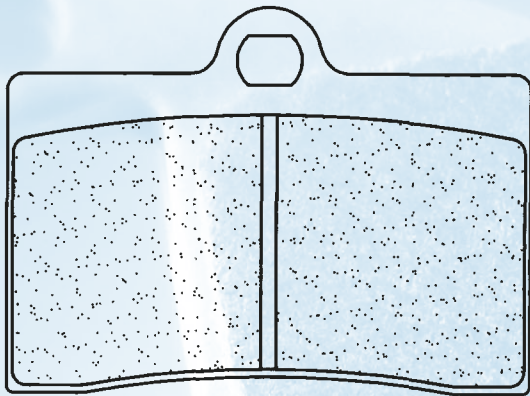

2247

Dim./Size

69,4 mm

50,8 mm

8 mm

APRILIA

| | | | | | |
|----|-----|--|---------|---|---|
| RS | 250 | | 95 - 96 | 1 | ● |
|----|-----|--|---------|---|---|

BETA

| | | | | | |
|--|-----|------------|------|---|---|
| | 125 | Jonathan | 99 - | 1 | ● |
| | 350 | 4.0 Motard | 04 - | 1 | ● |
| | 350 | Euro | 99 - | 1 | ● |
| | 350 | Jonathan | 02 - | 1 | ● |
| | 350 | M4 | 06 - | 1 | ● |

BIMOTA

| | | | | | |
|--|-------|-------------------|---------|---|---|
| | YB7 | | 89 | 2 | ● |
| | V Due | TESI 2 | 97 - | 2 | ● |
| | 600 | Bellaria | 91 - | 2 | ● |
| | YB9 | 600 SRI | 96 - | 2 | ● |
| | BB1 | 650 Supermono | 96 - | 2 | ● |
| | SB7 | 750 | 96 - | 2 | ● |
| | YB4 | 750 | 89 | 2 | ● |
| | 1D | 851 Tesi | 91 - 95 | 2 | ● |
| | | 900 Mantra | 96 - | 2 | ● |
| | DB2 | 900 | 92 - | 2 | ● |
| | 1D | 904 Tesi SR / ES | 96 - | 2 | ● |
| | DB2 | 904 HF / SR | 96 - | 2 | ● |
| | 1D | 906 Tesi | 91 - 95 | 2 | ● |
| | 2D | 1000 Tesi | 04 - 06 | 2 | ● |
| | YB11 | 1000 | 97 - | 2 | ● |
| | YB6 | 1000 | 89 | 2 | ● |
| | YB8 | 1000 | 90 - 95 | 2 | ● |
| | YB11 | 1002 Dieci | 91 - 95 | 2 | ● |
| | YB11 | 1002 Superleggera | 96 | 2 | ● |
| | SB6 | 1100 | 96 - | 2 | ● |
| | SB6 | 1100 R | 97 - | 2 | ● |
| | 1D | Tesi | 93 - | 2 | ● |
| | DB2 | | 92 - | 2 | ● |
| | | All models | 89 - 98 | 2 | ● |
| | | Furano | 92 - | 2 | ● |

BORILE

| | | | | | |
|---|-----|----|------|---|---|
| B | 500 | CR | 02 - | 1 | ● |
| B | 500 | MT | 02 - | 1 | ● |

BREMBO

| | | | | | |
|--|--|-----------------------------------|--|---|---|
| | | P4 34x30 Single pin - Road/Racing | | 1 | ● |
|--|--|-----------------------------------|--|---|---|

CAGIVA

| | | | | | |
|----|-----|--------------|---------|---|---|
| | 125 | Mito | 93 - | 1 | ● |
| | 125 | Mito EV / SP | 95 - | 1 | ● |
| | 125 | Planet | 98 - 02 | 1 | ● |
| | 125 | Raptor | 03 - | 1 | ● |
| | 500 | Mito | 07 | 1 | ● |
| | 500 | River | 00 - | 1 | ● |
| SP | 525 | Mito | 08 - | 1 | ● |
| | 600 | River | 94 - 95 | 1 | ● |

CANNONDALE

| | | | | | |
|---|-----|----|------|---|---|
| S | 440 | SM | 03 - | 1 | ● |
|---|-----|----|------|---|---|

DUCATI

| | | | | | |
|--|-----|-----------------------|---------|---|---|
| | 400 | SS Junior | 92 | 2 | ● |
| | 400 | SS Nuda | 92 - | 1 | ● |
| | 502 | Single | 93 | 2 | ● |
| | 502 | Supermono | 93 | 2 | ● |
| | 600 | Monster | 94 - 99 | 1 | ● |
| | 600 | Supersport | 94 - 95 | 1 | ● |
| | 600 | Supersport | 96 - 02 | 1 | ● |
| | 748 | Biposto / SP / Strada | 95 - 99 | 2 | ● |
| | 750 | Carenara / Nuda | 92 - | 1 | ● |
| | 750 | Monster | 96 - 99 | 2 | ● |
| | 750 | Supersport | 91 - 94 | 2 | ● |

DUCATI

| | | | | | |
|-----|-----|---------------------|---------|---|---|
| | 750 | Supersport | 95 - 99 | 2 | ● |
| | 851 | Strada | 89 | 2 | ● |
| | 851 | Strada | 91 - | 2 | ● |
| | 851 | Superbike | 90 | 2 | ● |
| | 888 | Roche Replica | 91 - | 2 | ● |
| | 888 | SPO | 93 | 2 | ● |
| | 888 | SPS / SP4 | 92 - | 2 | ● |
| | 888 | SPV | 92 - 94 | 2 | ● |
| | 888 | Strada / Superbike | 93 | 2 | ● |
| 906 | 900 | Paso | 89 | 2 | ● |
| 907 | 900 | I. E. | 92 | 2 | ● |
| | 900 | Monster IL | 93 - 99 | 2 | ● |
| | 900 | SSR | 92 | 2 | ● |
| | 900 | Superlight | 92 - 95 | 1 | ● |
| | 900 | Supersport | 90 - 94 | 2 | ● |
| | 900 | Supersport | 95 - 97 | 2 | ● |
| | 916 | Biposto | 94 - 97 | 2 | ● |
| | 916 | SP / Strada / Senna | 94 - 97 | 2 | ● |

GAS GAS

| | | | | | |
|----|-----|-----|---------|---|---|
| SM | 125 | | 02 - | 1 | ● |
| SM | 250 | | 02 - | 1 | ● |
| SM | 400 | fse | 03 - | 1 | ● |
| SM | 450 | fse | 03 - 06 | 1 | ● |
| SM | 450 | fsr | 07 - | 1 | ● |

GILERA

| | | | | | |
|--|-----|------------------|------|---|---|
| | 350 | Saturno Bialbero | 90 - | 1 | ● |
| | 500 | Saturno Bialbero | 90 - | 1 | ● |
| | 500 | Saturno Pluma | 90 - | 1 | ● |

HUSQVARNA

| | | | | | |
|-----|-----|---|---------|---|---|
| SM | 400 | R | 02 | 1 | ● |
| SM | 450 | R | 03 - 04 | 1 | ● |
| SM | 510 | R | 05 | 1 | ● |
| SM | 570 | R | 01 - 05 | 1 | ● |
| SM | 570 | R | 06 | 1 | ● |
| SMR | 630 | | 04 - 05 | 1 | ● |
| SMR | 630 | | 06 - | 1 | ● |

ITALJET

| | | | | | |
|--|-----|---------|------|---|---|
| | 900 | Griffon | 00 - | 1 | ● |
|--|-----|---------|------|---|---|

KTM

| | | | | | |
|-----|-----|-------------------------|---------|---|---|
| | 125 | Sting | 97 - | 1 | ● |
| SX | 450 | SM / SM Factory Replica | 04 - | 1 | ● |
| | 620 | Duke | 94 - 98 | 1 | ● |
| LC4 | 660 | SM Factory Replica | 02 - | 1 | ● |
| | 660 | SMC | 03 - 04 | 1 | ● |

LAVERDA

| | | | | | |
|--|-----|------------------------|------|---|---|
| | 650 | Ghost | 96 - | 2 | ● |
| | 650 | Ghost Legend | 97 - | 2 | ● |
| | 650 | Sport | 92 - | 2 | ● |
| | 650 | Strike | 97 - | 2 | ● |
| | 668 | Diamante | 97 - | 2 | ● |
| | 668 | Ghost Strike | 98 - | 2 | ● |
| | 668 | | 96 - | 2 | ● |
| | 750 | Cup | 98 - | 2 | ● |
| | 750 | Diamante | 97 - | 2 | ● |
| | 750 | Ghost Strike | 97 - | 2 | ● |
| | 750 | S / S Formula / Strike | 97 - | 2 | ● |
| | 750 | S SPORT | 99 - | 2 | ● |

LAVERDA

| | | | | | |
|-----|-----|--|------|---|---|
| TTS | 800 | | 99 - | 2 | ● |
|-----|-----|--|------|---|---|

MOTO GUZZI

| | | | | | |
|-----|------|--------------------------------------------|---------|---|---|
| V7 | 750 | Ippogrifo | 97 - | 2 | ● |
| | 1000 | Daytona | 91 - | 2 | ● |
| RS | 1000 | Daytona | 97 - | 2 | ● |
| V10 | | Centaur | 97 - 99 | 2 | ● |
| | 1100 | California Jackal (Single pin pad fixing) | 99 - 01 | 2 | ● |
| | 1100 | California Special (Single pin pad fixing) | 99 - 00 | 2 | ● |
| | 1100 | California EV (Single pin pad fixing) | 97 - 00 | 2 | ● |
| | 1100 | Sport | 94 - 99 | 2 | ● |
| | 1100 | Sport Corsa | 98 - 99 | 2 | ● |
| V11 | 1100 | Sport | 97 - 00 | 2 | ● |

MZ / MUZ

| | | | | | |
|--|-----|---------------------------|---------|---|---|
| | 660 | Mastiff 17" | 99 - 05 | 1 | ● |
| | 660 | Skorpion Sport / Cup | 95 - 01 | 1 | ● |
| | 660 | Skorpion Replica | 95 - 01 | 1 | ● |
| | 660 | Skorpion Tour / Traveller | 95 - 02 | 1 | ● |

NORTON

| | | | | | |
|--|-----|--------------------------|---------|---|---|
| | 588 | F-1 (Rotary) P55 Model | 90 | 2 | ● |
| | 588 | F-1 (Rotary) P55 B Model | 90 - 91 | 2 | ● |
| | 588 | TT | 92 - | 2 | ● |

SACHS

| | | | | | |
|-----|-----|---------------|---------|---|---|
| | 125 | X-Road | 06 | 1 | ● |
| | 125 | X-Road | 07 | 1 | ● |
| XTC | 125 | Supersport | 00 - 07 | 1 | ● |
| | 650 | Roadster V1.6 | 01 - 04 | 1 | ● |
| | 650 | Roadster V1.6 | 05 - | 1 | ● |
| | 800 | Roadster V2 | 00 - | 2 | ● |
| | 805 | B / S | 03 - 04 | 2 | ● |

TM

| | | | | | |
|-----|-----|------|---------|---|---|
| SMR | 125 | (2T) | 05 - 10 | 1 | ● |
| SME | 250 | (4T) | 04 | 1 | ● |
| SM | 250 | | 02 | 1 | ● |
| SMM | 250 | (2T) | 05 - 10 | 1 | ● |
| SMR | 250 | (2T) | 05 - 08 | 1 | ● |
| SMM | 300 | (2T) | 05 - 10 | 1 | ● |
| SMR | 300 | (2T) | 05 - 10 | 1 | ● |

| TM | | | | | |
|-------|------------------|---------|---|---|--|
| SME | 400 (4T) | 04 | 1 | ● | |
| SM | 400 | 02 - 03 | 1 | ● | |
| SMR | 450 FES | 05 - 09 | 1 | ● | |
| SM | 530 | 02 - 03 | 1 | ● | |
| SME | 530 (4T) | 04 | 1 | ● | |
| SMR | 530 F ES | 05 - 09 | 1 | ● | |
| SMX | 660 F | 04 | 1 | ● | |
| VOR | | | | | |
| SM | 400 | 00 - 02 | 1 | ● | |
| SM | 450 | 02 | 1 | ● | |
| SM | 500 | 00 - 02 | 1 | ● | |
| SM | 530 | 02 - | 1 | ● | |
| VOXAN | | | | | |
| 1000 | Café-Racer | 02 - 05 | 2 | ● | |
| 1000 | Cyclope | 02 | 2 | ● | |
| 1000 | Roadster | 02 - 05 | 2 | ● | |
| 1000 | Street Scrambler | 03 - 05 | 2 | ● | |

2247 suite

YAMAHA

| | | | | | |
|-----|-----|--------------------------------|---------|---|---|
| TZR | 125 | R (4DL1 / 4DL2) Brembo Caliper | 91 - 93 | 1 | ● |
| TZR | 125 | RR (4DL3) Brembo Caliper | 94 - 95 | 1 | ● |
| SZR | 660 | | 96 - 97 | 1 | ● |

| Street | Sport | Racing | Enduro | MX | Off Road Racing | ATV |
|--------|-------|--------|--------|----|-----------------|-----|
|--------|-------|--------|--------|----|-----------------|-----|

S4 A3+

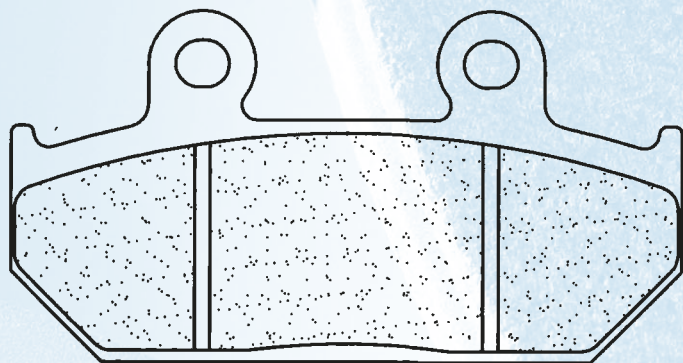

CAGIVA

| 900 | Elefant | | 90 - 92 | 1 | ● |
|-------|----------------------------|--|---------|---|---|
| HONDA | | | | | |
| CB | 125 TT | | 90 | 1 | ● |
| NX | 500 Dominator (Austria) | | 88 - 92 | 1 | ● |
| VT | 600 C Shadow | | 92 | 1 | ● |
| XL | 600 V Transalp | | 91 - 93 | 1 | ● |
| NX | 650 Dominator J / K | | 88 - 92 | 1 | ● |
| XRV | 650 Africa Twin | | 88 - 90 | 1 | ● |
| GL | 1500 Goldwing / SE | | 88 - 93 | 2 | ● |
| GL | 1500 Goldwing Aspencade SE | | 94 - | 2 | ● |
| GLX | 1500 | | 88 - | 2 | ● |

Dim./Size

88 mm

46,1 mm

10 mm

2248

| Street | Sport | Racing | Enduro | MX | Off Road Racing | ATV |
|--------|-------|--------|--------|----|-----------------|-----|
|--------|-------|--------|--------|----|-----------------|-----|

S4 A3+ RX3 XBK5 C59 EN10 MX10 X59

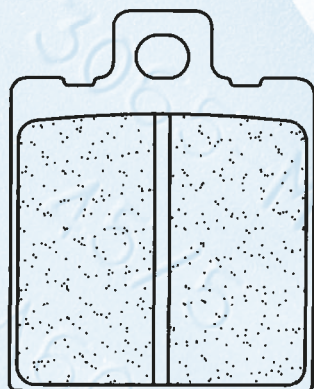

Dim./Size

39,7 mm

50 mm

7 mm

2249

APRILIA

| | | | | | |
|------|-----------------------|--|---------|---|---|
| E.T. | 50 | | 85 - | 1 | ● |
| | 200 Climber | | 93 | 1 | ● |
| MX | 250 Cross | | 85 | 1 | ● |
| RX | 250 | | 86 - | 1 | ● |
| | 125 Classic | | 96 - | | ● |
| | 125 Red Rose | | 89 | | ● |
| | 125 Red Rose | | 90 - | | ● |
| | 125 Sport Prot. | | 92 | | ● |
| | 125 Tuareg | | 87 - | | ● |
| | 125 Tuareg Rally | | 89 | | ● |
| | 125 Tuareg Rally | | 90 - 91 | | ● |
| | 125 Tuono | | 04 - | | ● |
| AF 1 | 125 | | 87 - | | ● |
| AF 1 | 125 Europa / Futura | | 90 - 91 | | ● |
| AF 1 | 125 Replica / Sintesi | | 89 - 91 | | ● |
| ETX | 125 | | 86 - 87 | | ● |
| | 250 Tuareg Rally | | 86 - | | ● |
| RS | 250 | | 95 - 96 | | ● |
| RS | 250 | | 97 - 02 | | ● |
| RS | 250 R Piste | | 04 - | | ● |
| | 350 Tuareg | | 86 - 87 | | ● |
| | 350 Tuareg | | 88 - 89 | | ● |
| | 350 Tuareg Wind | | 87 | | ● |
| | 350 Tuareg Wind | | 88 | | ● |
| ETX | 350 | | - 86 | | ● |
| ETX | 350 | | 86 - | | ● |
| ETX | 600 | | 86 - | | ● |
| | 600 Tuareg | | 86 - 87 | | ● |
| | 600 Tuareg Wind | | 88 | | ● |
| RS | 250 | | 95 - 96 | | ● |
| RS | 250 | | 97 - 02 | | ● |
| RS | 250 R Piste | | 04 - | | ● |

ALFER

| | | | | | |
|----|------------|--|------|---|---|
| MC | 80 | | 87 - | 1 | ● |
| MC | 125 | | 87 | 1 | ● |
| MC | 250 | | 85 | 1 | ● |
| MC | 250 | | 87 | 1 | ● |
| GR | 250 Enduro | | 85 | 1 | ● |
| GR | 300 | | 85 | 1 | ● |
| MC | 125 | | 88 | | ● |
| MC | 250 | | 88 | | ● |
| GR | 250 Enduro | | 88 | | ● |
| GR | 300 Enduro | | 88 | | ● |

| Street | Sport | Racing | Enduro | MX | Off Road Racing | ATV | |
|--------|-------|--------|--------|-----|-----------------|------|-----|
| S4 | A3+ | RX3 | XBK5 | C59 | EN10 | MX10 | X59 |

2249 suite

ARMSTRONG

| | | | | | | | |
|----|-----|--|--|-----|---|---|--|
| MX | 500 | | | 86- | 1 | ● | |
| MX | 600 | | | 86- | 1 | ● | |

ASPES

| | | | | | | | |
|--|-----|---------|--|------|--|--|---|
| | 125 | Sintesi | | 88 - | | | ● |
|--|-----|---------|--|------|--|--|---|

ATK

| | | | | | | | |
|-----|-----|--------------------|--|---------|---|---|---|
| ATK | 350 | GS | | 93 - | 1 | ● | ● |
| ATK | 560 | | | 86 | 1 | ● | |
| ATK | 560 | | | 84 - 85 | 1 | ● | |
| ATK | 560 | | | 87 - 88 | 1 | ● | |
| ATK | 640 | | | 93 - | 1 | ● | ● |
| ATK | 250 | CC / MX | | 91 - 92 | | | ● |
| ATK | 350 | ES / CC / MX / STD | | 91 - 92 | | | ● |
| ATK | 406 | CC / MX | | 91 - 92 | | | ● |
| ATK | 604 | ES / CC / MX / STD | | 91 - 92 | | | ● |

BENELI

| | | | | | | | |
|-----|------|------------|--|---------|---|---|---|
| | 900 | Tornado 3 | | 00 - 02 | | | ● |
| TNT | 1100 | | | 04 | | | ● |
| | 124 | T | | 83 - | 1 | ● | |
| | 125 | 2CE | | 76 - 78 | 1 | ● | |
| | 125 | Custom | | 85 | 1 | ● | |
| | 125 | Sport | | | 1 | ● | |
| | 125 | T | | 76 - | 1 | ● | |
| | 125 | TT | | | 1 | ● | |
| BXK | 125 | | | 88 | 1 | ● | |
| E | 125 | LC | | 85 | 1 | ● | |
| | 250 | 2CE | | | 1 | ● | |
| | 250 | Disc | | 76 - | 1 | ● | |
| | 304 | | | 83 - | 1 | ● | |
| | 350 | 4T Turismo | | | 1 | ● | |
| | 354 | | | 78 - 82 | 2 | ● | |
| | 354 | Sport | | 83 - | 2 | ● | ● |
| | 500 | 4T | | - 76 | 1 | ● | |
| | 500 | -4 | | 76 - | 2 | ● | |
| | 654 | Sport | | 83 | 2 | ● | ● |
| | 125 | Jarno | | 89 | | | ● |
| BX | 125 | | | 89 | | | ● |
| | 900 | Tornado 3 | | 00 - 02 | | | ● |
| TNT | 1100 | | | 04 | | | ● |

BETA

| | | | | | | | |
|-----|-----|---------|--|---------|---|---|---|
| KR | 50 | Twin | | 88 | 1 | ● | ● |
| KR | 50 | | | 86 - 87 | 1 | ● | |
| CR | 250 | | | 83 - | 1 | ● | |
| | 500 | GS / RV | | 84 - | 1 | ● | |
| ALP | 240 | | | 96 - | | | ● |
| ALP | 260 | | | 96 - | | | ● |

BILLET

| | | | | | | | |
|--|--|--------------------------------|--|--|---|---|--|
| | | 6 Piston Caliper - Road/Racing | | | 3 | ● | |
|--|--|--------------------------------|--|--|---|---|--|

BIMOTA

| | | | | | | | |
|-------|------|--------------|--|---------|--|--|---|
| YB7 | 400 | | | 89 | | | ● |
| V Due | 500 | TESI 2 | | 97 - | | | ● |
| | 600 | Bellaria | | 91 - | | | ● |
| YB9 | 600 | SRI | | 96 - | | | ● |
| BB1 | 650 | Supermono | | 96 - | | | ● |
| SB7 | 750 | | | 96 - | | | ● |
| YB4 | 750 | | | 89 | | | ● |
| 1D | 851 | Tesi | | 91 - 95 | | | ● |
| | 900 | Mantra | | 96 - | | | ● |
| DB2 | 900 | | | 92 - | | | ● |
| DB4 | 900 | | | 99 - | | | ● |
| 1D | 904 | Tesi SR / ES | | 96 - | | | ● |
| DB2 | 904 | HF / SR | | 96 - | | | ● |
| 1D | 906 | Tesi | | 91 - 95 | | | ● |
| 2D | 1000 | Tesi | | 04 - 06 | | | ● |
| SB8 | 1000 | R | | 98 - | | | ● |
| SB8K | 1000 | | | 06 - | | | ● |
| SB8K | 1000 | Santamonica | | 07 - | | | ● |
| YB11 | 1000 | | | 97 - | | | ● |
| YB6 | 1000 | | | 89 | | | ● |
| YB8 | 1000 | | | 90 - 95 | | | ● |
| YB11 | 1002 | Dieci | | 91 - 95 | | | ● |
| YB11 | 1002 | Superleggera | | 96 | | | ● |
| DB7 | 1099 | (Rad. Cal) | | 09 - | | | ● |
| SB6 | 1100 | | | 96 - | | | ● |
| SB6 | 1100 | R | | 97 - | | | ● |
| 1D | | Tesi | | 93 - | | | ● |
| DB2 | | | | 92 - | | | ● |
| | | All models | | 89 - 98 | | | ● |
| | | Furano | | 92 - | | | ● |
| YB9 | 600 | SRI | | 96 - | | | ● |
| SB7 | 750 | | | 96 - | | | ● |
| YB4 | 750 | | | 89 | | | ● |
| 1D | 851 | Tesi | | 91 - 95 | | | ● |
| DB2 | 900 | | | 92 - | | | ● |
| DB4 | 900 | | | 99 - | | | ● |
| | 900 | Mantra | | 96 - | | | ● |
| 1D | 904 | Tesi SR / ES | | 96 - | | | ● |
| DB2 | 904 | HF / SR | | 96 - | | | ● |
| 1D | 906 | Tesi | | 91 - 95 | | | ● |

BIMOTA

| | | | | | | | |
|------|------|--------------|--|---------|--|--|---|
| 2D | 1000 | Tesi | | 04 - 06 | | | ● |
| SB8 | 1000 | R | | 98 - | | | ● |
| YB6 | 1000 | | | 89 | | | ● |
| YB8 | 1000 | | | 90 - 95 | | | ● |
| YB11 | 1000 | | | 97 - | | | ● |
| YB11 | 1002 | Dieci | | 91 - 95 | | | ● |
| YB11 | 1002 | Superleggera | | 96 | | | ● |
| DB7 | 1099 | (Rad. Cal) | | 09 - | | | ● |
| SB6 | 1100 | R | | 97 - | | | ● |
| SB6 | 1100 | | | 96 - | | | ● |
| 1D | | Tesi | | 93 - | | | ● |
| DB2 | | | | 92 - | | | ● |
| | | All models | | 89 - 98 | | | ● |
| | | Furano | | 92 - | | | ● |

CAGIVA

| | | | | | | | |
|-----|-----|----------------|--|---------|---|---|---|
| | 50 | Cocis | | 89 | 1 | ● | ● |
| | 50 | Cocis | | 88 - | 1 | ● | |
| | 50 | Lucky Explorer | | 88 - | 1 | ● | |
| | 50 | Prima | | 92 | 1 | ● | ● |
| | 50 | Supercity | | 92 | 1 | ● | ● |
| | 50 | W4 | | 92 | 1 | ● | ● |
| LR | 80 | | | 83 - | 1 | ● | |
| SST | 80 | | | 83 - | 1 | ● | |
| SXT | 80 | | | 83 - | 1 | ● | |
| | 80 | Cocis | | 91 - | 1 | ● | |
| | 80 | Super City | | 92 - 93 | 1 | ● | ● |
| | 80 | W4 | | 92 - | 1 | ● | ● |
| | 125 | Aletta Electra | | 87 - | 1 | ● | |
| | 125 | Aletta Oro | | 86 - | 1 | ● | ● |
| | 125 | Dakar | | 86 | 1 | ● | |
| | 125 | Elefant re | | 87 - | 1 | ● | |
| W8 | 125 | | | 92 - | 1 | ● | ● |
| | 200 | Elefant | | 86 - | 1 | ● | |
| SST | 250 | Ala Verde | | 81 - | 1 | ● | |
| | 350 | Alazurra | | 85 - | 1 | ● | ● |
| SST | 350 | Ala Verde | | 81 - | 1 | ● | |
| SST | 350 | | | 83 - | 1 | ● | |
| SXT | 350 | Ala Rossa | | 82 - | 1 | ● | |
| T4 | 350 | E | | 87 - | 1 | ● | |
| T4 | 350 | R | | 87 - | 1 | ● | |
| MXR | 400 | | | 82 - | 1 | ● | |
| MXR | 500 | | | 82 - | 1 | ● | |
| T4 | 500 | E | | 87 - | 1 | ● | |
| | 650 | Alazurra | | | 1 | ● | ● |
| | 750 | Elefant | | 88 | 1 | ● | ● |
| | 125 | Enduro | | 86 - | 1 | ● | |
| WMX | 125 | GP Replica | | 86 - | 1 | ● | |
| WRX | 125 | | | 83 | 1 | ● | |
| WMX | 250 | GP | | 82 | 1 | ● | |
| MXR | 250 | | | 82 - | 1 | ● | |
| WMX | 500 | Cross | | 87 | 1 | ● | ● |
| WMX | 500 | | | 85 - 86 | 1 | ● | |
| | 50 | Supercity | | 93 - | | | ● |
| | 80 | Super City | | 94 - | | | ● |
| | 125 | Blues | | 92 - 95 | | | ● |
| | 125 | Freccia | | 89 | | | ● |
| | 125 | Freccia C12 R | | 91 - | | | ● |
| | 125 | Mito | | 93 - | | | ● |
| | 125 | Mito EV / SP | | 95 - | | | ● |
| | 125 | Mito Racer | | 91 - 92 | | | ● |
| | 125 | N1 | | 97 - | | | ● |
| | 125 | Planet | | 98 - 02 | | | ● |
| | 125 | Raptor | | 03 - | | | ● |
| | 125 | Supercity | | 92 - 95 | | | ● |
| | 125 | Supercity | | 98 - | | | ● |
| K7 | 125 | | | 91 - | | | ● |
| | 350 | W 12 | | 92 - | | | ● |
| | 350 | Elefant | | 86 - | | | ● |
| | 500 | Mito | | 07 | | | ● |
| | 500 | River | | 00 - | | | ● |
| SP | 525 | Mito | | 08 - | | | ● |
| | 600 | River | | 94 - 95 | | | ● |
| | 650 | Elefant | | 86 - | | | ● |
| | 750 | Lucky Explorer | | 88 | | | ● |
| | 500 | Mito | | 07 | | | ● |
| SP | 525 | Mito | | 08 - | | | ● |

DB MOTORS

| | | | | | | | |
|----|----|-------|--|------|---|---|---|
| ZZ | 50 | Pirat | | 00 - | 1 | ● | ● |
| | 50 | Sport | | 00 - | 1 | ● | ● |

DERBI

| | | | | | | | |
|--|-----|----------|--|----|---|---|---|
| | 250 | RC | | 85 | 1 | ● | |
| | 125 | Mulhacén | | 07 | | | ● |
| | 125 | Terra | | 07 | | | ● |

DUCATI

| | | | | | | | |
|--|-----|------|--|------|---|---|---|
| | 350 | | | 75 - | 1 | ● | |
| | 350 | F3 | | 86 - | 2 | ● | ● |
| | 350 | GTV | | 77 | 1 | ● | ● |
| | 350 | Paso | | 86 - | 2 | ● | ● |

Street Sport Racing Enduro MX Off Road Racing ATV

S4 A3+ RX3 XBK5 C59 EN10 MX10 X59

| Street | Sport | Racing | Enduro | MX | Off Road Racing | ATV |
|----------------|-----------------------|-------------------------|---------|----|-----------------|-----|
| DUCATI | | | | | | |
| 350 | Sport | | 77 - | 2 | ● | ● |
| 500 | GTV | | 77 - | 2 | ● | ● |
| 500 | Sport Desmo | | 77 - | 2 | ● | ● |
| 500 | Twin GTL | | 75 - | 1 | ● | ● |
| 750 | Paso | | 86 | 2 | ● | ● |
| 750 | Paso | | 88 | 2 | ● | ● |
| 350 | Indiana | | 86 - | | ● | ● |
| 400 | Monster (Japan) | | 02 - | | ● | ● |
| 400 | SS Junior | | 92 | | ● | ● |
| 400 | SS Nuda | | 92 - | | ● | ● |
| 500 | Pantah | | 85 - | | ● | ● |
| 502 | Single | | 93 | | ● | ● |
| 502 | Supermono | | 93 | | ● | ● |
| 600 | Monster | | 94 - 99 | | ● | ● |
| 600 | Monster | | 00 - 01 | | ● | ● |
| 600 | Pantah TL / SL | | 81 | | ● | ● |
| 600 | Supersport | | 94 - 95 | | ● | ● |
| 620 | Monster | | 05 - 06 | | ● | ● |
| 620 | Monster Dark | | 06 - | | ● | ● |
| 620 | Monster Dark i.e | | 02 - 05 | | ● | ● |
| 620 | Monster i.e | | 02 - 05 | | ● | ● |
| 620 | Monster si.e | | 02 - 05 | | ● | ● |
| 650 | Indiana | | 86 - | | ● | ● |
| 695 | Monster | | 06 - | | ● | ● |
| 748 | Biposto / SP / Strada | | 95 - 99 | | ● | ● |
| 748 | / S | | 99 - 03 | | ● | ● |
| 748 | R | | 00 | | ● | ● |
| 748 | R | | 01 - 03 | | ● | ● |
| 748 | SPS | | 98 - 99 | | ● | ● |
| 750 | Carenara / Nuda | | 92 - | | ● | ● |
| 750 | Indiana | | 87 - 90 | | ● | ● |
| 750 | Monster | | 96 - 99 | | ● | ● |
| 750 | Monster / Monster i.e | | 00 - 02 | | ● | ● |
| 750 | Paso | | 87 | | ● | ● |
| 750 | Supersport | | 95 - 99 | | ● | ● |
| 800 | Monster i.e / si.e | | 03 - 05 | | ● | ● |
| 800 | Monster S2R | | 05 - 07 | | ● | ● |
| 800 | Monster S2R Dark | | 05 - 06 | | ● | ● |
| 851 | Strada | | 89 | | ● | ● |
| 851 | Superbike | | 90 | | ● | ● |
| 888 | SPO | | 93 | | ● | ● |
| 888 | SPS / SP4 | | 92 - | | ● | ● |
| 888 | SPV | | 92 - 94 | | ● | ● |
| 888 | Strada / Superbike | | 93 | | ● | ● |
| 906 | 900 | Paso | 89 | | ● | ● |
| 907 | 900 | I. E. | 92 | | ● | ● |
| | 900 | Monster iL | 93 - 99 | | ● | ● |
| | 900 | SSR | 92 | | ● | ● |
| | 900 | Superlight | 92 - 95 | | ● | ● |
| | 900 | Supersport | 95 - 97 | | ● | ● |
| | 916 | Biposto | 94 - 97 | | ● | ● |
| | 916 | Monster S4 | 01 - 03 | | ● | ● |
| | 916 | SP / Strada / Senna | 94 - 97 | | ● | ● |
| | 916 | SPS | 97 - 98 | | ● | ● |
| | 996 | Monster S4R | 04 - 05 | | ● | ● |
| | 996 | R | 01 | | ● | ● |
| | 996 | SPS | 99 - 01 | | ● | ● |
| | 998 | / S | 02 - 03 | | ● | ● |
| | 998 | R | 02 | | ● | ● |
| | 1000 | Monster Dark i.e / si.e | 03 - 05 | | ● | ● |
| | 1000 | Monster i.e / si.e | 03 - 05 | | ● | ● |
| | 1000 | Supersport DS | 03 - | | ● | ● |
| | 748 | / S | 99 - 03 | | ● | ● |
| | 748 | Biposto / SP / Strada | 95 - 99 | | ● | ● |
| | 748 | R | 00 | | ● | ● |
| | 748 | R | 01 - 03 | | ● | ● |
| | 748 | SPS | 98 - 99 | | ● | ● |
| | 916 | Biposto | 95 - 97 | | ● | ● |
| | 916 | SP / Strada / Senna | 94 - 97 | | ● | ● |
| | 916 | SPS | 97 - 98 | | ● | ● |
| | 996 | R | 01 | | ● | ● |
| | 996 | SPS | 99 - 01 | | ● | ● |
| | 998 | / S | 02 - 03 | | ● | ● |
| | 998 | R | 02 | | ● | ● |
| FANTIC | | | | | | |
| | 50 | Koala | 88 - | 1 | ● | ● |
| | 125 | Cruiser | 98 - | 1 | ● | ● |
| XM | 50 | Caballero | 98 - | 1 | ● | ● |
| RS | 50 | Caballero | 91 - | 1 | ● | ● |
| RC | 50 | Caballero | 91 - | 1 | ● | ● |
| | 250 | Coach | 91 - | 1 | ● | ● |
| GARELLI | | | | | | |
| | 50 | Tiger XLE | 86 - | 1 | ● | ● |
| | 125 | GTA | 83 - 85 | 2 | ● | ● |
| | | Cyclone LC | 86 | 1 | ● | ● |
| | | Urka | 91 - | 1 | ● | ● |

2249 suite

| Street | Sport | Racing | Enduro | MX | Off Road Racing | ATV |
|------------------|-------|-------------------------------------------------|---------|----|-----------------|-----|
| GILERA | | | | | | |
| RC | 50 | Top Rally | 90 | 1 | ● | ● |
| RI | 50 | | 91 - | 1 | ● | ● |
| RK | 50 | | 96 - | 1 | ● | ● |
| | 50 | Rally | 87 - | 1 | ● | ● |
| | 50 | Sioux | 92 | 1 | ● | ● |
| | 125 | HX / HE | 83 | 1 | ● | ● |
| RX | 125 | Arizona Hawk | 86 - | 1 | ● | ● |
| RX | 125 | | 83 | 1 | ● | ● |
| RX | 200 | | 83 | 1 | ● | ● |
| | 250 | Arizona Hawk | 86 - | 1 | ● | ● |
| | 250 | Arizona Rally | 86 - | 1 | ● | ● |
| SP | | 01 | 90 - | | ● | ● |
| | 125 | Crono | 92 - | | ● | ● |
| | 125 | CX | 91 - | | ● | ● |
| | 125 | Fast Bike | 88 - | | ● | ● |
| | 125 | Freestyle | 92 - | | ● | ● |
| | 125 | KK / KR / KZ | 86 - | | ● | ● |
| | 125 | MX1 / MXR | 89 - | | ● | ● |
| | 125 | R1 / R1S | 90 - | | ● | ● |
| | 125 | SP 01 | 90 | | ● | ● |
| | 125 | SP 02 | 90 - | | ● | ● |
| MXR | 125 | | 90 | | ● | ● |
| XR2 | 125 | | 90 | | ● | ● |
| | 200 | Fast Bike | 87 - | | ● | ● |
| RV | 200 | | 85 - 86 | | ● | ● |
| NGR | 250 | | 85 - | | ● | ● |
| | 350 | Saturno Bialbero | 90 - | | ● | ● |
| XRT | 350 | | 90 - | | ● | ● |
| | 500 | Saturno Bialbero | 90 - | | ● | ● |
| | 500 | Saturno Piuma | 90 - | | ● | ● |
| | 600 | Nordwest | 91 - | | ● | ● |
| RC | 600 | | 88 | | ● | ● |
| XRT | 600 | | 89 | | ● | ● |
| HERCULES | | | | | | |
| ZX | | | 86 - | 1 | ● | ● |
| HONDA | | | | | | |
| CRM | 125 | / R | 90 - 98 | | ● | ● |
| NSR | 125 | F / R | 90 - 92 | | ● | ● |
| NSR | 125 | R (Italy) | 89 - | | ● | ● |
| HUSQVARNA | | | | | | |
| CR | 125 | | 85 - 90 | 1 | ● | ● |
| CX | 125 | | 84 - 85 | 1 | ● | ● |
| CR | 240 | | 84 - 85 | 1 | ● | ● |
| CR | 250 | | 85 - 87 | 1 | ● | ● |
| XC | 250 | | - 85 | 1 | ● | ● |
| WR | 400 | Enduro | 85 - | 1 | ● | ● |
| | 430 | Enduro | 85 - | 1 | ● | ● |
| CR | 500 | | - 85 | 1 | ● | ● |
| CR | 500 | | 86 - | 1 | ● | ● |
| XC | 500 | | - 85 | 1 | ● | ● |
| TC | 500 | | 86 - | 1 | ● | ● |
| | 504 | | 83 - | 1 | ● | ● |
| TE | 510 | | 86 - 87 | 1 | ● | ● |
| ISR | | | | | | |
| | | 2 Piston Caliper (22-027/028/029) - Road/Racing | | 2 | ● | ● |
| ITALJET | | | | | | |
| | 350 | Road master | 83 - | 2 | ● | ● |
| | 900 | Griffon | 00 - | | ● | ● |
| KEEWAY | | | | | | |
| | 125 | Enduro | 07 - | | ● | ● |
| | 125 | X-Ray | 07 - | | ● | ● |
| KTM | | | | | | |
| | | Baja | 86 - | 1 | ● | ● |
| | | Country / Baja | 85 | 1 | ● | ● |
| RSV | 50 | | 86 - | 1 | ● | ● |
| | 80 | PL/RSL/ L/ RS/ RL/ Chopper | 80 - | 1 | ● | ● |
| MX | 50 | | 91 | 1 | ● | ● |
| GXE | 50 | | 87 - | 1 | ● | ● |
| GXE | 50 | | 89 - | 1 | ● | ● |
| GXR | 50 | | 89 - | 1 | ● | ● |
| MX | 50 | | 87 - 91 | 1 | ● | ● |
| MX | 80 | | 86 - 92 | 1 | ● | ● |
| MX | 85 | | 90 | 1 | ● | ● |
| LC | 125 | | 85 | 1 | ● | ● |
| LC | 125 | | 86 - | 1 | ● | ● |
| MX | 125 | | 85 | 1 | ● | ● |
| MX | 125 | | 86 | 1 | ● | ● |
| XC | 125 | | 85 | 1 | ● | ● |
| XC | 125 | | 86 - | 1 | ● | ● |
| | 250 | Baja | 86 - | 1 | ● | ● |
| LC | 250 | | 85 | 1 | ● | ● |
| LC | 250 | | 86 | 1 | ● | ● |
| MC | 250 | | 83 - 84 | 1 | ● | ● |
| MX | 250 | | 83 - 84 | 1 | ● | ● |
| MX | 250 | | 85 | 1 | ● | ● |
| MX | 250 | | 86 | 1 | ● | ● |
| XC | 250 | | 85 | 1 | ● | ● |
| XC | 250 | | 86 - 89 | 1 | ● | ● |

Buyers Guide/Moto

1 - 2 = Nombre de jeux / Number of sets
L = Gauche / Left - R = Droite / Right

| Street | Sport | Racing | Enduro | MX | Off Road Racing | ATV | |
|--------|-------|--------|--------|-----|-----------------|------|-----|
| S4 | A3+ | RX3 | XBK5 | C59 | EN10 | MX10 | X59 |

2249 suite

| | | | | | | |
|-------------------|-----|------------------------|---------|---|---|---|
| KTM | | | | | | |
| XC | 300 | | 85 | 1 | ● | |
| XC | 300 | | 86 - 90 | 1 | ● | ● |
| XC | 350 | /MC | - 83 | 1 | ● | |
| GS | 350 | 500 K4 | - 83 | 1 | ● | |
| | 350 | Country Cross | 85 - | 1 | ● | |
| GS | 350 | | 83 - 86 | 1 | ● | |
| XC | 390 | / MC | - 83 | 1 | ● | |
| GS | 390 | | 83 - | 1 | ● | |
| XC | 420 | / MC | - 83 | 1 | ● | |
| MC | 495 | Leleu | 82 - 83 | 1 | ● | |
| MX | 495 | Leleu | 82 - 83 | 1 | ● | |
| XC | 500 | / MC | - 83 | 1 | ● | |
| GS | 500 | 500K4 Enduro | 83 - | 1 | ● | |
| LC | 500 | | 85 | 1 | ● | |
| LC | 500 | | 86 - | 1 | ● | ● |
| MX | 500 | | 85 | 1 | ● | |
| MX | 500 | | 86 | 1 | ● | ● |
| 4T | 600 | Enduro | 84 - | 1 | ● | |
| GS | 600 | | 85 | 1 | ● | |
| XC | 600 | Cross / XCE Cross | 85 | 1 | ● | |
| | 620 | Duke | 94 - 98 | | | ● |
| LAVERDA | | | | | | |
| | 50 | GaUCHO | 92 | 1 | ● | ● |
| OR | 50 | Atlas | 86 | 1 | ● | ● |
| OR | 50 | Atlas | 90 - | 1 | ● | ● |
| CU | 125 | Ride | 86 - | 1 | ● | |
| LB | 125 | Uno | 85 - | 1 | ● | |
| | 125 | Custom | 86 - | 1 | ● | |
| GS | 350 | Lesmo | 86 - | 2 | ● | ● |
| PF | 350 | Alpino | | 2 | ● | ● |
| RS | 350 | Alpino | | 2 | ● | ● |
| | 500 | Alpino / S | 77 - | 2 | ● | ● |
| OR | 600 | Atlas | 86 - | | | ● |
| | 650 | Ghost | 96 - | | | ● |
| | 650 | Ghost Legend | 97 - | | | ● |
| | 650 | Sport | 92 - | | | ● |
| | 650 | Strike | 97 - | | | ● |
| | 668 | Diamante | 97 - | | | ● |
| | 668 | Ghost Strike | 98 - | | | ● |
| | 668 | | 96 - | | | ● |
| | 750 | Cup | 98 - | | | ● |
| | 750 | Diamante | 97 - | | | ● |
| | 750 | Ghost Strike | 97 - | | | ● |
| | 750 | S / S Formula / Strike | 97 - | | | ● |
| | 750 | S SPORT | 99 - | | | ● |
| MAICO | | | | | | |
| GM | 250 | LC | 85 - | 1 | ● | |
| MD | 250 | | 83 - | 1 | ● | ● |
| GM | 500 | LC | 85 - | 1 | ● | |
| MALAGUTI | | | | | | |
| MRX | 50 | Enduro | 85 - | 1 | ● | |
| MONTESA | | | | | | |
| | 260 | Evasion | 92 | | | ● |
| | 309 | Cota | 89 - | | | ● |
| | 310 | Cota | 89 - | | | ● |
| | 311 | Cota Trial | 92 | | | ● |
| MOTO GUZZI | | | | | | |
| | 125 | BX | 92 | 1 | ● | ● |
| | 125 | Custom | 85 | 1 | ● | |
| | 125 | Enduro TT | 85 | 1 | ● | |
| | 240 | / 4 | 77 - | 1 | ● | |
| | 250 | TS | 75 - 76 | 1 | ● | |
| | 350 | | 77 - | 2 | ● | ● |
| | 350 | Falco | 88 | 1 | ● | ● |
| | 350 | Imola | 78 - | 2 | ● | ● |
| | 350 | Nevada | 92 - | 2 | ● | ● |
| NTX | 350 | | 88 | 1 | ● | ● |
| NTX | 350 | | 90 - | 1 | ● | |
| V35 | 350 | GT | | 1 | ● | |
| V35 | 350 | II / Imola / Imola II | 77 | 2 | ● | ● |
| | 400 | | 79 - | 2 | ● | ● |
| | 500 | | 77 - | 2 | ● | ● |
| V50 | 500 | 1/2/3/ Monza / Chopper | 77 | 2 | ● | ● |
| | 500 | Monza | 78 - | 2 | ● | ● |
| | 650 | | 80 - | 2 | ● | ● |
| GT | 650 | Sessantacinque | 89 | 2 | ● | ● |
| NTX | 650 | | 90 - | 1 | ● | |
| V65 | 650 | Lario | 86 - | 2 | ● | ● |
| V65 | 650 | NTX | 87 - | 1 | ● | ● |
| V65 | 650 | SP / Chopper | | 2 | ● | ● |
| V65 | 650 | TT | 86 - | 2 | ● | ● |
| | 750 | Nevada | 91 - 92 | 2 | ● | ● |
| | 750 | Nevada Club | 98 - 01 | 2 | ● | |
| | 750 | Targa | 89 | 2 | ● | ● |
| NTX | 750 | | 89 | 1 | ● | ● |
| V35 | 350 | C | | | | ● |
| V35 | 350 | Florida | | | | ● |

| | | | | | | |
|--------------------|------|---------------------------------------|---------|---|---|---|
| MOTO GUZZI | | | | | | |
| V35 | 350 | GT | 90 - | | | ● |
| V7 | 750 | Ippogrifo | 97 - | | | ● |
| RS | 1000 | Daytona | 97 - | | | ● |
| | 1000 | Quota | 92 - 97 | | | ● |
| V10 | | Centaur | 97 - 99 | | | ● |
| | 1100 | California EV (Single pin pad fixing) | 97 - 00 | | | ● |
| | 1100 | Sport | 94 - 99 | | | ● |
| | 1100 | Sport Corsa | 98 - 99 | | | ● |
| V11 | 1100 | Lemans (All Models) | 01 - 04 | | | ● |
| V11 | 1100 | Scura / Sport Scura | 02 - | | | ● |
| V11 | 1100 | Sport | 97 - 00 | | | ● |
| V11 | 1100 | Sport (All Models) | 01 - | | | ● |
| MOTO MORINI | | | | | | |
| | 400 | S | | 2 | ● | ● |
| RLX | 350 | Excalibur | 90 - | | | ● |
| | 350 | Coguardo / New York | 90 - | | | ● |
| | 350 | Dart | 88 | | | ● |
| | 350 | Indiana | 88 | | | ● |
| | 350 | Kanguro | 87 | | | ● |
| | 400 | Dart | 89 | | | ● |
| | 501 | Camel | 88 | | | ● |
| | 501 | Coguardo | 89 | | | ● |
| | 501 | Excalibur | 89 | | | ● |
| RLX | 501 | Excalibur | 90 - | | | ● |
| | 501 | New York | 89 | | | ● |
| | 650 | Indiana | 88 | | | ● |
| | 750 | Indiana | 88 | | | ● |
| MZ / MUZ | | | | | | |
| | 660 | Mastiff 17" | 99 - 05 | | | ● |
| | 660 | Skorpion Sport / Cup | 95 - 01 | | | ● |
| | 660 | Skorpion Replica | 95 - 01 | | | ● |
| | 660 | Skorpion Tour / Traveller | 95 - 02 | | | ● |
| NORTON | | | | | | |
| | 588 | F-1 (Rotary) P55 Model | 90 | | | ● |
| SANGLAS | | | | | | |
| | 400 | Y | 79 - 80 | 2 | ● | ● |
| | 500 | S2 | 79 - 80 | 2 | ● | ● |
| SIMSON | | | | | | |
| SR | 80 | 2 CE | | 1 | ● | ● |
| | 80 | IFA | 89 | 1 | ● | |
| S | 83 | CX | | 1 | ● | |
| S | 83 | OR | | 1 | ● | |
| SWM | | | | | | |
| | 125 | GP | 86 - | 1 | ● | ● |
| | 125 | S1 - S2 | | 1 | ● | |
| | 250 | S1 - S2 | | 1 | ● | |
| | 250 | Explorer | 86 | 1 | ● | ● |
| | 250 | Pioner | 86 | 1 | ● | ● |
| TRL | 329 | MJ | 86 - | 1 | ● | ● |
| TM | | | | | | |
| SMM | 125 | Black Dream (Rim brake) | 04 - 07 | | | ● |
| SMM | 125 | Black Dream (2T) | 08 - 10 | | | ● |
| SMM | 250 | (2T) | 05 - 10 | | | ● |
| SMM | 300 | (2T) | 05 - 10 | | | ● |
| SMM | 400 | (4T) (Rim brake) | 04 | | | ● |
| SMM | 450 | F Black Dream ES | 08 - 10 | | | ● |
| SMM | 530 | F Black Dream (Rim brake) | 04 - 07 | | | ● |
| SMM | 530 | F Black Dream ES | 08 - 10 | | | ● |
| VOXAN | | | | | | |
| | 1000 | Charade Racing | 06 | | | ● |
| YAMAHA | | | | | | |
| TDR | 125 | R (SSH2/3XE2) Lightburner | 93 - 94 | | | ● |
| TZR | 125 | R (4DL1 / 4DL2) Brembo Caliper | 91 - 93 | | | ● |
| TZR | 125 | RR (4DL3) Brembo Caliper | 94 - 95 | | | ● |
| SZR | 660 | | 96 - 97 | | | ● |

Street Sport Racing Enduro MX Off Road Racing ATV

S4 A3+ XBK5 C59

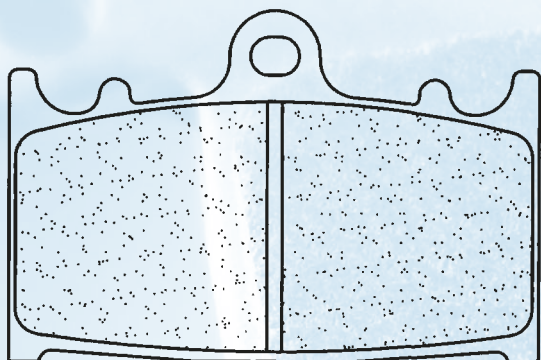

Dim./Size
69,7 mm
46,3 mm
8 mm

2251

BERINGER

4 Piston Caliper - Road/Racing 1 ●

HUSABERG

| | | | | | |
|----|-----|----------|---------|---|---|
| FS | 400 | e / c SM | 01 - 03 | 1 | ● |
| FS | 450 | e / c SM | 04 - | 1 | ● |
| FS | 650 | e / c SM | 01 - | 1 | ● |

KAWASAKI

| | | | | | |
|-------|-----|---------------|---------|---|---|
| KR1 | 250 | S | 90 | 2 | ● |
| ZX-4 | 400 | | 90 | 2 | ● |
| ZXR | 400 | | 89 - 90 | 2 | ● |
| ZZR | 400 | | 90 - 94 | 2 | ● |
| GPZ | 500 | | 93 - 95 | 1 | ● |
| ZZR | 500 | (Austria) | 90 - 92 | 2 | ● |
| ZZR | 500 | (Austria) | 93 - | 2 | ● |
| EN | 600 | R Ninja | 89 - | 2 | ● |
| ZX6-R | 600 | D1-D4 | 90 - 93 | 2 | ● |
| ZX6-R | 600 | E1-E5 Ninja | 93 - 97 | 2 | ● |
| ZX6-R | 600 | Ninja F1 / F2 | 95 - 97 | 2 | ● |
| ZZR | 600 | | 90 - 92 | 2 | ● |
| ZZR | 600 | | 93 - 95 | 2 | ● |
| ZX7-R | 750 | Ninja | 89 - 95 | 2 | ● |
| ZXR | 750 | R | 89 - 92 | 2 | ● |
| ZXR | 750 | R | 93 - 95 | 2 | ● |

KAWASAKI

| | | | | | |
|-------|------|-------------|---------|---|---|
| GPZ | 900 | R | 90 - | 2 | ● |
| ZX9-R | 900 | Ninja | 94 - 95 | 2 | ● |
| ZR | 1100 | Zephyr | 92 - 96 | 2 | ● |
| ZX | 1100 | D1-D4 ZX 11 | 93 - 97 | 2 | ● |
| ZZR | 1100 | | 90 - 93 | 2 | ● |
| ZZR | 1100 | | 94 - 01 | 2 | ● |
| ZZR | 1200 | | 02 - | 2 | ● |
| VN | 1700 | Voyager | 09 - | 2 | ● |
| VN | 2000 | / Vulcan | 04 - | 2 | ● |

SUZUKI

| | | | | | |
|-------|------|--------------------------------|---------|---|---|
| RG | 125 | F Gamma | 92 - 96 | 1 | ● |
| RG | 200 | Gamma | 91 - | 1 | ● |
| GSX | 250 | S Cobra | 89 - | 1 | ● |
| GSX-R | 250 | R | 89 - | 2 | ● |
| RGV | 250 | Gamma J | 88 | 2 | ● |
| RGV | 250 | Gamma K / L | 89 - 90 | 2 | ● |
| RGV | 250 | Gamma M / N / P / R / S | 91 - 95 | 2 | ● |
| TV | 250 | J / K / AK / L / Wolf | 88 - 90 | 1 | ● |
| SG | 350 | N Goose | 92 - | 1 | ● |
| GSF | 400 | Bandit (GK75A) K/NK/Z/VM/ZM/P | 89 - 94 | 2 | ● |
| GSF | 400 | Bandit (GK7AA) S/VS/V-VZ-V | 95 - 97 | 2 | ● |
| GSR | 400 | K6 | 06 - | 2 | ● |
| GSX | 400 | SSN Katana (GK77A) | 92 - | 2 | ● |
| GSX-R | 400 | J/RR/RAK (GK73A) | 88 - 90 | 2 | ● |
| GSR | 600 | K6 / K7 / K8 | 06 - | 2 | ● |
| GSX-R | 600 | VW/X/Y/K1/K2/K3 | 97 - 03 | 2 | ● |
| GSF | 650 | Bandit / Bandit S | 07 - | 2 | ● |
| GSF | 650 | Bandit ABS / Bandit S ABS | 07 - | 2 | ● |
| GSX | 650 | F | 08 - | 2 | ● |
| GSX-R | 750 | Y / K1 / K2 / K3 | 00 - 03 | 2 | ● |
| SV | 1000 | S / N K3 -K7 | 03 - 07 | 2 | ● |
| TL | 1000 | S | 97 - 01 | 2 | ● |
| GSF | 1200 | S / N Bandit K6 | 06 | 2 | ● |
| GSF | 1200 | S / N Bandit ABS K6 | 06 | 2 | ● |
| GSF | 1250 | S / N Bandit (K7/K8/K9/L0) | 07 - 10 | 2 | ● |
| GSF | 1250 | S / N Bandit ABS (K7/K8/K9/L0) | 07 - 10 | 2 | ● |
| GSF | 1250 | FA Traveller | 10 - | 2 | ● |

Street Sport Racing Enduro MX Off Road Racing ATV

S4 A3+ RX3 XBK5 C59

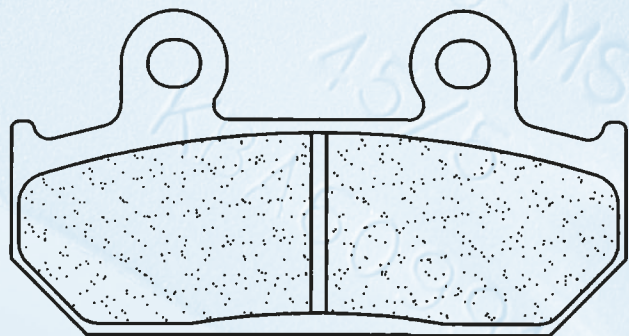

Dim./Size
81 mm
42,2 mm
8,5 mm

2252

HONDA

| | | | | | |
|-----|-----|------------------|---------|---|---|
| CBR | 250 | F | 86 - | 2 | ● |
| CBR | 250 | Hurricane | 87 - | 2 | ● |
| NSR | 250 | R | 87 - | 2 | ● |
| VT | 250 | F | 88 - 90 | 1 | ● |
| VTR | 250 | | 90 | 1 | ● |
| VTZ | 250 | | 88 - | 1 | ● |
| CB | 350 | S. G. | 87 - 90 | 2 | ● |
| NX | 350 | | 92 - | 1 | ● |
| CB | 400 | N | 86 - | 1 | ● |
| CBR | 400 | R | 87 | 2 | ● |
| CBR | 400 | F | 92 - | 2 | ● |
| VFR | 400 | R NC21 / NC21 Z | 86 - | 2 | ● |
| VFR | 400 | R NC24 | 87 - | 2 | ● |
| CB | 450 | S | 86 - | 2 | ● |
| CBR | 500 | F (Austria) | 87 - 90 | 2 | ● |
| CBR | 600 | F / F Supersport | 91 - 94 | 2 | ● |
| CBR | 600 | F Hurricane | 87 - 90 | 2 | ● |
| NTV | 600 | Révéré | 88 - | 1 | ● |
| VT | 600 | C Shadow | 89 - 91 | 1 | ● |
| XRV | 750 | Africa Twin | 90 - 92 | 1 | ● |

Street Sport Racing Enduro MX Off Road Racing ATV

A3+

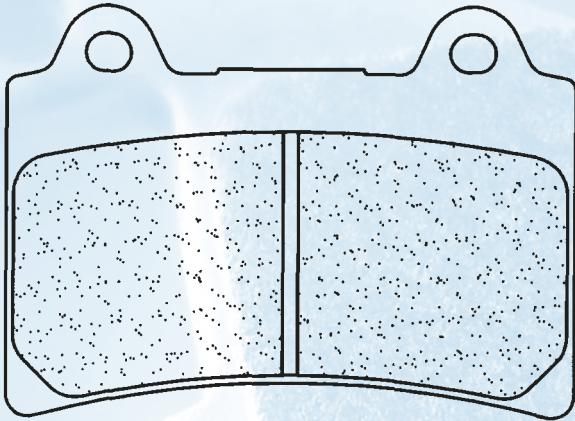

2253

YAMAHA

| | | | | | |
|-----|------|-----------------------------|---------|---|---|
| XVZ | 1300 | A Royal Star / Tour Classic | 96 - 01 | 2 | ● |
| XVZ | 1300 | Venture Royale | 86 - 89 | 2 | ● |
| XVZ | 1300 | Venture Royale | 90 - 95 | 2 | ● |

Dim./Size

→ 74,9 mm
↑ 54 mm
H 8,5 mm

Street Sport Racing Enduro MX Off Road Racing ATV

A3+ XBK5

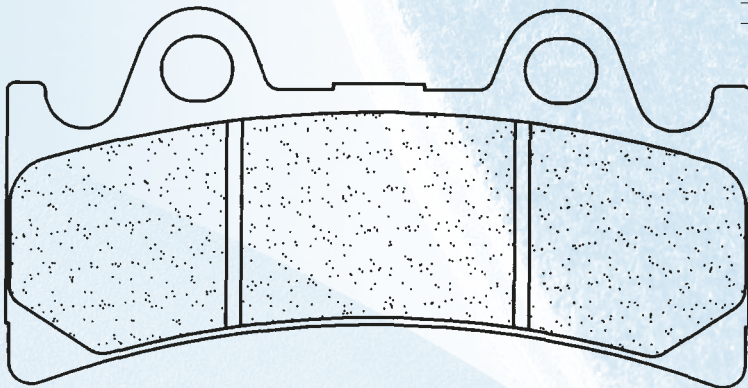

2254

TRIUMPH

| | | | | |
|-----|-------------------|---------|---|---|
| 900 | Daytona Super III | 94 - 97 | 2 | ● |
|-----|-------------------|---------|---|---|

YAMAHA

| | | | | | |
|-----|------|--------|---------|---|---|
| YZF | 750 | R / SP | 93 - 97 | 2 | ● |
| FZR | 1000 | EXUP | 94 - 95 | 2 | ● |

Dim./Size

→ 98,7 mm
↑ 49,6 mm
H 9,5 mm

Street Sport Racing Enduro MX Off Road Racing ATV

A3+ XBK5 C59

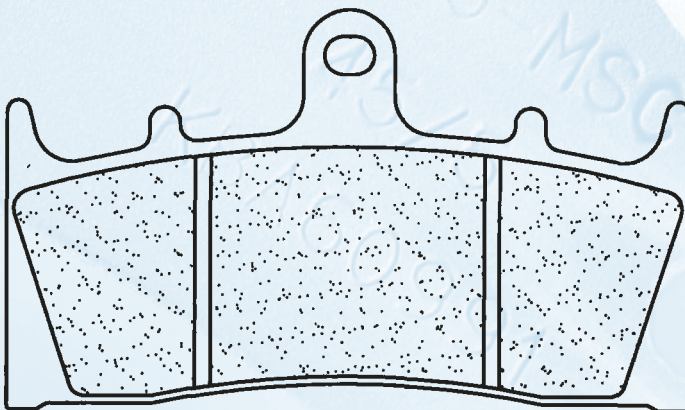

2255

KAWASAKI

| | | | | | |
|--------|------|-----------------|---------|---|---|
| ZX6-R | 600 | Ninja (ZX600G) | 98 - 02 | 2 | ● |
| ZX6-R | 636 | Ninja | 02 | 2 | ● |
| ZX7-R | 750 | Ninja | 96 - 02 | 2 | ● |
| ZX9-R | 900 | Ninja / C Ninja | 96 - 01 | 2 | ● |
| ZRX | 1100 | | 96 - 00 | 2 | ● |
| ZRX | 1200 | / S / R | 01 - 08 | 2 | ● |
| ZX12-R | 1200 | Ninja | 00 - 03 | 2 | ● |
| VN | 1500 | Mean Streak | 02 - 03 | 2 | ● |
| VN | 1600 | Mean Streak | 04 | 2 | ● |

SUZUKI

| | | | | | |
|-------|------|---------------------------|---------|---|---|
| GSX-R | 750 | WR / WS | 94 - 95 | 2 | ● |
| GSX-R | 750 | T / V / W / X | 96 - 99 | 2 | ● |
| GSX-R | 1000 | K1 / K2 | 01 - 02 | 2 | ● |
| TL | 1000 | R | 98 - 02 | 2 | ● |
| GSX-R | 1100 | WP / WR / WS / WT (GV75A) | 93 - 97 | 2 | ● |
| GS | 1200 | SS (GV78A) | 01 | 2 | ● |
| GSF | 1200 | S / N Bandit K1-K5 | 01 - 05 | 2 | ● |
| GSX-R | 1300 | Hayabusa | 99 - 07 | 2 | ● |
| GSX | 1400 | | 01 - 07 | 2 | ● |
| VZ | 1600 | Marauder | 04 | 2 | ● |

Dim./Size

→ 89,5 mm
↑ 52,4 mm
H 8 mm

Street Sport Racing Enduro MX Off Road Racing ATV

S4 A3+ XBK5 C59

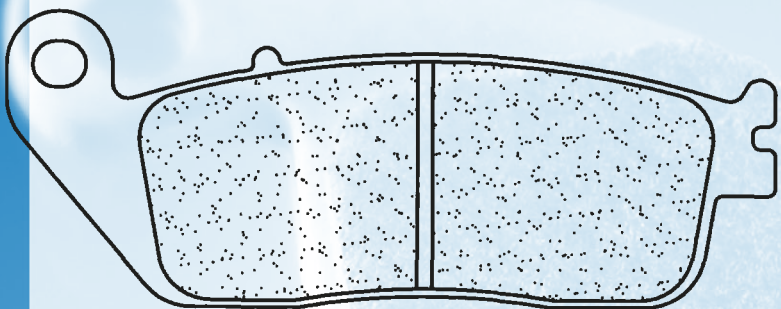

2256

Dim./Size

102 mm

40 mm

8,1 mm

| | | | | |
|---------------|------------------|---------|---|---|
| BUELL | | | | |
| 500 | Blast | 01 - | 1 | ● |
| CAGIVA | | | | |
| 900 | Gran Canyon | 99 - | 2 | ● |
| 1000 | Navigator | 00 - | 2 | ● |
| HONDA | | | | |
| RS 125 | R | 91 - 94 | 1 | ● |
| XLR 125 | R | 98 - | 1 | ● |
| CB 250 | | 92 - 05 | 1 | ● |
| CBR 250 | Nighthawk | 92 - | 1 | ● |
| CBR 250 | R / RR | 90 - | 2 | ● |
| CBR 250 | RJ | 88 - | 2 | ● |
| VT 250 | Spada | 89 - | 1 | ● |
| 250 | Steed | 93 - | 1 | ● |
| CB-1 400 | (CB 400 F) | 89 - 90 | 1 | ● |
| CBR 400 | RR | 87 - | 2 | ● |
| CBR 400 | R | 88 - 93 | 2 | ● |
| NV 400 | Steed | 92 - 93 | 1 | ● |
| CB 500 | | 94 - 96 | 1 | ● |
| CBF 500 | | 04 - | 1 | ● |
| 600 | Steed | 92 - | 1 | ● |
| CB 600 | F Hornet | 98 - 06 | 2 | ● |
| CB 600 | F Hornet S | 00 - | 2 | ● |
| CB 600 | Hornet | 07 - | 2 | ● |
| CB 600 | Hornet Wakizashi | 06 - | 2 | ● |
| CBF 600 | N / S - ABS | 04 - 07 | 2 | ● |
| CBR 600 | F 3 | 95 - 98 | 2 | ● |

| | | | | |
|-----------------|-----------------------------------|---------|---|---|
| HONDA | | | | |
| VT 600 | C Shadow | 93 - | 1 | ● |
| VT 600 | CD Shadow VLX | 94 - | 2 | ● |
| FMX 650 | | 05 - | 1 | ● |
| NT 650 | Hawk GT | 88 - 91 | 1 | ● |
| NTV 650 | Revere | 88 - 93 | 1 | ● |
| VFR 700 | F Interceptor | 88 - 89 | 2 | ● |
| CB 750 | N / F Seven Fifty | 92 - | 2 | ● |
| CB 750 | Nighthawk | 91 - | 2 | ● |
| VFR 750 | F | 88 - 89 | 2 | ● |
| VFR 750 | F | 90 - 98 | 2 | ● |
| PC 800 | Pacific Coast | 89 - 97 | 2 | ● |
| VFR 950 | F / Carat | 92 - | 2 | ● |
| CBF 1000 | | 06 - | 2 | ● |
| CBF 1000 | Limited Edition | 09 - | 2 | ● |
| CBR 1000 | F | 89 - 92 | 2 | ● |
| VFR 1000 | | 89 - | 2 | ● |
| ST 1100 | Pan European | 90 - 02 | 2 | ● |
| ST 1100 | Pan European ABS-TCS | 92 - 95 | 2 | ● |
| VT 1100 | C Shadow | 94 - 96 | 2 | ● |
| VT 1100 | C2 Shadow | 95 - | 2 | ● |
| VT 1100 | C3 Shadow | 98 - | 1 | ● |
| VT 1100 | T Shadow | 98 - | 1 | ● |
| VTX 1300 | C / S | 03 - | 1 | ● |
| GL 1500 | F6C Custom / C Valkyrie | 96 - 02 | 2 | ● |
| HYOSUNG | | | | |
| 125 | V2 | 99 - | 1 | ● |
| KAWASAKI | | | | |
| Z 750 | / ABS | 07 - | 2 | ● |
| KYMC0 | | | | |
| 250 | Venox | 00 - 10 | 1 | ● |
| SUZUKI | | | | |
| GSX 400 | R/S/T/ZR/ZS/ZT (GK79A) Impulse S | 94 - 96 | 2 | ● |
| RF 400 | RP/RR/VR/RT/RVT/RV-V (GK78A) | 93 - 97 | 2 | ● |
| GSF 600 | S / N Bandit | 95 - 99 | 2 | ● |
| RF 600 | R (GN67A) | 93 - 97 | 2 | ● |
| TRIUMPH | | | | |
| 675 | Street Triple | 07 - | 2 | ● |
| 800 | America | 03 - 06 | 1 | ● |
| 800 | Bonneville | 01 - 04 | 1 | ● |
| 800 | Bonneville / America / T100 | 02 - | 1 | ● |
| 800 | Speedmaster | 03 - 04 | 2 | ● |
| 900 | Adventurer | 96 - | 1 | ● |
| 900 | America | 07 - | 1 | ● |
| 900 | Bonneville / T100 | 05 - 08 | 1 | ● |
| 900 | Bonneville / Bonneville SE / T100 | 09 - | 1 | ● |
| 900 | Legend TT | 98 - 01 | 2 | ● |
| 900 | Scrambler | 06 - | 1 | ● |
| 900 | Speedmaster | 05 - | 2 | ● |
| 900 | Thrupton | 04 - | 1 | ● |
| 900 | Thunderbird | 95 - 03 | 1 | ● |
| 900 | Thunderbird Sport | 98 - 04 | 2 | ● |
| 900 | Tiger | 99 - 00 | 2 | ● |
| 955 | Tiger (Up to VIN 198874) | 00 - 04 | 2 | ● |
| 955 | Tiger (From VIN 198875) | 04 - 06 | 2 | ● |
| VOXAN | | | | |
| 1000 | Scrambler | 06 - | 2 | ● |
| YAMAHA | | | | |
| WR 125 | R | 09 - | 1 | ● |
| WR 125 | X Supermotard | 09 - | 1 | ● |
| WR 250 | X Supermotard | 08 - | 1 | ● |

Street Sport Racing Enduro MX Off Road Racing ATV

A3+ RX3

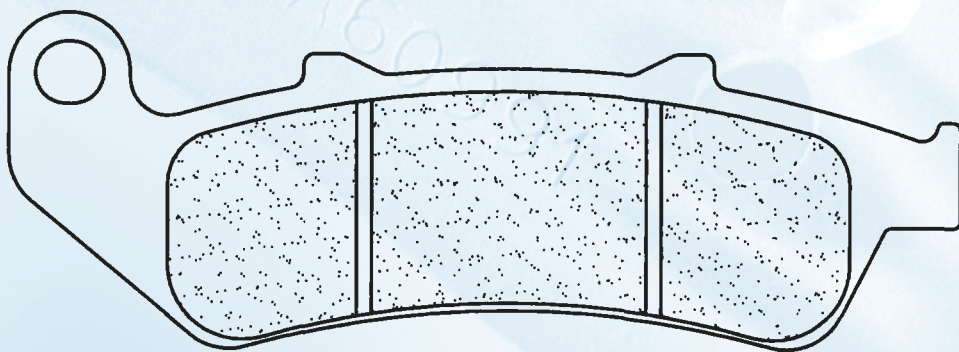

2257

Dim./Size

125,4 mm

45,8 mm

8,5 mm

| | | | | |
|--------------|--------------------|---------|---|---|
| HONDA | | | | |
| CBR 1000 | F / FP ABS-TCS-CBS | 93 - 99 | 2 | ● |

Street Sport Racing Enduro MX Off Road Racing ATV

A3+

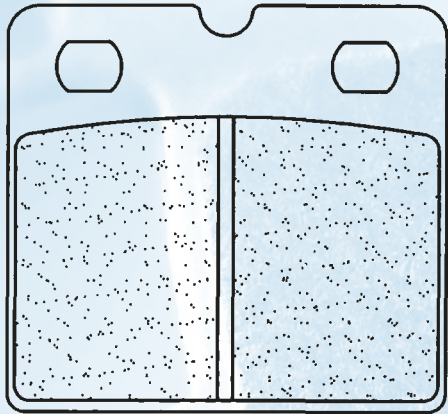

Dim./Size

→ 57,6 mm
↑ 53,3 mm
H 8 mm

2258

| Model | Year | Quantity | Availability |
|----------|--------------|------------|--------------|
| BMW K75 | 750 | 09/88 - | 1 ● |
| BMW K75 | 750 RT (ABS) | 91 - | 2 ● |
| BMW K75 | 750 S | 09/88 - | 1 ● |
| BMW R80 | 800 GS | 85 - 08/88 | 1 ● |
| BMW R80 | 800 RT | 08/89 - | 1 ● |
| BMW R80 | 800 | 85 - 08/88 | 1 ● |
| BMW K100 | 1000 LT / RS | 09/88 - 90 | 2 ● |
| BMW K100 | 1000 LT ABS | 89 | 2 ● |
| BMW R100 | 1000 RS | 08/89 - | 1 ● |
| BMW R100 | 1000 RT | 08/89 - 91 | 1 ● |

Street Sport Racing Enduro MX Off Road Racing ATV

S4

EN10

X59

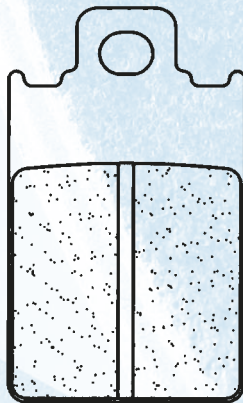

Dim./Size

→ 31,6 mm
↑ 52 mm
H 5,5 mm

2260

| Brand | Model | Year | Quantity | Availability |
|----------|--------------------|---------|----------|--------------|
| APRILIA | 125 Tuareg Wind | 88 | 1 ● | |
| APRILIA | 240 Climber | 89 - 90 | 1 ● | |
| APRILIA | 275 Climber | 89 - 90 | 1 ● | |
| ATK | 560 | 89 - 91 | ● | |
| ATK | 604 Quadracer | 90 - | ● | |
| ATK | 604 | 91 - | ● | |
| BETA | MX 50 Enduro | 92 | 1 ● | |
| BETA | ALP 50 | 91 - | ● | |
| BETA | TR 125 34 | 88 | ● | |
| BETA | TR 260 34 | 86 - 88 | ● | |
| CAGIVA | 50 Prima | 93 - | ● | |
| CAGIVA | 80 Prima | 92 - | ● | |
| DERBI | 75 GPR | 89 | 1 ● | |
| DERBI | 75 GPR Sport | | 1 ● | |
| FANTIC | 50 Oasis | 90 - | ● | |
| FANTIC | 75 Oasis | 89 - | ● | |
| GARELLI | 50 Sahel | 91 - | 1 ● | |
| MALAGUTI | MDX 50 Gold Enduro | 87 - | ● | |
| MALAGUTI | MLX 50 Enduro | 87 - | ● | |

Street Sport Racing Enduro MX Off Road Racing ATV

RX3

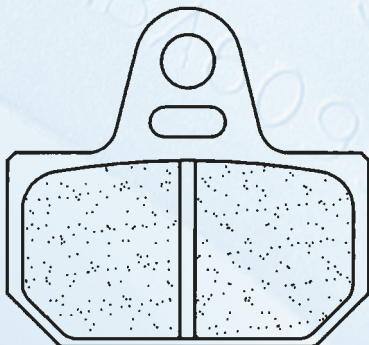

Dim./Size

→ 47,5 mm
↑ 44,5 mm
H 7 mm

2269

| Brand | Model | Year | Quantity | Availability |
|--------|-------------------|---------|----------|--------------|
| YAMAHA | TZ 125 | 97 - | ● | |
| YAMAHA | TZ 250 GP / A / D | 90 - 95 | ● | |
| YAMAHA | TZ 250 | 97 - | ● | |

Street Sport Racing Enduro MX Off Road Racing ATV

A3+ RX3

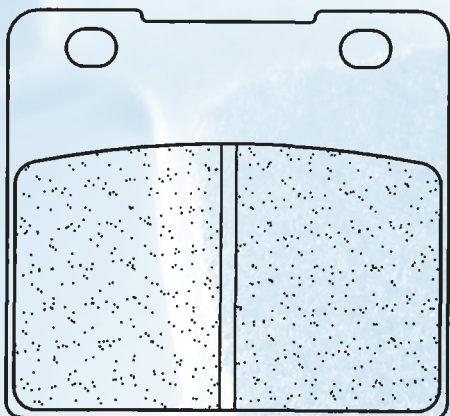

2280

Dim./Size
 — 57,9 mm
 ↑ 53,5 mm
 H 8,5 mm

KAWASAKI

| | | | | | |
|---------------|------|--------------------------------|---------|---|---|
| Z | 1100 | ST | 81 | - | ● |
| SUZUKI | | | | | |
| GSX | 250 | RCH / H (GJ72A) | 87 | 2 | ● |
| GSX-R | 250 | | 88 - 89 | 2 | ● |
| GSX | 400 | X/XA/XS Impulse | 86 | 2 | ● |
| GSX-R | 400 | R3 (GK71F) | 83 | 2 | ● |
| GSX-R | 400 | H | 87 | 2 | ● |
| RG | 400 | Type 1 & 2 | 85 - 87 | 2 | ● |
| VS | 400 | Intruder | 94 | 1 | ● |
| RG | 500 | CH / R Gamma | 85 - 87 | 2 | ● |
| VS | 600 | GL Intruder | 95 - 97 | 1 | ● |
| GSX | 650 | GT | 86 | | ● |
| VS | 700 | GLFG Intruder | 86 - 87 | 1 | ● |
| GSX | 750 | SE Katana | 85 | | ● |
| GSX-R | 750 | F / G / H | 85 - 87 | 2 | ● |
| VS | 750 | GLF/GLFG/GLPP Intruder (VR51A) | 85 - 91 | 2 | ● |
| VS | 800 | Intruder GLN-GLX (VS52A) | 91 - 99 | 1 | ● |
| GSX | 1100 | EFE / EFF / ESE | 84 - 86 | 2 | ● |
| GSX | 1100 | FJ/FK/FL/FM/FN/FP/FR (GV72A) | 88 - 95 | | ● |
| GSX-R | 1100 | G / H / J (GV74B) | 86 - 88 | 2 | ● |
| GS | 1150 | EG | 86 | 2 | ● |
| GS | 1150 | ES | 84 | 2 | ● |
| GV | 1400 | Cavalcade (Up to F/No 103764) | 86 | 2 | ● |
| VS | 1400 | GL Intruder (VX51L) | 87 - 04 | 2 | ● |
| VL | 1500 | Intruder Legendary Classic | 98 - 01 | 1 | ● |

Street Sport Racing Enduro MX Off Road Racing ATV

A3+ RX3

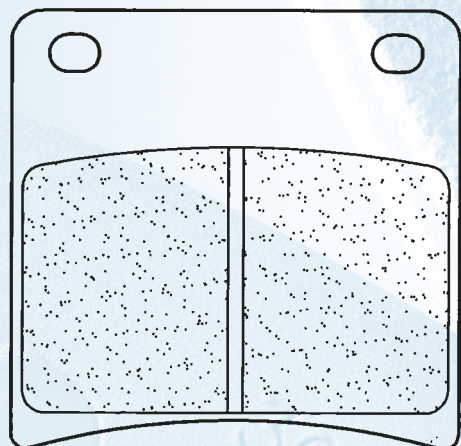

Dim./Size
 — 58,9 mm
 ↑ 57,7 mm
 H 8 mm

2281

SUZUKI

| | | | | | |
|-------|------|---------------------------------|---------|---|---|
| GSX | 400 | FJ/FK/FAK/FL (GK74A) | 88 - 90 | 2 | ● |
| GSX-F | 600 | FJ (GN72A) | 88 | 2 | ● |
| GSX-F | 600 | FK/FL/FM/FN/FP/FR/FS/FT/(GN72A) | 89 - 97 | 2 | ● |
| GSX-F | 750 | FK/FL/FM/FN/FP/FR/FS/FT/(GR78A) | 89 - 97 | 2 | ● |
| VX | 800 | L / M / N / P / R | 90 - 96 | | ● |
| GSX | 1100 | FJ/FK/FL/FM/FN/FP/FR (GV72A) | 88 - 95 | 2 | ● |
| GSX | 1100 | GM / GN / GP | 91 - 93 | | ● |
| GV | 1400 | Cavalcade (From F/No 103765) | 86 - 88 | 2 | ● |

Street Sport Racing Enduro MX Off Road Racing ATV

S4 A3+ RX3

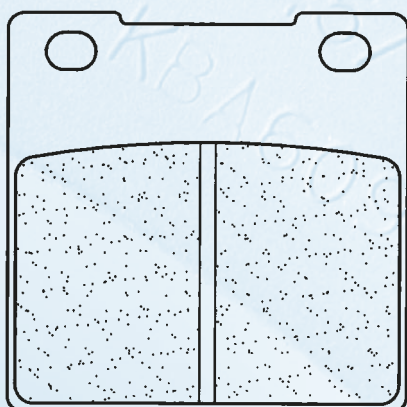

Dim./Size
 — 52,5 mm
 ↑ 52,5 mm
 H 8,5 mm

2282

HYOSUNG

| | | | | | |
|----|-----|-------|----|--|---|
| GT | 250 | Comet | 02 | | ● |
| GT | 600 | Comet | 02 | | ● |

KAWASAKI

| | | | | | |
|--------|------|------------------------|---------|---|---|
| Z | 250 | | 78 - 80 | | ● |
| Z | 250 | J / A3 | 81 | - | ● |
| ZX-4 | 400 | | 90 | | ● |
| ZXR | 400 | | 89 - 90 | | ● |
| ZXR | 400 | L1 / L2 / L3 / L4 / L5 | 91 - 02 | | ● |
| EN | 600 | R Ninja | 89 | - | ● |
| ZX7-R | 750 | Ninja | 89 - 95 | | ● |
| ZX7-R | 750 | Ninja | 96 - 02 | | ● |
| ZXR | 750 | R | 89 - 92 | | ● |
| ZXR | 750 | R | 93 - 95 | | ● |
| ZRX | 1100 | | 96 - 00 | | ● |
| ZX | 1100 | D1-D4 ZX 11 | 93 - 97 | | ● |
| ZZR | 1100 | | 94 - 01 | | ● |
| ZRX | 1200 | / S / R | 01 - 08 | | ● |
| ZX12-R | 1200 | Ninja | 00 - 03 | | ● |
| ZX12-R | 1200 | Ninja (Rad.Cal) | 04 | - | ● |
| ZZR | 1200 | | 02 | - | ● |

Street Sport Racing Enduro MX Off Road Racing ATV

S4 A3+ RX3

| SUZUKI | | | | | | |
|--------|-----|---------------------------------|---------|---|---|---|
| RG | 250 | Gamma WD | 83 - 84 | 1 | ● | ● |
| GSX | 400 | FW/FWS/FWS-2 | 83 - | 2 | ● | ● |
| GSX | 500 | E | 83 - | 2 | ● | ● |
| GS | 550 | ED / ESD / LD | 83 - | 1 | ● | ● |
| GSX | 550 | ESD/ESE/EFE/EFF/ESH/EFG (GN71D) | 83 - 87 | 2 | ● | ● |
| GSX | 750 | SE Katana | 85 | 2 | ● | ● |
| GF | 250 | S | 88 - | | | ● |
| GSF | 250 | Bandit | 90 - 96 | | | ● |
| GSF | 250 | VS / S Bandit | 97 - | | | ● |
| GSX | 250 | F - Across | 90 - 98 | | | ● |
| GSX | 250 | S Katana | 91 - | | | ● |
| GSX | 250 | S Cobra | 89 - | | | ● |
| GSX | 250 | RCH / H (GJ72A) | 87 | | | ● |
| GSX-R | 250 | | 88 - 89 | | | ● |
| GSX-R | 250 | R | 89 - | | | ● |
| RG | 250 | Gamma WE | 84 | | | ● |
| RG | 250 | Gamma | 85 - 88 | | | ● |
| RGV | 250 | Gamma J | 88 | | | ● |
| RGV | 250 | Gamma K / L | 89 - 90 | | | ● |
| TV | 250 | J / K / AK / L / Wolf | 88 - 90 | | | ● |
| SG | 350 | N Goose | 92 - | | | ● |
| GSF | 400 | Bandit M/N/P | 91 - 95 | | | ● |
| GSF | 400 | Bandit (GK75A) K/NK/Z/V/M/ZM/P | 89 - 94 | | | ● |
| GSF | 400 | Bandit (GK7AA) S/VS/V-V/Z-V | 95 - 97 | | | ● |
| GSX | 400 | X/XA/XS Impulse | 86 - | | | ● |
| GSX | 400 | FJ/FK/FAK/FL (GK74A) | 88 - 90 | | | ● |
| GSX | 400 | SSN Katana (GK77A) | 92 - | | | ● |
| GSX | 400 | | 94 - 96 | | | ● |
| GSX | 400 | X Impulse (GK79A) | 99 - | | | ● |
| GSX | 400 | FSV/FSK1 (GK7B) Inazuma | 00 - | | | ● |
| GSX-R | 400 | R2 (GK71B) | 80 - | | | ● |
| GSX-R | 400 | R3 (GK71F) | 83 - | | | ● |
| GSX-R | 400 | H | 87 | | | ● |
| GSX-R | 400 | J/RR/RAK (GK73A) | 88 - 90 | | | ● |
| GSX-R | 400 | RL/RM/RN/RP/RS (GK76A) | 90 - 95 | | | ● |
| RF | 400 | RP/RR/VR/RT/RVT/RV-V (GK78A) | 93 - 97 | | | ● |

2282 suite

| SUZUKI | | | | | | |
|--------|------|---------------------------------|---------|--|--|---|
| RG | 400 | Type 1 & 2 | 85 - 87 | | | ● |
| GS | 500 | E | 89 - 95 | | | ● |
| GS | 500 | E | 96 - 03 | | | ● |
| GS | 500 | F | 04 - 08 | | | ● |
| RG | 500 | CH / R Gamma | 85 - 87 | | | ● |
| GSF | 600 | S / N Bandit | 95 - 99 | | | ● |
| GSF | 600 | S / N Bandit | 00 - 04 | | | ● |
| GSX-F | 600 | FJ (GN72A) | 88 | | | ● |
| GSX-F | 600 | FK/FL/FM/FN/FP/FR/FS/FT/(GN72A) | 89 - 97 | | | ● |
| GSX-F | 600 | FW/FX/FY/FK1 to FK6 | 98 - 06 | | | ● |
| GSX-R | 600 | | 93 - 96 | | | ● |
| GSX-R | 600 | VW/X/Y/K1/K2/K3 | 97 - 03 | | | ● |
| RF | 600 | R (GN67A) | 93 - 97 | | | ● |
| SV | 650 | N / S | 99 - 02 | | | ● |
| GSX | 750 | W/X/Y/K1 Inazuma | 97 - 03 | | | ● |
| GSX-F | 750 | FK/FL/FM/FN/FP/FR/FS/FT/(GR78A) | 89 - 97 | | | ● |
| GSX-F | 750 | FW/FX/FY/FK1 to FK6 | 98 - 06 | | | ● |
| GSX-R | 750 | F / G / H | 85 - 87 | | | ● |
| GSX-R | 750 | RG | 86 | | | ● |
| GSX-R | 750 | J / K / L / M / WN / WP | 88 - 93 | | | ● |
| GSX-R | 750 | WR / WS | 94 - 95 | | | ● |
| GSX-R | 750 | T / V / W / X | 96 - 99 | | | ● |
| GSX-R | 750 | Y / K1 / K2 / K3 | 00 - 03 | | | ● |
| RF | 900 | RT / RV / RW | 96 - 99 | | | ● |
| TL | 1000 | S | 97 - 01 | | | ● |
| TL | 1000 | R | 98 - 02 | | | ● |
| GSX | 1100 | G | 96 - | | | ● |
| GSX | 1100 | Katana | 93 - | | | ● |
| GSX-R | 1100 | G / H / J (GV74B) | 86 - 88 | | | ● |
| GSX-R | 1100 | K / L / M / N (GV73B) | 89 - 92 | | | ● |
| GSX-R | 1100 | WP / WR / WS / WT (GV75A) | 93 - 97 | | | ● |
| GSF | 1200 | S / N Bandit | 95 - 00 | | | ● |
| GSF | 1200 | S / N Bandit ABS | 97 - | | | ● |
| GSF | 1200 | S / N Bandit K1-K5 | 01 - 05 | | | ● |
| GSX | 1200 | | 98 - 01 | | | ● |
| GSX-R | 1300 | Hayabusa | 99 - 07 | | | ● |

Street Sport Racing Enduro MX Off Road Racing ATV

S4 A3+ RX3

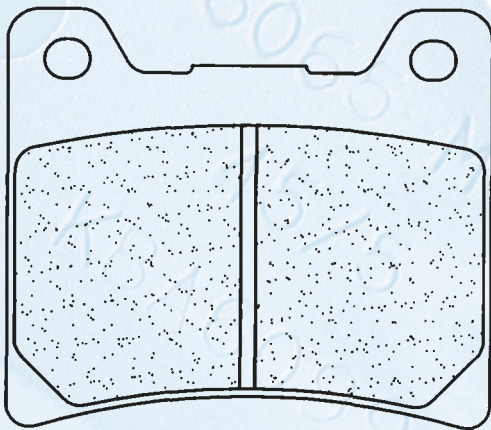

Dim./Size

→ 63,5 mm
↑ 54,8 mm
H 8,5 mm

2283

| NORTON | | | | | | |
|--------|--------------------|---------------|---------|---|---|---|
| 588 | Commander (Rotary) | 90 | 2 | ● | ● | |
| YAMAHA | | | | | | |
| FJ | 100 | L / LC | 84 - | 1 | ● | ● |
| TZR | 125 | (3PC2 / 3PC3) | 90 - 92 | 1 | ● | ● |
| FZ | 250 | Fazer N / S | 85 - 86 | 2 | ● | ● |
| RD | 250 | LC | 83 - | | | ● |
| RD | 350 | YPVS | 83 - 84 | | | ● |
| RZ | 350 | L / N / NC | 84 - 85 | | | ● |
| FZ | 400 | N | 85 | 2 | ● | ● |
| FZR | 400 | Genesis (1WG) | 86 | 2 | ● | ● |
| SRX | 400 | (1JL) | 85 - 86 | 1 | ● | ● |
| XS | 400 | Z | 83 - | 1 | ● | ● |
| XJ | 400 | | 82 | | | ● |
| RD | 500 | | 83 | 2 | ● | ● |
| RD | 500 | LC (RVZ500R) | 84 - 86 | 2 | ● | ● |
| RZ | 500 | | 84 - 86 | 2 | ● | ● |
| FJ | 600 | | 84 - | 2 | ● | ● |
| FZ | 600 | | 87 - 88 | 2 | ● | ● |
| FZR | 600 | | 89 | 2 | ● | ● |
| XJ | 600 | | 83 - 91 | 2 | ● | ● |
| YX | 600 | Radian | 86 - 90 | 2 | ● | ● |
| FZR | 600 | / R | 90 - 95 | | | ● |
| YZF | 600 | R Thunder Cat | 96 - 03 | | | ● |
| FZ | 700 | | 87 - | 2 | ● | ● |
| FZX | 700 | Fazer | 87 - | 2 | ● | ● |
| XJ | 700 | / Maxim | 85 - | 2 | ● | ● |
| XV | 700 | Virago | 84 - | 2 | ● | ● |
| FZ | 750 | | 85 - 88 | 2 | ● | ● |
| FZX | 750 | Fazer | 86 - | 2 | ● | ● |
| XV | 750 | Virago | 89 - 93 | 2 | ● | ● |
| FZ | 750 | | 89 - 91 | | | ● |
| FZR | 750 | R (OW01) | 89 - 90 | | | ● |
| FZR | 750 | R Genesis | 87 - 88 | | | ● |
| YZF | 750 | R / SP | 93 - 97 | | | ● |
| TDM | 850 | | 91 - 95 | | | ● |
| TDM | 850 | | 96 - 01 | | | ● |
| TRX | 850 | | 96 - 99 | | | ● |

Street Sport Racing Enduro MX Off Road Racing ATV

S4 A3+ RX3

| YAMAHA | | | | | | | |
|--------|------|------------------------------|---------|---|---|--|---|
| TRX | 850 | (Japan models) (Brembo Cal.) | 96 - 99 | | | | ● |
| XJ | 900 | / F | 83 - 93 | 2 | ● | | ● |
| XJ | 900 | S Diversion | 94 - 03 | | | | ● |
| XV | 1000 | Virago / SE Virago | 84 - | 2 | ● | | ● |
| FZR | 1000 | Genesis | 87 - 89 | | | | ● |
| FZR | 1000 | EXUP | 89 - 90 | | | | ● |
| FZR | 1000 | EXUP | 91 - 93 | | | | ● |
| FZR | 1000 | EXUP | 94 - 95 | | | | ● |
| GTS | 1000 | / ABS | 93 - 99 | | | | ● |
| YZF | 1000 | R Thunder Ace | 96 - 01 | | | | ● |
| FJ | 1100 | | 84 - 85 | 2 | ● | | ● |
| XV | 1100 | Virago | 86 - 93 | 2 | ● | | ● |
| BT | 1100 | Bulldog | 02 - 06 | | | | ● |

2283 suite

| YAMAHA | | | | | | | |
|--------|------|-------------------------------|---------|---|---|--|---|
| XV | 1100 | Virago | 99 | | | | ● |
| XVS | 1100 | Dragstar / A Dragstar Classic | 99 - 06 | | | | ● |
| XVS | 1100 | V-Star Custom | 05 - | | | | ● |
| FJ | 1200 | (ITX Type) | 86 - 87 | 2 | ● | | ● |
| XV | 1200 | V-Max | 85 - 92 | 2 | ● | | ● |
| XVZ | 1200 | TD Venture Royale | 85 | 2 | ● | | ● |
| FJ | 1200 | (3CV/CXW Type) | 88 - 95 | | | | ● |
| FJ | 1200 | A ABS | 91 - 95 | | | | ● |
| XJR | 1200 | / SP | 95 - 98 | | | | ● |
| XJR | 1200 | (Japan models) (Brembo Cal.) | 95 - 98 | | | | ● |
| XV | 1200 | V-Max | 93 - 01 | | | | ● |
| XJR | 1300 | (Japan models) (Brembo Cal.) | 98 - 99 | | | | ● |
| XJR | 1300 | / SP | 99 - 01 | | | | ● |

Street Sport Racing Enduro MX Off Road Racing ATV

S4 A3+ RX3

MX10 X59 ATV1

2284

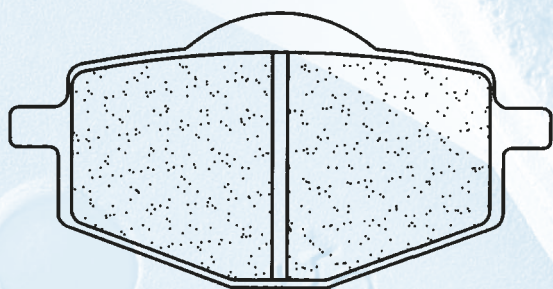

Dim./Size

71 mm

36,2 mm

9 mm

| GILERA | | | | | | | |
|--------|---------------|-----------------------|---------|---|---|--|---|
| 250 | Oregon Quad | | 07 - | 2 | ● | | ● |
| 125 | Apache | | 91 - | | | | ● |
| RC | 125 Top Rally | | 90 - | | | | ● |
| RC | 600 Top Rally | | 90 - | | | | ● |
| SACHS | | | | | | | |
| 650 | Roadster V1.6 | | 05 - | | | | ● |
| YAMAHA | | | | | | | |
| TDR | 50 | | 90 - | 1 | ● | | ● |
| YSR | 50 | A / B / D / T / U / W | 87 - 92 | 1 | ● | | ● |
| TZM | 50 | R | 94 - | | | | ● |

| YAMAHA | | | | | | | |
|--------|-----|-----------------|---------|---|---|--|---|
| TZR | 50 | | 90 - 92 | | | | ● |
| TZR | 50 | | 93 - 02 | | | | ● |
| DT | 80 | LC-2 (53V) | 85 - 92 | 1 | ● | | ● |
| RD | 80 | LC | 83 - | 1 | ● | | ● |
| TDR | 80 | | 89 | 1 | ● | | ● |
| YSR | 80 | | 86 - | 1 | ● | | ● |
| TZR | 80 | | 92 - | | | | ● |
| DT | 125 | LC | 85 - 87 | 1 | ● | | ● |
| DT | 125 | R | 88 - 03 | 1 | ● | | ● |
| DT | 125 | RE | 04 | 1 | ● | | ● |
| DT | 125 | RE | 05 - 07 | 1 | ● | | ● |
| YBR | 125 | (3D91) | 05 - 06 | 1 | ● | | ● |
| TDR | 125 | (4GW/GX1/2/3/4) | 93 - 03 | | | | ● |
| YZ | 125 | U | 88 | | | | ● |
| DT | 200 | R | 85 - 87 | 1 | ● | | ● |
| DT | 200 | R | 89 | 1 | ● | | ● |
| TT | 200 | | 85 - | 1 | ● | | ● |
| XT | 225 | Serrow | 86 - 93 | 1 | ● | | ● |
| XT | 225 | Serrow W | 93 - 98 | 1 | ● | | ● |
| TT | 225 | S / T | 87 - 00 | 1 | ● | | ● |
| TT-R | 225 | | 01 - 04 | 1 | ● | | ● |
| XT | 225 | | 86 - 91 | 1 | ● | | ● |
| XT | 225 | E - H | 92 - 00 | 1 | ● | | ● |
| TT | 250 | | 85 - | 1 | ● | | ● |
| TY-Z | 250 | R (Scottish) | 93 - 96 | 1 | ● | | ● |
| YTZ | 250 | TR1-Z N/S | 85 - 86 | 1 | ● | | ● |
| YZ | 250 | U (2T) | 88 | | | | ● |
| XT | 350 | | 85 - 90 | 1 | ● | | ● |
| XT | 350 | B-H | 91 - 95 | 1 | ● | | ● |
| YFM | 350 | Warrior XT/XU | 87 - 88 | 2 | ● | | ● |
| YFZ | 350 | Banshee (A-M) | 87 - 89 | 2 | ● | | ● |
| XT | 400 | Artesia | 91 - | | | | ● |
| WR | 500 | B | 91 | | | | ● |
| TT | 600 | N | 85 - 88 | 1 | ● | | ● |
| XT | 600 | | 87 - 89 | | | | ● |
| XT | 600 | E / K | 90 - 03 | | | | ● |
| XT | 600 | Z Ténéré | 88 - 90 | | | | ● |
| XTZ | 660 | Ténéré | 91 - 98 | | | | ● |

Street Sport Racing Enduro MX Off Road Racing ATV

S4 A3+ RX3

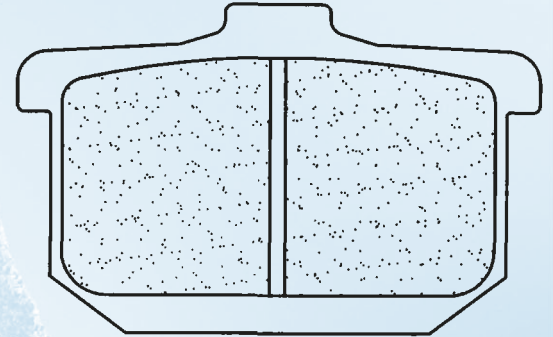
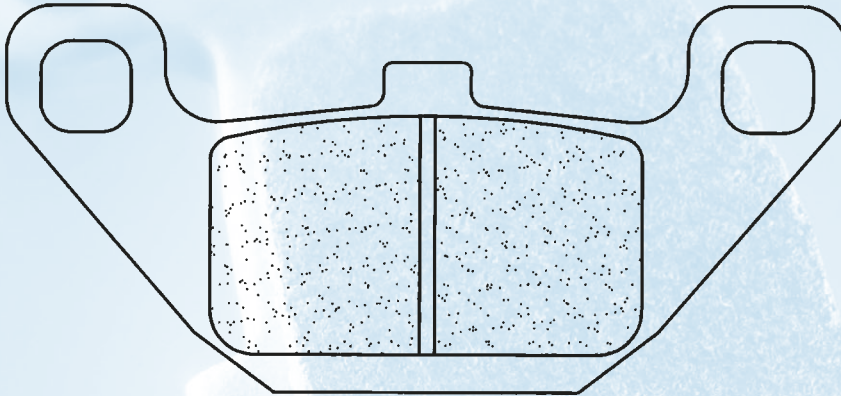

Dim./Size

→ 111 mm
↑ 51 mm
H 9,4 mm

2285

Dim./Size

→ 68,8 mm
↑ 43,5 mm
H 10 mm

HYOSUNG

| | | | | | | |
|-----------------|-----|-----------------|---------|---|---|---|
| GA | 300 | | 98 - | 1 | ● | |
| KAWASAKI | | | | | | |
| BR | 250 | | 86 - | 1 | ● | |
| CS | 250 | | 86 - | 1 | ● | |
| EL | 250 | E3 / E4 | 93 - 94 | 1 | ● | |
| EL | 250 | Eliminator | 88 - | 1 | ● | |
| EL | 250 | | 91 - 96 | 1 | ● | |
| EL | 250 | | 97 - | 1 | ● | |
| EX | 250 | R Ninja | 86 - 87 | 1 | ● | ● |
| GPZ | 250 | | 83 - | 2 | ● | |
| GPZ | 250 | R | 86 - | 1 | ● | ● |
| LX | 250 | Eliminator / SE | 90 - | 1 | ● | |
| Z | 250 | Eliminator | 88 | 1 | ● | |
| KR | 250 | | - 85 | | | ● |
| EL | 252 | Eliminator | 97 - 00 | 1 | ● | |
| EX | 305 | B1 | 83 | 1 | ● | |
| EX | 305 | GP | 83 - 96 | 2 | ● | |
| EN | 400 | Twin | 85 - | 1 | ● | |
| EN | 400 | Vulcan | 90 - | 1 | ● | |
| Z | 400 | Eliminator | 88 | 1 | ● | ● |
| ZX | 400 | | 86 - | 2 | ● | ● |
| | 400 | Eliminator | 94 - | | | ● |
| FX | 400 | R | 86 - 88 | | | ● |
| GPZ | 400 | | 85 - 87 | | | ● |
| ZX | 400 | | 85 | | | ● |
| EN | 450 | A1 / A6 | 85 - 90 | 1 | ● | |
| Z | 450 | LTD | 84 - | 1 | ● | |
| EN | 500 | A1-A7 / B1-B2 | 90 - 96 | 1 | ● | |
| EN | 500 | C1 - C2 Vulcan | 96 - 98 | 1 | ● | |
| EN | 500 | Vulcan Classic | 90 - | 1 | ● | |
| EN | 500 | | 98 - | 1 | ● | |
| ZL | 500 | (Austria) | 85 - | 1 | ● | |
| GPZ | 550 | | 84 - 87 | 2 | ● | ● |
| GT | 550 | | 85 - 01 | 2 | ● | |
| ZX | 550 | A1 / A1L | 84 - | 2 | ● | ● |
| Z | 550 | F | 85 - | 2 | ● | |
| GPZ | 600 | R | 85 - 93 | 2 | ● | ● |
| Z | 600 | GP | 83 - | 2 | ● | ● |
| ZL | 600 | | 85 - | 1 | ● | |

KAWASAKI

| | | | | | | |
|-----|------|--------------------------|---------|---|---|---|
| ZX | 600 | A1 / A2 / B1 Ninja | 85 - 87 | 2 | ● | ● |
| VN | 700 | A1 Vulcan | 85 | 2 | ● | |
| ZN | 700 | A1 / A1L | 84 - | 2 | ● | ● |
| GPZ | 750 | | 83 - 87 | 2 | ● | ● |
| GPZ | 750 | R | 85 - | 2 | ● | ● |
| GPZ | 750 | T | 83 - | 2 | ● | ● |
| GT | 750 | | 86 - | 2 | ● | ● |
| | 750 | Vulcan | 93 - | 1 | ● | |
| VN | 750 | A1-A12 Vulcan | 86 - 96 | 2 | ● | |
| VZ | 750 | Twin | 88 | 1 | ● | |
| Z | 750 | E1 / E1L / Turbo | 84 - | 2 | ● | ● |
| Z | 750 | Eliminator | 88 | 2 | ● | ● |
| Z | 750 | K1 / K2 | 83 - 84 | 2 | ● | |
| Z | 750 | LTD Twin | 83 - | 1 | ● | ● |
| ZX | 750 | A1 / E / GP | 83 - 85 | 2 | ● | ● |
| VN | 800 | A1 / A2 Vulcan / Classic | 95 - | 1 | ● | |
| GPZ | 900 | R | 84 - 89 | 2 | ● | ● |
| ZL | 900 | Eliminator | 85 - | 2 | ● | ● |
| ZX | 900 | A1 / A1L | 83 - 84 | 2 | ● | ● |
| GPZ | 1000 | RX | 86 - | 2 | ● | ● |
| GTR | 1000 | | 86 - 93 | 2 | ● | ● |
| Z | 1000 | R Ninja | 86 - | 2 | ● | ● |
| ZL | 1000 | | 86 - | 2 | ● | ● |
| GTR | 1000 | | 94 - 06 | | | ● |
| GPZ | 1100 | | 83 - 94 | 2 | ● | ● |
| Z | 1100 | GP | 83 - | 2 | ● | ● |
| Z | 1100 | LTD | 85 - | 2 | ● | ● |
| Z | 1100 | R LTD | 84 | 2 | ● | ● |
| ZN | 1100 | B1 / B1L / LTD | 84 - | 2 | ● | ● |
| ZX | 1100 | A1 / GP | 83 - | 2 | ● | ● |
| ZG | 1200 | B1-B10 Voyager | 86 - | 2 | ● | ● |
| Z | 1300 | 6 | 85 | 2 | ● | ● |
| ZN | 1300 | A1 / A2 / A2L | 83 - 84 | 2 | ● | ● |
| ZN | 1300 | Voyager | 85 - | 2 | ● | ● |
| VN | 1500 | A1-A10 Vulcan SE | 87 - 96 | 1 | ● | ● |
| VN | 1500 | B1-B4 / C1 / C2 Vulcan | 87 - 95 | 1 | ● | ● |
| VN | 1500 | Sumo | 88 - | 1 | ● | ● |
| VN | 1500 | Classic | 96 - | | | ● |
| VN | 1500 | Classic Tourer | 98 - | | | ● |
| VN | 1500 | Vulcan Nomad | 98 - | | | ● |

Street Sport Racing Enduro MX Off Road Racing ATV

S4 RX3



HONDA

| | | | | | | |
|----|-----|--------|---------|---|---|---|
| R | 50 | Monkey | 88 - | 1 | ● | |
| NS | 125 | | 89 | | | ● |
| RS | 125 | R | 91 - 94 | | | ● |
| RS | 125 | R | 95 - | | | ● |
| NS | 250 | | 89 | | | ● |
| RS | 250 | R | 93 - | | | ● |

2287

Dim./Size

→ 51,8 mm
↑↓ 36,6 mm
H 8 mm

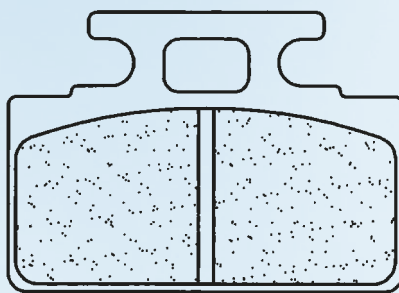

Street Sport Racing Enduro MX Off Road Racing ATV

S4 A3+ RX3

EN10 MX10

ATV1

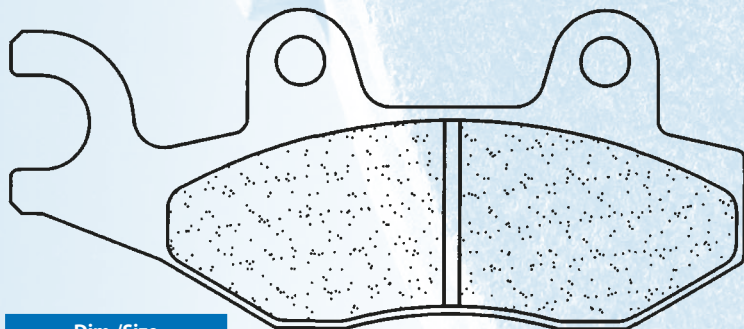

Dim./Size

→ 96,6 mm
↑↓ 42 mm
H 8 mm

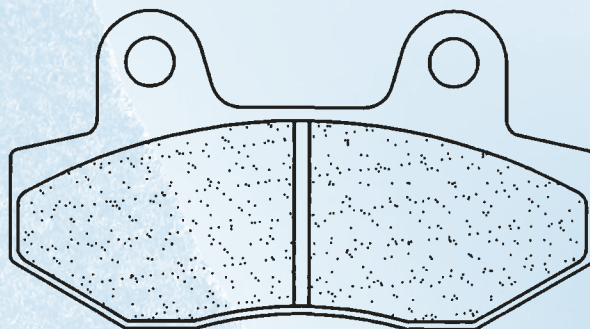

Dim./Size

→ 77 mm
↑↓ 42 mm
H 8 mm

2288

ALFER

| | | | | | |
|-----|--------|------|---|---|--|
| 125 | Enduro | 97 - | 1 | ● | |
| 250 | Enduro | 97 - | 1 | ● | |

| | | | | | |
|-----|------------|----|---|---|---|
| ATK | All models | 94 | 1 | ● | ● |
|-----|------------|----|---|---|---|

| | | | | | | |
|--------|-----|------------|------|-----|---|--|
| CAGIVA | 110 | Passing | 94 - | 1 | ● | |
| | 500 | Canyon | 99 - | 1 | ● | |
| | 600 | Canyon | 96 | 1 | ● | |
| | 900 | E.I Canyon | 98 | L 1 | ● | |

| | | | | | | | |
|-------|-----|-----|---------|---------|---|---|---|
| HONDA | CA | 125 | Rebel | 95 - 96 | 1 | ● | |
| | NSR | 150 | | 02 - | | | ● |
| | CMX | 250 | C Rebel | 96 - | 1 | ● | |

| | | | | | | |
|-----|-----|-----|----|---|---|--|
| HRD | 125 | GSE | 96 | 1 | ● | |
| | 250 | GSE | 96 | 1 | ● | |

| | | | | | | | |
|----------|----|-----|--|------|---|---|--|
| JINCHENG | JC | 250 | | 06 - | 1 | ● | |
|----------|----|-----|--|------|---|---|--|

| | | | | | | | |
|----------|-----|-----|-------------------------|---------|-----|---|--|
| KAWASAKI | KLX | 125 | | 10 - | 1 | ● | |
| | KLX | 125 | D-Tracker | 10 - | 1 | ● | |
| | KLX | 250 | S / SF | 09 - | 1 | ● | |
| | EL | 252 | Eliminator | 01 - | 1 | ● | |
| | KLR | 650 | | 08 - | 1 | ● | |
| | KX | 125 | G / H / J | 89 - 93 | 1 | ● | |
| | KDX | 200 | E5 | 93 | 1 | ● | |
| | KX | 250 | G1 / H1 / H2 / J1 / J2 | 89 - 93 | 1 | ● | |
| | KDX | 250 | SR / D1 / D2 / D3 / D4 | 91 - 94 | 1 | ● | |
| | KX | 500 | E1 / E2 / E3 / E4 / E5 | 89 - 93 | 1 | ● | |
| | KLF | 300 | C1-C12 Bayou | 89 - 05 | L 1 | ● | |
| | KLF | 400 | B1-B7 Bayou | 93 - 99 | L 1 | ● | |
| | KVF | 650 | Brute Force 4X4 i F/G/H | 07 - | L 1 | ● | |
| | KRF | 750 | Teryx 4x4 | 08 - | L 1 | ● | |
| | KVF | 750 | Brute Force 4X4 i | 04 - | L 1 | ● | |

| | | | | | | |
|--------|-----|-------------|------|---|---|--|
| KEEWAY | 125 | Superlight | 06 - | 1 | ● | |
| | 150 | Superlight | 06 - | 1 | ● | |
| | 250 | Landcruiser | 06 - | 1 | ● | |

| | | | | | | |
|----------|-----|-----------|------|---|---|--|
| KREIDLER | 125 | Enduro | 07 - | 1 | ● | |
| | 125 | Supermoto | 07 - | 1 | ● | |
| | 200 | Enduro | 07 - | 1 | ● | |

| | | | | | | |
|-------|-----|---------|---------|---|---|--|
| KYMCO | 125 | Stryker | 01 - 06 | 1 | ● | |
| | 150 | Stryker | 05 - | 1 | ● | |

| | | | | | | |
|----------|-----|--------------------|---------|---|---|--|
| MZ / MUZ | 125 | SM/SX (All models) | 02 - 07 | 1 | ● | |
|----------|-----|--------------------|---------|---|---|--|

| | | | | | | | |
|--------|------|-----|------------------------------|---------|-----|---|--|
| SUZUKI | EN | 125 | 125-2 / 125-2A | 05 - | 1 | ● | |
| | TS | 125 | R | 89 - 96 | 1 | ● | |
| | TS | 200 | R | 89 - 94 | 1 | ● | |
| | DR | 250 | SL/SM/SN/SEP/SER/SES (SJ44A) | 90 - 95 | 1 | ● | |
| | DR | 350 | SL/SM/SN/SP | 90 - 93 | 1 | ● | |
| | DR | 350 | SER/SES | 94 - 95 | 1 | ● | |
| | DR | 350 | SET/SEV | 96 - 97 | 1 | ● | |
| | RM | 125 | H | 87 | 1 | ● | |
| | RM | 125 | J | 88 | 1 | ● | |
| | RM | 125 | K / L / M | 89 - 91 | 1 | ● | |
| | RM | 125 | N / P / R / S | 92 - 95 | 1 | ● | |
| | RM | 250 | H / J | 87 - 88 | 1 | ● | |
| | RM | 250 | K / L / M | 89 - 91 | 1 | ● | |
| | RM | 250 | N / P / R / S | 92 - 95 | 1 | ● | |
| | RMX | 250 | K / L / M / N / P / R / S | 89 - 95 | 1 | ● | |
| | RM | 500 | H | 87 - | 1 | ● | |
| | LT-F | 300 | King Quad | 02 - | L 1 | ● | |
| | LT-R | 450 | Quad Racer | 06 - | L 1 | ● | |
| | LT-A | 500 | FY1/FK1 Quadmaster | 00 - | L 1 | ● | |
| | LT-F | 500 | FW/FX/FY2 Quadrunner | 98 - 02 | L 1 | ● | |

| | | | | | | |
|---------|------|-----------------------------------|---------|-----|---|--|
| TRIUMPH | 750 | Trident | 91 - 98 | R 1 | ● | |
| | 900 | Sprint | 93 | R 1 | ● | |
| | 900 | Tiger | 92 - 98 | R 1 | ● | |
| | 900 | Trident | 91 - 98 | R 1 | ● | |
| | 900 | Trophy | 91 - 95 | R 1 | ● | |
| | 1000 | Trophy | 92 - 95 | R 1 | ● | |
| | 1200 | Trophy | 91 - 95 | R 1 | ● | |
| | 800 | America | 03 - 06 | | ● | |
| | 800 | Bonneville | 01 - 04 | | ● | |
| | 800 | Bonneville / America / T100 | 02 - | | ● | |
| | 800 | Speedmaster | 03 - 04 | | ● | |
| | 900 | America | 07 - | | ● | |
| | 900 | Bonneville / Bonneville SE / T100 | 09 - | | ● | |
| | 900 | Scrambler | 06 - | | ● | |
| T 509 | 900 | Speed Triple | 97 - 98 | | ● | |
| | 900 | Speedmaster | 05 - | | ● | |
| | 900 | Thurxton | 04 - | | ● | |
| T 595 | 950 | Daytona | 97 - 98 | | ● | |

1 - 2 = Nombre de jeux / Number of sets
L = Gauche / Left - R = Droite / Right

TRIUMPH

| | | | | |
|------|-------------------------------|---------|--|---|
| 955 | Daytona | 99 - 06 | | ● |
| 955 | Daytona Centennial | 02 | | ● |
| 955 | Speed Triple | 99 - 04 | | ● |
| 955 | Sprint RS | 99 - 04 | | ● |
| 955 | Sprint ST | 99 - 04 | | ● |
| 1050 | Speed Triple (Nissin Rad.Cal) | 05 - 07 | | ● |
| 1050 | Speed Triple (Brembo Rad.Cal) | 08 - 10 | | ● |
| 1050 | Sprint ST | 05 - 09 | | ● |
| 1050 | Sprint ST ABS | 09 - | | ● |
| 1050 | Tiger SE (ABS) | 09 - | | ● |

YAMAHA

| | | | | |
|-----|---------------------|-----------|---|---|
| FZR | 50 | 92 - | 1 | ● |
| YD | 80 | 89 - | 1 | ● |
| XTZ | 125 (5RM) | 03 - | 1 | ● |
| DT | 200 WR | 91 - 93 | 1 | ● |
| DT | 230 Lanza | 97 - 98 | 1 | ● |
| XTZ | 750 Super Ténéré | 89 - 94 L | 1 | ● |
| WR | 125 | 91 - 97 | 1 | ● |
| YZ | 125 V / W | 89 | 1 | ● |
| YZ | 125 A/B/D/E/F/G/H/J | 90 - 97 | 1 | ● |
| WR | 200 R | 91 - 94 | 1 | ● |
| TT | 250 R | 93 - 04 | 1 | ● |

2288 suite

YAMAHA

| | | | | | | |
|-----|-----|----------------------------------|-----------|---|---|---|
| WR | 250 | ZB / ZD / ZE / ZF / ZG / ZH / ZJ | 91 - 97 | 1 | ● | |
| YZ | 250 | W / WRW (2T) | 89 | 1 | ● | |
| YZ | 250 | A / WRA / B (2T) | 90 - 91 | 1 | ● | |
| YZ | 250 | D / E / F / G / H / J (2T) | 92 - 97 | 1 | ● | |
| YZ | 360 | | 89 | 1 | ● | |
| WR | 500 | B | 91 | 1 | ● | |
| WR | 500 | ZD / ZE | 92 - 93 | 1 | ● | |
| YFZ | 450 | S / T / R | 04 - 05 L | 1 | ● | |
| YFZ | 450 | V / W / X | 06 - 08 L | 1 | ● | |
| YFZ | 450 | RY / RZ | 09 - | L | 1 | ● |
| YXR | 450 | Rhino | 06 - | L | 1 | ● |
| YXR | 660 | Rhino | 04 - 06 L | 1 | ● | |
| YFM | 700 | R Raptor | 06 - | L | 1 | ● |

Street Sport Racing Enduro MX Off Road Racing ATV

S4 A3+ RX3

HONDA

| | | | | | |
|-----|------|-----------------|---------|---|---|
| CB | 125 | TDC | 83 - 89 | 1 | ● |
| CBX | 250 | RSE | 84 - | 1 | ● |
| GB | 250 | Clubman | 88 - | 1 | ● |
| | 400 | Xelvis | | 1 | ● |
| CB | 400 | Four | 81 - | 2 | ● |
| CB | 400 | Hawk | 81 - | 1 | ● |
| CB | 400 | N | 82 - 85 | 1 | ● |
| CB | 400 | Twin | 82 - | 1 | ● |
| CB | 400 | | 82 - | 2 | ● |
| CBR | 400 | F / Fil | 85 | 2 | ● |
| CM | 400 | T | 82 - | 1 | ● |
| GB | 400 | TT | 88 - | 1 | ● |
| CB | 450 | T | 82 - | 1 | ● |
| CM | 450 | A / C | 82 - | 1 | ● |
| CMX | 450 | Rebel | 86 - | 1 | ● |
| CX | 500 | C | 81 - 82 | 2 | ● |
| CX | 500 | Silver W Turbo | 83 - | 2 | ● |
| CX | 500 | Turbo | 82 - | 2 | ● |
| FT | 500 | | 82 - | 2 | ● |
| GB | 500 | TT | 88 - | 1 | ● |
| GL | 500 | D | 81 - | 2 | ● |
| NS | 500 | R | 85 - | 2 | ● |
| VF | 500 | F / Fil | 84 - 86 | 2 | ● |
| VT | 500 | C Shadow | 83 - 86 | 1 | ● |
| XBR | 500 | S | 85 - | 1 | ● |
| CB | 550 | SC | 83 - | 1 | ● |
| CBX | 600 | E | 85 - | 2 | ● |
| VT | 600 | C Shadow | 88 | 1 | ● |
| XL | 600 | LM / RM | 85 - | 1 | ● |
| XL | 600 | V Transalp | 87 - 90 | 1 | ● |
| CB | 650 | SC Nighthawk | 83 - 85 | 2 | ● |
| CB | 650 | | 85 - | 2 | ● |
| CBX | 650 | ED / SC / SCD | 83 - | 2 | ● |
| CX | 650 | C | 83 - | 2 | ● |
| CX | 650 | Turbo | 83 - | 2 | ● |
| GL | 650 | D | 83 - | 2 | ● |
| CB | 700 | SC | 84 - 86 | 2 | ● |
| VF | 700 | C Magna | 84 | 2 | ● |
| VF | 700 | C Magna | 87 | 1 | ● |
| VF | 700 | S | 84 - 85 | 2 | ● |
| VT | 700 | C Shadow | 87 | 1 | ● |
| CB | 750 | C | 82 - | 2 | ● |
| CB | 750 | C / F / Fil / K | 85 - | 2 | ● |
| CB | 750 | F | 81 - 82 | 2 | ● |
| CB | 750 | K | 81 - | 2 | ● |
| CB | 750 | KZ | 82 - | 1 | ● |
| CBX | 750 | F | 84 - | 2 | ● |
| CBX | 750 | | 84 - | 2 | ● |
| NV | 750 | CG Shadow | 86 - | 1 | ● |
| VF | 750 | C | 82 - | 2 | ● |
| VF | 750 | C Magna | 88 - 93 | 1 | ● |
| VF | 750 | F | 83 - | 2 | ● |
| VF | 750 | S | 85 - | 2 | ● |
| VF | 750 | Sport | 82 - 83 | 2 | ● |
| VP | 750 | CH Custom | 87 - | 1 | ● |
| VT | 750 | C Shadow | 86 - 96 | 1 | ● |
| XLV | 750 | R | 83 - 85 | 1 | ● |
| VT | 800 | C | 88 - | 1 | ● |
| CB | 900 | C | 82 - | 2 | ● |
| CB | 1000 | C | 83 - | 2 | ● |

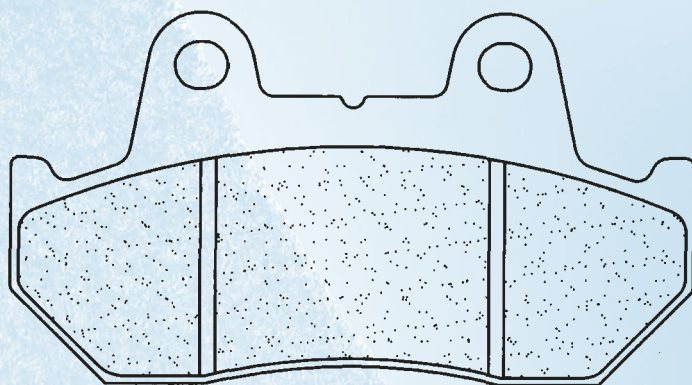

2289

Dim./Size

→ 90 mm

↓ 49 mm

H 11 mm

HONDA

| | | | | | |
|-----|------|---------------------------|---------|---|---|
| VF | 1000 | F / Fil | 84 - 86 | 2 | ● |
| VF | 1000 | Fil Bol d'Or | 85 | 2 | ● |
| VF | 1000 | R | 84 - 85 | 2 | ● |
| VF | 1000 | R | 86 - | 2 | ● |
| VT | 1000 | C | 88 - | 1 | ● |
| CB | 1100 | F | 83 - | 2 | ● |
| CB | 1100 | R / RD | 80 - 83 | 2 | ● |
| GL | 1100 | A1 / DLX / C / S Goldwing | 81 - | 2 | ● |
| VT | 1100 | C Shadow | 87 - 93 | 1 | ● |
| GL | 1200 | A Goldwing | 84 - | 2 | ● |
| GL | 1200 | DX Goldwing | 86 - | 2 | ● |
| GL | 1200 | Goldwing | 84 - | 2 | ● |
| NS | 250 | R | 85 | | ● |
| NSR | 250 | R | 87 - | | ● |
| CBR | 400 | R | 87 | | ● |
| NS | 400 | R | 85 - 87 | | ● |
| NV | 400 | Custom | 88 | | ● |
| CBR | 500 | F (Austria) | 87 - 90 | | ● |
| GL | 500 | | 82 | | ● |
| CBR | 600 | F Hurricane | 87 - 90 | | ● |
| CX | 650 | E | 83 - | | ● |
| VF | 700 | F Interceptor | 84 - 85 | | ● |
| VFR | 700 | F / F2 | 86 - 87 | | ● |
| CBR | 750 | Hurricane | 87 - | | ● |
| VFR | 750 | F | 86 - 87 | | ● |
| CB | 900 | F / F2 | 81 - 84 | | ● |
| CBR | 1000 | F | 87 - 88 | | ● |
| CBX | 1000 | | 81 - 82 | | ● |
| VF | 1100 | C | 83 - 86 | | ● |
| VF | 1100 | S | 84 - 85 | | ● |
| GL | 1500 | Goldwing / SE | 88 - 93 | | ● |
| GL | 1500 | Goldwing Aspencade SE | 94 - | | ● |
| GLX | 1500 | | 88 - | | ● |
| CBR | 600 | F Hurricane | 87 - 90 | | ● |

Street Sport Racing Enduro MX Off Road Racing ATV

S4 RX3

2296

Dim./Size
 → 86 mm
 ↑ 40,1 mm
 H 8,9 mm

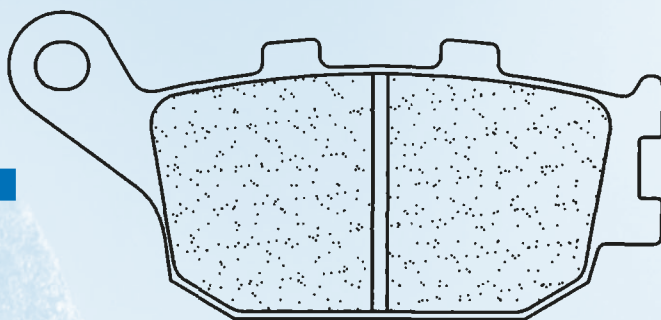

| HONDA | | | |
|-----------------------------------|--|---------|---|
| CBR 400 F | | 92 - | ● |
| CBF 500 ABS | | 04 - | ● |
| CBF 500 | | 04 - | ● |
| CB 600 Hornet (Japan model) | | 98 - | ● |
| CB 600 F Hornet | | 98 - 06 | ● |
| CB 600 F Hornet S | | 00 - | ● |
| CB 600 Hornet ABS | | 07 - | ● |
| CB 600 Hornet Wakizashi | | 06 | ● |
| CBF 600 N / S - ABS | | 04 - 07 | ● |
| CBF 600 N / S - ABS | | 08 - | ● |
| CBR 600 F 4 / F 4 Sport | | 99 - 00 | ● |
| CBR 600 F / FS | | 01 - | ● |
| CBR 600 F 3 | | 95 - 98 | ● |
| CBR 600 F / F Supersport | | 91 - 94 | ● |
| CBR 600 RR | | 03 - 04 | ● |
| CBR 600 RR (Rad.cal) | | 05 - 06 | ● |
| FMX 650 | | 05 - | ● |
| XL 700 Transalp | | 08 - | ● |
| CB 750 N / F Seven Fifty | | 92 - | ● |
| NR 750 | | 92 | ● |
| CB 900 Hornet (919) | | 02 - | ● |
| CBR 900 RR Fireblade | | 92 - 97 | ● |
| CBR 900 RR Fireblade | | 98 - 99 | ● |
| CBR 900 RR Fireblade (929) | | 00 - 01 | ● |
| CBR 900 RR Fireblade (954) | | 02 - 03 | ● |
| CB 1000 F Big One | | 93 - 97 | ● |
| CBF 1000 | | 06 - | ● |
| CBF 1000 Limited Edition | | 09 - | ● |
| CBR 1000 RR Fireblade (Rad.cal) | | 04 - 05 | ● |
| VTR 1000 F Firestorm / Super Hawk | | 97 - 06 | ● |
| VTR 1000 SP-1 | | 00 - 01 | ● |
| VTR 1000 SP-2 | | 02 - 07 | ● |
| VT 1100 C2 Shadow | | 95 - | ● |
| VT 1100 C3 Shadow | | 98 - | ● |
| VT 1100 T Shadow | | 98 - | ● |
| CB 1300 Super Four | | 03 - 09 | ● |
| CB 1300 Super Four ABS | | 05 - 09 | ● |
| VTX 1300 C / S | | 03 - | ● |

| KAWASAKI | | | |
|-----------------------------------------|--|---------|---|
| Z 750 / ABS | | 07 - | ● |
| Z 750 R | | 11 - | ● |
| KLX 1000 | | 04 - | ● |
| Z 1000 | | 07 - 09 | ● |
| Z 1000 (Rad.Cal) | | 10 - | ● |
| Z 1000 SX (Rad.Cal) | | 11 - | ● |
| SUZUKI | | | |
| DL 650 V-Strom | | 04 - | ● |
| DL 650 V-Strom ABS | | 07 - | ● |
| GSF 650 Bandit / Bandit S | | 07 - | ● |
| GSF 650 Bandit ABS / Bandit S ABS | | 07 - | ● |
| GSX 650 F | | 08 - | ● |
| SV 650 N / S | | 03 - | ● |
| SV 650 N ABS / S ABS | | 07 - | ● |
| DL 1000 V-Strom K2-K9 | | 02 - 09 | ● |
| SV 1000 S / N K3 -K7 | | 03 - 07 | ● |
| GSF 1200 S / N Bandit K6 | | 06 | ● |
| GSF 1200 S / N Bandit ABS K6 | | 06 | ● |
| GSF 1250 S / N Bandit (K7/K8/K9/L0) | | 07 - 10 | ● |
| GSF 1250 S / N Bandit ABS (K7/K8/K9/L0) | | 07 - 10 | ● |
| GSF 1250 FA Traveller | | 10 - | ● |
| GSX 1300 B-king | | 07 | ● |
| YAMAHA | | | |
| FZ6 600 N / Fazer | | 04 - 07 | ● |
| FZ6 600 N / Fazer ABS | | 06 - 07 | ● |
| FZ6 600 N / Fazer S2 | | 07 - 09 | ● |
| FZ6 600 N / Fazer S2 ABS | | 08 | ● |
| YZF 600 R6 | | 03 - 05 | ● |
| YZF 600 R6 | | 06 - 09 | ● |
| YZF 600 R6 | | 10 - | ● |
| FZ8 800 | | 10 - | ● |
| FZ8S 800 Fazer | | 10 - | ● |
| FZ-1 1000 N / Fazer | | 06 - | ● |
| FZ-1 1000 N / Fazer ABS | | 08 - | ● |
| YZF 1000 R1 / R1 SP | | 04 - 06 | ● |
| YZF 1000 R1 (Rad.cal) | | 07 - 08 | ● |
| YZF 1000 R1 (Rad.cal) | | 09 - | ● |

Street Sport Racing Enduro MX Off Road Racing ATV

S4 RX3

2298

Dim./Size
 → 86 mm
 ↑ 40,1 mm
 H 10 mm

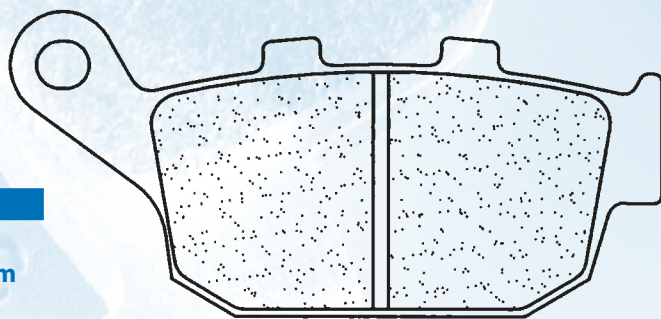

| BUELL | | | |
|-----------------------------|--|---------|---|
| 500 Blast | | 01 - | ● |
| XB-9R 984 Firebolt | | 02 - | ● |
| XB-9S 984 Lightning | | 03 - | ● |
| XB-9SX 984 Lightning City X | | 04 - | ● |
| M2 1200 Cyclone | | 94 - 97 | ● |
| S1 1200 Lightning | | 94 - 97 | ● |
| S3 1200 Thunderbolt | | 94 - 97 | ● |
| S3T 1200 Thunderbolt | | 94 - 97 | ● |
| S3T 1200 Thunderbolt | | 98 - 02 | ● |
| X1 1200 Lightning | | 98 - 02 | ● |
| XB-12R 1200 Firebolt | | 04 - 08 | ● |
| XB-12R 1200 Firebolt | | 09 - | ● |
| XB-12S 1200 Lightning | | 04 - 08 | ● |
| XB-12Scg1200 Lightning | | 06 - 08 | ● |

| BUELL | | | |
|-----------------------------|--|---------|---|
| XB-12Scg1200 Lightning | | 09 - | ● |
| XB-12Ss 1200 Lightning Long | | 06 - 08 | ● |
| XB-12Ss 1200 Lightning Long | | 09 - | ● |
| XB-12STT1200 Supet TT | | 07 - | ● |
| XB-12X 1200 Ulysses | | 06 - | ● |
| HONDA | | | |
| CBR 250 Hurricane | | 87 - | ● |
| CBR 250 R / RR | | 90 | ● |
| CBR 250 RJ | | 88 | ● |
| NSR 250 RJ | | 88 - | ● |
| NSR 250 R / SP | | 90 | ● |
| RS 250 R | | 91 - 92 | ● |
| VT 250 Spada | | 89 | ● |
| VTR 250 | | 98 - | ● |
| CB 400 Super Four | | 92 - 95 | ● |

2298 suite

HONDA

| | | | | |
|------|-----|---------------------|---------|---|
| CB-1 | 400 | (CB 400 F) | 89 - 90 | ● |
| CBR | 400 | RR | 87 - | ● |
| CBR | 400 | R | 88 - 93 | ● |
| NTV | 400 | Bros II | 88 | ● |
| VFR | 400 | R NC30 | 89 - | ● |
| VRX | 400 | T Roadstar | 95 - | ● |
| NX | 500 | Dominator (Austria) | 88 - 92 | ● |
| NX | 500 | Dominator (Austria) | 93 - 96 | ● |
| NTV | 600 | Bros | 88 - | ● |
| NTV | 600 | Révéré | 88 - | ● |
| XL | 600 | V Transalp | 91 - 93 | ● |
| XL | 600 | V Transalp | 94 - 96 | ● |
| XL | 600 | V Transalp | 97 - 99 | ● |
| NT | 650 | Hawk GT | 88 - 91 | ● |
| NT | 650 | V Deauville | 98 - 01 | ● |
| NTV | 650 | Bros | 88 - | ● |
| NTV | 650 | Revere | 88 - 93 | ● |
| NTV | 650 | | 94 - | ● |
| NX | 650 | Dominator | 93 - 96 | ● |
| NX | 650 | Dominator J / K | 88 - 92 | ● |
| XL | 650 | V Transalp | 00 - | ● |
| XR | 650 | Africa Twin | 88 - 90 | ● |
| VFR | 700 | F Interceptor | 88 - 89 | ● |
| XR | 750 | Africa Twin | 90 - 92 | ● |
| XR | 750 | Africa Twin | 93 - 03 | ● |

SUZUKI

| | | | | |
|----------------|-----|-------------------|---------|---|
| SFV | 650 | Gladius | 09 - | ● |
| XF | 650 | Freewind | 97 - 02 | ● |
| TRIUMPH | | | | |
| | 600 | Daytona | 03 - 04 | ● |
| | 600 | Speed Four | 02 - 05 | ● |
| | 600 | TT | 00 - 03 | ● |
| | 650 | Daytona | 05 | ● |
| | 675 | Daytona (Rad.cal) | 06 - 08 | ● |
| | 675 | Daytona (Rad.cal) | 09 - | ● |
| | 675 | Street Triple | 07 - | ● |
| | 675 | Street Triple R | 09 - | ● |
| YAMAHA | | | | |
| XJ6 | 600 | / ABS | 09 - | ● |
| XJ6 | 600 | Diversion / ABS | 09 - | ● |
| XJ6 | 600 | Diversion F / ABS | 10 - | ● |

| Street | Sport | Racing | Enduro | MX | Off Road Racing | ATV |
|--------|-------|--------|--------|----|-----------------|-----|
| S4 | RX3 | | | | X59 | |

2299

Dim./Size

→ 62 mm
↑↓ 40,8 mm
┌┐ 9 mm

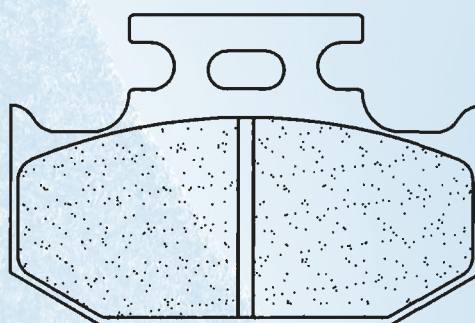

ALFER

| | | | | |
|-------------------|-----|--------------------------------|---------|---|
| | 125 | Enduro | 97 - | ● |
| | 250 | Enduro | 97 - | ● |
| CANNONDALE | | | | |
| S | 440 | SM | 03 - | ● |
| MX | 400 | | 00 - | ● |
| | 440 | C / E / X | 03 - | ● |
| HRD | | | | |
| | 125 | GSE | 96 | ● |
| | 250 | GSE | 96 | ● |
| KAWASAKI | | | | |
| KDX | 125 | A / B | 90 - | ● |
| KX | 125 | G / H / J | 89 - 93 | ● |
| KX | 125 | K1 | 94 | ● |
| KDX | 200 | SR / E1 / E4 | 89 - 92 | ● |
| KDX | 200 | E5 | 93 | ● |
| KDX | 200 | E6 / H1 / H2 / H3 | 94 - 99 | ● |
| KDX | 220 | R A4 | 97 - | ● |
| KLX | 250 | R | 93 - 94 | ● |
| KLX | 250 | ES | 94 - 97 | ● |
| KLX | 250 | D1-D4 / ES | 93 - 96 | ● |
| KX | 250 | G1 / H1 / H2 / J1 / J2 | 89 - 93 | ● |
| KX | 250 | K1 | 94 | ● |
| KDX | 250 | SR / D1 / D2 / D3 / D4 | 91 - 94 | ● |
| KX | 500 | E1 / E2 / E3 / E4 / E5 | 89 - 93 | ● |
| KX | 500 | E6 / E7 | 94 - 95 | ● |
| KLX | 650 | A1-A3 / C1-C4 | 93 - 96 | ● |
| KLX | 650 | R | 93 - 95 | ● |
| KLX | 650 | R | 93 - 95 | ● |
| SUZUKI | | | | |
| TS | 125 | R | 89 - 96 | ● |
| TS | 200 | R | 89 - 94 | ● |
| DR | 250 | SL/SM/SN/SEP/SER/SES (SJ44A) | 90 - 95 | ● |
| DR | 250 | RS/RLS/RT/RLV/RLW (SJ45A) DOHC | 90 - 95 | ● |
| DR | 250 | RXT/RXLT/RXV/Djebel XC (SJ45A) | 96 - 98 | ● |

SUZUKI

| | | | | |
|---------------|-----|----------------------------|---------|---|
| DR | 350 | SL/SM/SN/SP | 90 - 93 | ● |
| DR | 350 | SER/SES | 94 - 95 | ● |
| DR | 350 | SET/SEV | 96 - 97 | ● |
| DR | 350 | SEW/SEX | 98 - 99 | ● |
| DR | 650 | SE (SP46A/B) | 96 - 97 | ● |
| RM | 125 | K / L / M | 89 - 91 | ● |
| RM | 125 | N / P / R / S | 92 - 95 | ● |
| DR-Z | 250 | K1 / K7 | 01 - 07 | ● |
| RM | 250 | K / L / M | 89 - 91 | ● |
| RM | 250 | N / P / R / S | 92 - 95 | ● |
| RMX | 250 | K / L / M / N / P / R / S | 89 - 95 | ● |
| RMX | 250 | T / V / W | 96 - 98 | ● |
| YAMAHA | | | | |
| FZR | 50 | | 92 - | ● |
| YD | 80 | | 89 - | ● |
| DT | 125 | RE | 05 - 07 | ● |
| DT | 125 | X Supermotard | 05 - 06 | ● |
| WR | 125 | | 91 - 97 | ● |
| YZ | 125 | A/B/D/E/F/G/H/J | 90 - 97 | ● |
| DT | 200 | WR | 91 - 93 | ● |
| WR | 200 | R | 91 - 94 | ● |
| XT | 225 | Serrow W | 93 - 98 | ● |
| DT | 230 | Lanza | 97 - 98 | ● |
| XG | 250 | Tricker | 04 - 06 | ● |
| XT | 250 | X Supermotard | 06 - 08 | ● |
| TT | 250 | R | 93 - 04 | ● |
| TY-Z | 250 | R (Scottish) | 93 - 96 | ● |
| WR | 250 | ZB/ ZD/ ZE/ ZF/ ZG/ ZH/ZJ | 91 - 97 | ● |
| YZ | 250 | A / WRA / B (2T) | 90 - 91 | ● |
| YZ | 250 | D / E / F / G / H / J (2T) | 92 - 97 | ● |
| WR | 400 | FK (4T) | 98 | ● |
| YZ | 400 | FK (4T) | 98 | ● |
| WR | 500 | ZD / ZE | 92 - 93 | ● |
| TT | 600 | E (Belgarda) | 94 - 95 | ● |
| TT | 600 | K (Belgarda) | 93 - 95 | ● |

Street Sport Racing Enduro MX Off Road Racing ATV

S4 A3+ XBK5 EN10 MX10 ATV1

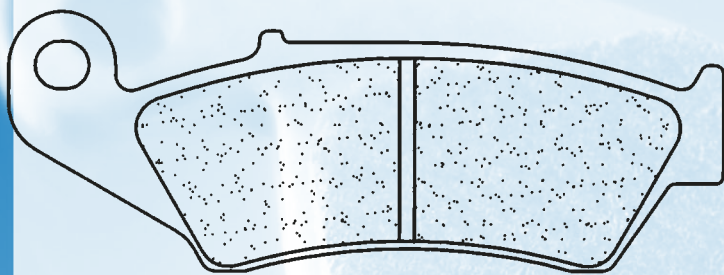

Dim./Size

94 mm

34 mm

6,8 mm

2300

| | | | | | |
|-------------------|-----|------------------------|---------|---|---|
| AJP | | | | | |
| PR5 | 250 | Supermotard | 09 - | 1 | ● |
| PR5 | 250 | Enduro | 09 - | 1 | ● |
| APRILIA | | | | | |
| MXV | 450 | | 09 - | 1 | ● |
| RXV | 450 | Enduro | 06 - | 1 | ● |
| RXV | 550 | Enduro | 06 - | 1 | ● |
| BETA | | | | | |
| RR | 250 | Enduro | 05 - | 1 | ● |
| RR | 400 | Enduro | 05 - | 1 | ● |
| RR | 450 | Enduro | 05 - | 1 | ● |
| RR | 525 | Enduro | 05 - | 1 | ● |
| CANNONDALE | | | | | |
| MX | 400 | | 00 - | 1 | ● |
| | 440 | C / E / X | 03 - | 1 | ● |
| CPI | | | | | |
| | 125 | Sahel | 02 - | 1 | ● |
| FANTIC | | | | | |
| MX | 50 | Regolarna Competizione | 08 - | 1 | ● |
| MX | 65 | Regolarna Competizione | 08 - | 1 | ● |
| MX | 80 | Regolarna Competizione | 08 - | 1 | ● |
| MX | 85 | Regolarna Competizione | 08 - | 1 | ● |
| MX | 125 | Regolarna Competizione | 08 - | 1 | ● |
| GAS GAS | | | | | |
| EC | 125 | | 00 - | 1 | ● |
| MC | 125 | | 03 - | 1 | ● |
| EC | 200 | Hobby | 07 - | 1 | ● |
| EC | 200 | | 00 - | 1 | ● |
| EC | 250 | FSE | 02 - | 1 | ● |
| EC | 250 | | 00 - | 1 | ● |
| MC | 250 | | 00 - | 1 | ● |
| EC | 300 | | 00 - | 1 | ● |
| EC | 400 | fse | 02 - | 1 | ● |
| | 400 | Pampera | 06 - | 1 | ● |
| EC | 450 | fse | 03 - | 1 | ● |
| EC | 450 | FSR | 07 - | 1 | ● |
| EC | 500 | fse Enduro | 06 - | 1 | ● |
| EC | 515 | FSR | 08 - | 1 | ● |
| HM | | | | | |
| CR | 125 | X Supermotard | 04 - 06 | 1 | ● |
| CRE | 125 | X Supermotard | 02 - 06 | 1 | ● |
| CRE | 250 | Supermotard | 02 - 03 | 1 | ● |
| CRF | 250 | Supermotard | 04 - 06 | 1 | ● |
| CRF | 450 | R Supermotard | 02 - 06 | 1 | ● |
| CRE | 125 | R Enduro | 95 - 01 | 1 | ● |
| CRE | 125 | Enduro | 02 - 07 | 1 | ● |
| CRF | 230 | Enduro / Trial | 04 - 07 | 1 | ● |
| CRE | 250 | R Enduro | 02 - 07 | 1 | ● |
| CRF | 250 | F | 04 - 08 | 1 | ● |
| CRE | 450 | F | 02 | 1 | ● |
| CRE | 450 | R Enduro | 02 - 07 | 1 | ● |
| CRE | 450 | F / X | 04 - 07 | 1 | ● |
| CRF | 450 | R Enduro | 04 - 08 | 1 | ● |
| CRF | 450 | R | 04 - 08 | 1 | ● |
| CRE | 490 | X | 07 | 1 | ● |
| HONDA | | | | | |
| CRM | 50 | (Spain) | 93 - 96 | 1 | ● |
| XR | 125 | L | 03 - | 1 | ● |
| CRF | 150 | F | 03 - | 1 | ● |
| CTX | 200 | | 04 - | 1 | ● |
| SL | 230 | | 97 - | 1 | ● |
| XLR | 250 | R SPL | 94 - | 1 | ● |
| XR | 400 | Supermotard | 00 - | 1 | ● |
| XL | 600 | V Transalp | 97 - 99 | 2 | ● |
| XL | 650 | V Transalp | 00 - | 2 | ● |
| XR | 750 | Africa Twin | 93 - 03 | 2 | ● |

HONDA

| | | | | | |
|-----|-----|-------|---------|---|---|
| CR | 125 | R | 95 - 01 | 1 | ● |
| CR | 125 | R | 02 - | 1 | ● |
| CRE | 125 | | 02 - | 1 | ● |
| CRF | 230 | | 04 - | 1 | ● |
| CR | 250 | R | 95 - 01 | 1 | ● |
| CR | 250 | R | 02 - | 1 | ● |
| CRE | 250 | | 02 - 03 | 1 | ● |
| CRE | 250 | F | 04 - | 1 | ● |
| CRF | 250 | R Efi | 04 - 09 | 1 | ● |
| CRF | 250 | X | 04 - 09 | 1 | ● |
| XR | 250 | L | 93 - 96 | 1 | ● |
| XR | 250 | R | 96 - 04 | 1 | ● |
| XR | 400 | R | 96 - | 1 | ● |
| XR | 440 | R | 00 - | 1 | ● |
| CRE | 450 | F | 02 - | 1 | ● |
| CRF | 450 | R | 02 - 08 | 1 | ● |
| CRF | 450 | R Efi | 09 - | 1 | ● |
| CRF | 450 | X | 05 - | 1 | ● |
| CR | 500 | R | 95 - 01 | 1 | ● |
| XR | 600 | R | 93 - 00 | 1 | ● |
| XR | 650 | L | 93 - | 1 | ● |
| XR | 650 | R | 00 - | 1 | ● |
| TRX | 450 | R | 04 - | 2 | ● |
| TRX | 700 | XX | 08 - | 2 | ● |

KAWASAKI

| | | | | | |
|------|-----|-------------------|---------|---|---|
| KLX | 250 | R | 93 - 94 | 1 | ● |
| KLX | 250 | ES | 94 - 97 | 1 | ● |
| KLX | 250 | | 98 - 03 | 1 | ● |
| KLX | 250 | S | 06 - 07 | 1 | ● |
| KLX | 650 | A1-A3 / C1-C4 | 93 - 96 | 1 | ● |
| KLX | 650 | R | 93 - 95 | 1 | ● |
| KX | 125 | K1 | 94 | 1 | ● |
| KX | 125 | | 95 - | 1 | ● |
| KDX | 200 | E6 / H1 / H2 / H3 | 94 - 99 | 1 | ● |
| KDX | 220 | R A4 | 97 - | 1 | ● |
| KLX | 250 | D1-D4 / ES | 93 - 96 | 1 | ● |
| KX | 250 | K1 | 94 | 1 | ● |
| KX | 250 | | 95 - | 1 | ● |
| KLX | 250 | | 98 - 07 | 1 | ● |
| KX-F | 250 | | 04 - | 1 | ● |
| KLX | 300 | R A2 | 97 - | 1 | ● |
| KLX | 400 | R / SR | 03 - | 1 | ● |
| KLX | 450 | R | 07 - | 1 | ● |
| KX-F | 450 | | 06 - 08 | 1 | ● |
| KX-F | 450 | Efi | 09 - | 1 | ● |
| KX | 500 | E6 / E7 | 94 - 95 | 1 | ● |
| KX | 500 | E8 / E9 | 96 - | 1 | ● |
| KLX | 650 | R | 93 - 95 | 1 | ● |
| KLX | 650 | R D1 | 96 | 1 | ● |

SUZUKI

| | | | | | |
|------|-----|--------------------------------|---------|---|---|
| DR | 125 | SM | 08 - 10 | 1 | ● |
| DR | 250 | RS/RLS/RT/RLV/RLW (SJ45A) DOHC | 90 - 95 | 1 | ● |
| DR | 250 | RXT/RXLT/RXV/Djebel XC (SJ45A) | 96 - 98 | 1 | ● |
| DR | 350 | SEW/SEX | 98 - 99 | 1 | ● |
| DR-Z | 400 | SM | 05 - 09 | 1 | ● |
| DR | 650 | SE (SP46A/B) | 96 - 97 | 1 | ● |
| RM | 125 | T/V/W/X/Y K1-K5 | 96 - 05 | 1 | ● |
| RM | 125 | K6 - K9 | 06 - 09 | 1 | ● |
| RM | 125 | K10 | 10 - | 1 | ● |
| RM-E | 125 | | 05 - | 1 | ● |
| DR-Z | 250 | K1 / K7 | 01 - 07 | 1 | ● |
| RM | 250 | T/V/W/X/Y K1-K5 | 96 - 05 | 1 | ● |
| RM | 250 | K6 - K9 | 06 - 09 | 1 | ● |
| RM | 250 | K10 | 10 - | 1 | ● |
| RME | 250 | | 05 - | 1 | ● |
| RMX | 250 | T / V / W | 96 - 98 | 1 | ● |
| RM-Z | 250 | E | 04 - 09 | 1 | ● |
| RM-Z | 250 | Efi | 10 - | 1 | ● |
| DR-Z | 400 | E / S | 00 - 08 | 1 | ● |
| RM-X | 450 | | 05 - | 1 | ● |
| RM-Z | 450 | | 05 - 07 | 1 | ● |
| RM-Z | 450 | Efi | 08 - | 1 | ● |

YAMAHA

| | | | | | |
|----|-----|------------------------|---------|---|---|
| WR | 250 | R | 08 - | 1 | ● |
| WR | 125 | | 98 - 02 | 1 | ● |
| YZ | 125 | K / L / M / N / P | 98 - 02 | 1 | ● |
| YZ | 125 | R / S / T / V / W | 03 - 07 | 1 | ● |
| WR | 250 | ZK/FN/FP | 98 - 02 | 1 | ● |
| WR | 250 | FR/FS/FT/FV | 03 - 06 | 1 | ● |
| WR | 250 | FW/FX/FY/FZ | 07 - | 1 | ● |
| YZ | 250 | K / L / M (2T) | 98 - 00 | 1 | ● |
| YZ | 250 | N / P (2T) | 01 - 02 | 1 | ● |
| YZ | 250 | FN / FP (4T) | 01 - 02 | 1 | ● |
| YZ | 250 | R / S / T / V / W (2T) | 03 - 07 | 1 | ● |
| YZ | 250 | FR / FS / FT / FV (4T) | 03 - 06 | 1 | ● |
| WR | 400 | FK (4T) | 98 | 1 | ● |
| WR | 400 | FL / FM / FN (4T) | 99 - 01 | 1 | ● |
| YZ | 400 | FK (4T) | 98 | 1 | ● |
| YZ | 400 | FL (4T) | 99 | 1 | ● |
| WR | 426 | FN / FP (4T) | 00 - 02 | 1 | ● |
| YZ | 426 | FM / FN / FP (4T) | 00 - 02 | 1 | ● |
| WR | 450 | FR / FS / FT / FV (4T) | 03 - 06 | 1 | ● |
| WR | 450 | FW / FX / FY / FZ (4T) | 07 - | 1 | ● |
| YZ | 450 | FR / FS / FT / FV (4T) | 03 - 06 | 1 | ● |
| YZ | 450 | FW (4T) | 07 | 1 | ● |

Street Sport Racing Enduro MX Off Road Racing ATV

S4 A3+ RX3

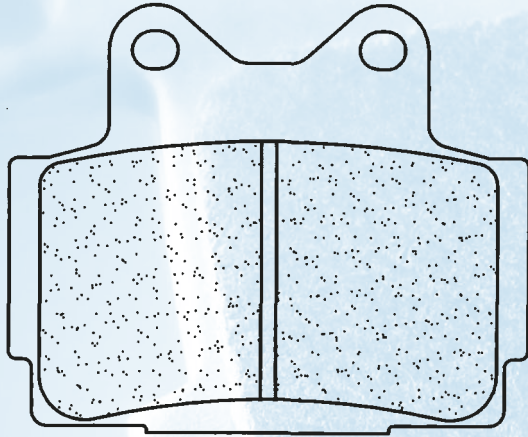

Dim./Size

68 mm

56,5 mm

9 mm

2301

YAMAHA

| | | | | | |
|-----|-----|---------------|---------|---|---|
| FZR | 50 | | 90 - 91 | | ● |
| TZR | 80 | | - 91 | 1 | ● |
| RD | 125 | LC | 85 - 87 | 1 | ● |
| RZ | 125 | (1GV 030101-) | 85 - | 1 | ● |
| TZR | 125 | (2RK / 3PC1) | 87 - 89 | 1 | ● |
| TZR | 125 | (3PC2 / 3PC3) | 90 - 92 | | ● |

YAMAHA

| | | | | | |
|------|-----|-------------------------|---------|---|---|
| TZR | 125 | (3JB / 4JB / 4HW / 4HX) | 93 - 95 | | ● |
| TZR | 150 | (4AP2) | 00 - | | ● |
| SDR | 200 | | 87 - 89 | 1 | ● |
| RZ | 250 | R (1AR/1XG) | 80 - | 2 | ● |
| RZ | 250 | RR (5IL) | 88 - | 2 | ● |
| SRX | 250 | T / TC | 84 - 87 | 1 | ● |
| FZR | 250 | | 87 - 88 | | ● |
| FZR | 250 | R | 89 - | | ● |
| FZX | 250 | Zeal | 91 - 92 | | ● |
| R1-Z | 250 | | 90 - | | ● |
| RZ | 250 | R (29L) | 80 - | | ● |
| TDR | 250 | | 88 - 92 | | ● |
| TZR | 250 | | 87 - 92 | | ● |
| TZR | 250 | / SP / R / RS / SPR | 89 - 96 | | ● |
| RD | 350 | N / F / F2 | 85 - 92 | 2 | ● |
| RD | 350 | R | 92 - 95 | 2 | ● |
| RZ | 350 | F | 86 - 88 | 2 | ● |
| FZ | 400 | N | 85 | | ● |
| FZ | 400 | R | 86 - 87 | | ● |
| FZR | 400 | Genesis (1WG) | 86 | | ● |
| FZR | 400 | R SP (2TK-Exup) | 87 | | ● |
| FZR | 400 | (3EN1) | 88 | | ● |
| FZR | 400 | R (3EN2) | 89 | | ● |
| FZR | 400 | RR (3TJ1 / 4DX) | 89 - 92 | | ● |
| FZR | 400 | RR SP (3TJ1 / 4DX) | 91 - 94 | | ● |
| SRX | 400 | (1JL) | 85 - 86 | | ● |
| SRX | 400 | (3VN) | 90 - 96 | | ● |
| XJ | 400 | S Diversion | 91 - | | ● |
| XJR | 400 | R | 93 - 96 | | ● |
| XJR | 400 | R (Brembo calipers) | 95 - 99 | | ● |
| RD | 500 | LC (RVZ500R) | 84 - 86 | | ● |
| RZ | 500 | | 84 - 86 | | ● |
| SRX | 600 | (1JK) | 85 - 87 | 2 | ● |
| FZ | 600 | | 87 - 88 | | ● |
| FZS | 600 | Fazer | 98 - 03 | | ● |
| SRX | 600 | (3SX) | 90 | | ● |
| XJ | 600 | N / S Diversion | 92 - 97 | | ● |
| XJ | 600 | N / S Diversion | 98 - 03 | | ● |

Street Sport Racing Enduro MX Off Road Racing ATV

S4 A3+

MX10

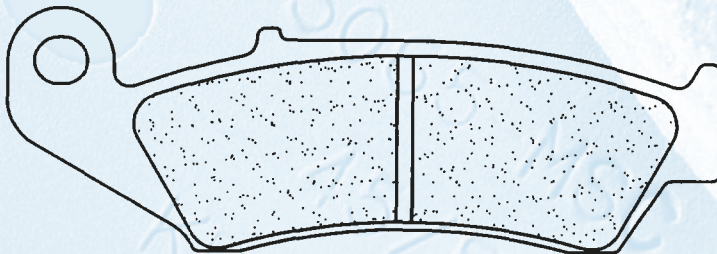

Dim./Size

94 mm

32 mm

7,4 mm

2302

HONDA

| | | | | | |
|------|-----|--------------|---------|---|---|
| CRM | 75 | R | 90 - 94 | 1 | ● |
| AX-1 | 250 | | 90 | 1 | ● |
| CRM | 250 | R | 90 - | 1 | ● |
| NX | 250 | | 88 - 90 | 1 | ● |
| XL | 250 | Degree | 91 - | 1 | ● |
| XLR | 250 | R Baja | 88 - 90 | 1 | ● |
| CR | 125 | RH / RJ / RK | 87 - 94 | 1 | ● |
| CR | 250 | / R | 87 - 94 | 1 | ● |
| XR | 250 | L | 91 - 92 | 1 | ● |
| XR | 250 | R | 88 - 89 | 1 | ● |
| XR | 250 | R | 90 - 95 | 1 | ● |

HONDA

| | | | | | |
|-----|-----|---|---------|---|---|
| ATC | 300 | X | 86 - | 1 | ● |
| CR | 500 | R | 87 - 94 | 1 | ● |
| XR | 600 | R | 88 - 90 | 1 | ● |
| XR | 600 | R | 91 - 92 | 1 | ● |

Street Sport Racing Enduro MX Off Road Racing ATV

S4 A3+ RX3

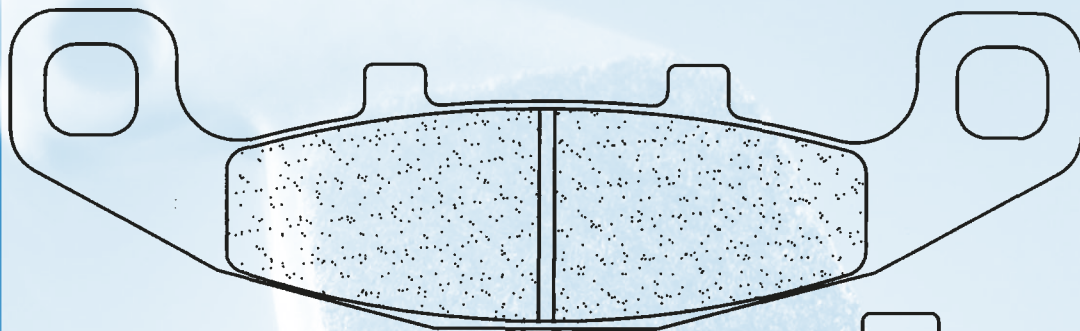

Dim./Size
 → 141 mm
 ↓ 41,8 mm
 H 8,5 mm

2304

Dim./Size
 → 95,2 mm
 ↓ 34,7 mm
 H 9 mm

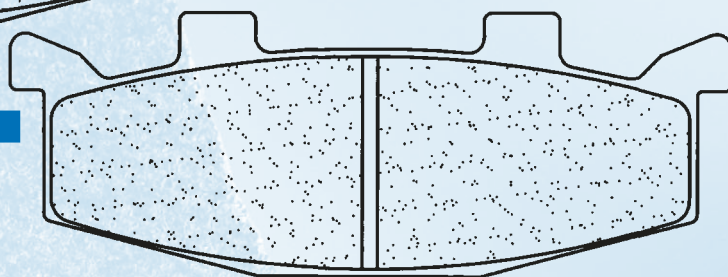

HYOSUNG

| | | | | | |
|----|-----|-------|----|---|---|
| GT | 250 | Comet | 02 | 1 | ● |
| GT | 600 | Comet | 02 | 1 | ● |

KAWASAKI

| | | | | | |
|------|-----|---------------------------|---------|---|-----|
| EX | 250 | R F2-F17 Ninja | 88 - 07 | 1 | ● |
| GPX | 250 | R | 88 - | 2 | ● |
| ZR | 250 | Balius | 91 - 95 | 1 | ● |
| ZZR | 250 | | 90 - 01 | 1 | ● |
| | 400 | Eliminator | 94 - | 1 | ● |
| GPZ | 400 | S | 88 - | 1 | ● |
| KLE | 400 | | 91 - | 1 | ● |
| ER-5 | 500 | | 97 - 00 | 1 | ● |
| EX | 500 | A1-A3 | 87 - 89 | 1 | ● |
| EX | 500 | A4-A7 | 90 - 93 | 1 | ● |
| EX | 500 | D1-D3 Ninja | 94 - 96 | 1 | ● |
| GPX | 500 | R (Austria) | 88 | 2 | ● ● |
| GPZ | 500 | S A1-A6 | 87 - 93 | 1 | ● |
| GPZ | 500 | S D1-D7 | 94 - 01 | 1 | ● |
| KL | 500 | Tengai (Austria) | 89 - 91 | 1 | ● |
| KLE | 500 | A1-A4 | 91 - | 1 | ● |
| ZR | 550 | B1 / B3 / Zephyr | 90 - 92 | 2 | ● |
| ZR | 550 | B4 / B5 / Zephyr | 93 - 99 | 2 | ● |
| GPX | 600 | R | 88 - 93 | 2 | ● ● |
| GPX | 600 | R | 94 - | 2 | ● ● |
| GPZ | 600 | R | 94 - | 2 | ● ● |
| ZL | 600 | B2 Eliminator | 95 - 98 | 1 | ● |
| ZX | 600 | C1-C9 Ninja R | 88 - 97 | 2 | ● ● |
| KL | 650 | B1 / B2 / B3 Tengai (KLR) | 89 - 91 | 1 | ● |

KAWASAKI

| | | | | | | |
|-------|------|-----------|---------|---|---|---|
| GPX | 750 | R | 87 - | 2 | ● | ● |
| ZR | 750 | Zephyr | 91 - 95 | 2 | ● | ● |
| GTR | 1000 | | 94 - 06 | 2 | ● | ● |
| ZX10 | 1000 | B2 / B3 | 88 - 90 | 2 | ● | ● |
| GPX | 400 | | 87 - | | ● | ● |
| GPZ | 400 | R | 89 - | | ● | ● |
| ZZR | 400 | | 90 - 94 | | ● | ● |
| ZZR | 500 | (Austria) | 90 - 92 | | ● | ● |
| ZX6-R | 600 | D1-D4 | 90 - 93 | | ● | ● |
| ZZR | 600 | | 90 - 92 | | ● | ● |
| ZR | 750 | Zephyr | 96 - 98 | | ● | ● |
| GPZ | 900 | R | 90 - | | ● | ● |
| ZR | 1100 | Zephyr | 92 - 96 | | ● | ● |
| ZR | 1100 | Zephyr | 97 - | | ● | ● |
| ZZR | 1100 | | 90 - 93 | | ● | ● |

SUZUKI

| | | | | | |
|-----|------|-------------------|---------|---|---|
| RG | 125 | Wolf | 92 - 94 | 1 | ● |
| TV | 200 | Wolf | 92 - | 1 | ● |
| GSF | 250 | Bandit | 90 - 96 | 1 | ● |
| GSX | 250 | F - Across | 90 - 98 | 1 | ● |
| GSX | 250 | S Katana | 91 - | 1 | ● |
| SW1 | 250 | | 92 - | 1 | ● |
| GSF | 400 | Bandit M/N/P | 91 - 95 | 1 | ● |
| GS | 500 | E | 89 - 95 | 1 | ● |
| DR | 800 | SM (SR43A) Big | 91 - 95 | 1 | ● |
| VX | 800 | L / M / N / P / R | 90 - 96 | 1 | ● |
| GSX | 1100 | GM / GN / GP | 91 - 93 | 2 | ● |
| GSX | 1100 | G | 94 - 95 | 2 | ● |



Street Sport Racing Enduro MX Off Road Racing ATV

S4 A3+ RX3 XBK5 C59

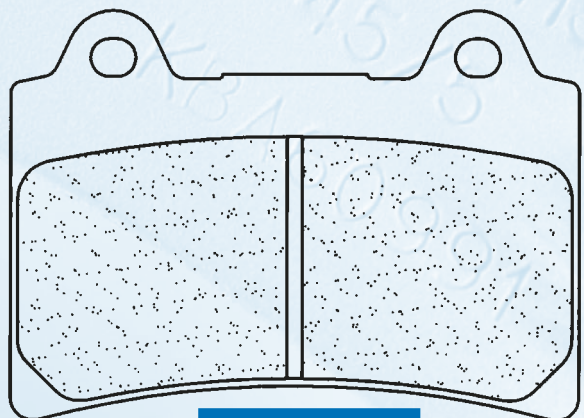

Dim./Size
 → 74,9 mm
 ↓ 54 mm
 H 10 mm

YAMAHA

| | | | | | |
|-----|------|-----------------------------|---------|---|---|
| FZR | 250 | | 87 - 88 | 2 | ● |
| TDR | 250 | | 88 - 92 | 1 | ● |
| TZR | 250 | | 87 - 92 | 2 | ● |
| FZR | 400 | R SP (2TK-Exup) | 87 | 2 | ● |
| FZR | 400 | (3EN1) | 88 | 2 | ● |
| FZR | 400 | R (3EN2) | 89 | 2 | ● |
| SRX | 400 | (3VN) | 90 - 96 | 1 | ● |
| SRX | 600 | (3SX) | 90 | 1 | ● |
| FZ | 750 | | 89 - 91 | 2 | ● |
| FZR | 750 | R Genesis | 87 - 88 | 2 | ● |
| TDM | 850 | | 91 - 95 | 2 | ● |
| TRX | 850 | | 96 - 99 | 2 | ● |
| FZR | 1000 | Genesis | 87 - 89 | 2 | ● |
| FJ | 1200 | (3CV/CXW Type) | 88 - 95 | 2 | ● |
| XJR | 1200 | / SP | 95 - 98 | 2 | ● |
| XVZ | 1300 | A Royal Star / Tour Classic | 96 - 01 | | ● |
| XVZ | 1300 | TF Venture Star | 99 - 01 | | ● |
| XVZ | 1300 | Venture Royale | 86 - 89 | | ● |
| XVZ | 1300 | Venture Royale | 90 - 95 | | ● |
| XV | 1600 | A Wild Star | 99 - 04 | | ● |

2305

| | | | | | | |
|--------|-------|--------|--------|------|-----------------|------|
| Street | Sport | Racing | Enduro | MX | Off Road Racing | ATV |
| S4 | A3+ | RX3 | EN10 | MX10 | X59 | ATV1 |

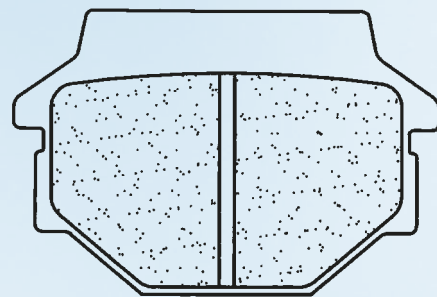
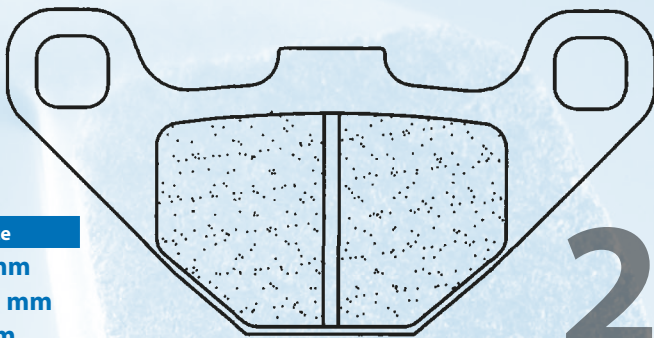

| Dim./Size | |
|-----------|---------|
| → | 85 mm |
| ↑ | 42,5 mm |
| H | 8 mm |

| Dim./Size | |
|-----------|---------|
| → | 56 mm |
| ↑ | 37,1 mm |
| H | 10 mm |

2306

APRILIA

| | | | |
|-----|-------------|---------|---|
| 125 | Pegaso | 90 - 91 | ● |
| 125 | Tuareg Wind | 90 - | ● |
| RX | 125 | 92 - 07 | ● |
| 350 | Tuareg Wind | 90 - | ● |
| 600 | Tuareg | 88 - | ● |
| 600 | Tuareg Wind | 90 - | ● |
| 650 | Moto 6.5 | 95 - | ● |
| 650 | Pegaso | 97 - 00 | ● |
| RX | 125 | 90 - 96 | ● |
| RX | 125 | 97 - | ● |

BATAVUS

| | | | | |
|--|------------|------|---|---|
| | Grand prix | 80 - | 1 | ● |
|--|------------|------|---|---|

BUELL

| | | | |
|--|------------|---------|---|
| | All models | 94 - 97 | ● |
|--|------------|---------|---|

RS

| | | | |
|------|--|--|---|
| 1200 | | | ● |
|------|--|--|---|

CAGIVA

| | | | |
|-----|-------|---------|---|
| 600 | W16 | 95 - | ● |
| 125 | Cross | 86 - | ● |
| WMX | 125 | 89 - 90 | ● |
| WMX | 250 | 89 - 90 | ● |

DERBI

| | | | | |
|-----|-----|-------------------|------|---|
| DXR | 200 | Quad (front disc) | 04 - | ● |
| DXR | 200 | Quad (front drum) | 04 - | ● |
| DXR | 250 | Quad (front disc) | 04 - | ● |
| DXR | 250 | Quad (front drum) | 04 - | ● |

FANTIC

| | | | | |
|-----|----------|------|---|---|
| 50 | 1 Raider | 87 - | 1 | ● |
| 50 | Strada | 83 | 1 | ● |
| 50 | Extra SM | 98 - | | ● |
| 125 | Extra SM | 98 - | | ● |

HUSABERG

| | | | |
|-----|------------|---------|---|
| | All models | 89 - 92 | ● |
| 350 | | 91 - | ● |
| 500 | Enduro | | ● |

HUSQVARNA

| | | | | |
|-----|-----|---------|---------|---|
| CR | 125 | 91 - 95 | ● | |
| WR | 125 | 91 - 96 | ● | |
| WRK | 125 | 90 | ● | |
| WR | 240 | 91 - | ● | |
| WRK | 240 | 90 | ● | |
| WR | 250 | 90 - 96 | ● | |
| CR | 250 | 91 - 96 | ● | |
| WR | 260 | 90 - | ● | |
| TE | 350 | Enduro | 90 | ● |
| WR | 360 | | 96 | ● |
| TE | 410 | | 96 | ● |
| TE | 510 | | 90 - | ● |
| TC | 610 | Cross | 91 - 96 | ● |
| TE | 610 | | 91 - 96 | ● |

KAWASAKI

| | | | | | |
|-----|----------|------------------|---------|---|---|
| KH | 100 | EX | 88 - | 1 | ● |
| KH | 100 | GH | 83 - | 1 | ● |
| AR | 125 | A1/A1A / A7 / LC | 82 - 94 | 1 | ● |
| KE | 125 | | 86 - | 1 | ● |
| KH | 125 | | 82 - 98 | 1 | ● |
| Z | 200 | A6 | 83 - | 1 | ● |
| 250 | Estrella | 92 - | 1 | ● | ● |
| GPZ | 250 | Belt Drive | 83 - 84 | 1 | ● |
| KL | 250 | D2-D14 (KLR 250) | 85 - 97 | 1 | ● |
| KL | 250 | D12 / D13 | 95 - 96 | 1 | ● |
| KR | 250 | | - 85 | 2 | ● |
| Z | 250 | T Scorpion | 89 - | 1 | ● |
| GPZ | 305 | | 81 - 96 | 2 | ● |
| FX | 400 | R | 86 - 88 | 2 | ● |
| GPZ | 400 | | 85 - 87 | 2 | ● |
| LX | 400 | Eliminator / SE | 90 | 2 | ● |
| Z | 400 | F | 84 - | 1 | ● |
| ZR | 400 | F / A1 | 83 - 84 | 1 | ● |
| ZX | 400 | | 85 | 1 | ● |
| GPZ | 500 | S B1-B5 | 88 - 93 | 2 | ● |

KAWASAKI

| | | | | | |
|-----|-----|---------------------------|---------|---|---|
| ZR | 500 | A1 | 83 - | 1 | ● |
| KX | 550 | A | 83 - | 1 | ● |
| Z | 550 | F | 83 - 84 | 2 | ● |
| Z | 550 | GT | 83 - | 2 | ● |
| ZR | 550 | A1 / GP | 83 - | 2 | ● |
| KL | 600 | A1 / B1 / B2 | 84 - 86 | 1 | ● |
| KLR | 600 | | 84 - 86 | 1 | ● |
| KLR | 600 | E | 85 - 94 | 1 | ● |
| KX | 125 | B2 / C1 / D1 | 83 - 85 | 1 | ● |
| KX | 125 | E1 | 86 | 1 | ● |
| KDX | 200 | C | 86 - 88 | 1 | ● |
| KDX | 200 | SR / E1 / E4 | 89 - 92 | 1 | ● |
| KX | 250 | C1 / C2 / D1 | 83 - 85 | 1 | ● |
| KX | 250 | D2 | 86 | 1 | ● |
| KLR | 350 | | 85 - | 1 | ● |
| KX | 500 | A1 / A2 / B1 | 83 - 85 | 1 | ● |
| KX | 500 | B2 | 86 | 1 | ● |
| KXT | 250 | A2 / B1 Tecate Trike | 85 - 86 | 1 | ● |
| KLF | 300 | B1-B13 Bayou | 88 - | 2 | ● |
| KMX | 125 | | 86 | | ● |
| KMX | 125 | | 87 - 02 | | ● |
| KMX | 200 | A2 / A3 / A4 | 88 - 92 | | ● |
| ZR | 250 | Balius | 91 - 95 | | ● |
| ZZR | 250 | | 90 - 01 | | ● |
| KLE | 400 | | 91 - | | ● |
| ZR | 400 | Xanthus (D1) | 92 - 95 | | ● |
| EX | 500 | D1-D3 Ninja | 94 - 96 | | ● |
| EX | 500 | E1-E3 | 94 - 96 | | ● |
| GPZ | 500 | S D1-D7 | 94 - 01 | | ● |
| GPZ | 500 | S E1-E10 | 94 - 04 | | ● |
| KL | 500 | Tengai (Austria) | 89 - 91 | | ● |
| KLE | 500 | A1-A4 | 91 - | | ● |
| KLR | 500 | (Austria) | 87 - 88 | | ● |
| KL | 650 | B1 / B2 / B3 Tengai (KLR) | 89 - 91 | | ● |
| KL | 650 | C1 (KLR) | 95 - | | ● |
| KLR | 650 | A1-A11 | 87 - 97 | | ● |
| KLR | 650 | C1 | 98 - | | ● |
| KX | 125 | E2 / F1 | 87 - 88 | | ● |
| KMX | 125 | | 86 | | ● |
| KMX | 125 | | 87 - 02 | | ● |
| KL | 250 | Super Sherpa | 98 - | | ● |
| KX | 250 | E1 / F1 | 87 - 88 | | ● |
| KX | 500 | C1 / D1 | 87 - 88 | | ● |

KEEWAY

| | | | | |
|-----|-------|------|---|---|
| 125 | Speed | 06 - | 1 | ● |
| 150 | Speed | 06 - | 1 | ● |

KRAM IT

| | | | | |
|----|-----|--|---------|---|
| ER | 125 | | 89 - 93 | ● |
| MC | 250 | | 89 | ● |
| ER | 300 | | 89 | ● |

KTM

| | | | | | |
|----------------------------|-----------------------|--------------------------|---------|---|---|
| GS | 125 | | 89 - 90 | 1 | ● |
| MX | 125 | | 89 - 90 | 1 | ● |
| GS | 250 | | 89 - 90 | 1 | ● |
| MX | 250 | | 89 - 90 | 1 | ● |
| MX | 300 | | 90 | 1 | ● |
| LC4 | 350 | | 92 - | 1 | ● |
| MX | 500 | | 89 - 91 | 1 | ● |
| MX | 125 / 250 / 300 / 500 | | 89 - 91 | 1 | ● |
| GS | 125 | | 92 - | | ● |
| MX | 125 | | 92 - 93 | | ● |
| MX | 250 | | 92 - 93 | | ● |
| EXC | 300 | | 93 - 96 | | ● |
| MX | 300 | | 92 - | | ● |
| LC4 | 400 | | 93 - 98 | | ● |
| MX | 500 | | 92 - 93 | | ● |
| LC4 | 600 | Six Days | 92 - | | ● |
| MXC125/ 250/ 300/ 500/ 550 | | | 92 - 93 | | ● |
| | | GS / EXC / Enduro models | 91 | | ● |

LAVERDA

| | | | | |
|-----|--------|------|---|---|
| 700 | El Cid | 90 - | 2 | ● |
|-----|--------|------|---|---|

| Street | Sport | Racing | Enduro | MX | Off Road Racing | ATV |
|--------|-------|--------|--------|------|-----------------|------|
| S4 | A3+ | RX3 | EN10 | MX10 | X59 | ATV1 |

2306 suite

| MAICO | | | | | | |
|------------|-------------------------------|-----------------------|---------|---|---|---|
| All Models | | 91 | | | | ● |
| POLARIS | | | | | | |
| 200 | Phoenix | 05 - 08 | | | | ● |
| RIEJU | | | | | | |
| 125 | Marathon Pro Supermotard | 09 - 10 | | | | ● |
| 125 | Marathon Pro (Radial Caliper) | 09 - 10 | | | | ● |
| 125 | NKD | 08 - 10 | | | | ● |
| 125 | RS2 (J.Juan Caliper) | 07 - 10 | | | | ● |
| 125 | RS2 Pro (J.Juan Caliper) | 07 - 10 | | | | ● |
| 125 | Tango Motard (Cast Wheel) | 08 - 09 | | | | ● |
| SUZUKI | | | | | | |
| GSX-R | 50 | 87 - | 1 | ● | | |
| OR | 50 | E | 80 - | 1 | ● | |
| RB | 50 | H | 87 | 1 | ● | |
| RG | 50 | GAG | 87 - | 1 | ● | |
| RG | 50 | Gamma | 90 - | 1 | ● | |
| TV | 50 | Wolf | 89 - | 1 | ● | |
| ZR | 50 | SAPX / SKX / SLK | 81 - 87 | 1 | ● | |
| GT | 80 | L/C | 81 - | 1 | ● | |
| RG | 80 | Gamma | - 87 | 1 | ● | |
| TRS | 118 | | 82 - 83 | 1 | ● | |
| GN | 125 | EM-T | 91 - 04 | 1 | ● | |
| GS | 125 | ESZ | 82 | 1 | ● | |
| GS | 125 | ESD / ESF / ESK / ESM | 83 - 94 | 1 | ● | |

| SUZUKI | | | | | | |
|--------|-------------------|----------------------|---------|---|---|--|
| GS | 125 | ESR / ESX | 95 - 00 | 1 | ● | |
| GT | 125 | T / ET | 80 - | 1 | ● | |
| TR | 125 | | 83 - | 1 | ● | |
| X4 | 125 | / X3E | 81 - | 1 | ● | |
| ET | 240 | | 86 - | 1 | ● | |
| NZ | 250 | S | 86 - | 1 | ● | |
| GSX | 400 | FX / FZ | 81 - 83 | 2 | ● | |
| GS | 450 | E | 90 - | 1 | ● | |
| GS | 450 | S | 86 | 1 | ● | |
| GSX | 250 | FX | 02 - 05 | | ● | |
| TGB | | | | | | |
| 250 | Blade / Congo | 06 - 07 | 2 | ● | | |
| 325 | Blade 4x2 / LE | 07 - | 2 | ● | | |
| 325 | Target 4x2 | 09 - | | ● | | |
| 400 | Target 4x2 | 09 - | | ● | | |
| 425 | Target 4x2 | 09 - | | ● | | |
| 500 | Target 4x2 | 09 - | | ● | | |
| 525 | Blade 4x4 SL | 09 - | | ● | | |
| 525 | SE 4x4 | 09 - | | ● | | |
| 525 | Target 4x4 | 09 - | | ● | | |
| 550 | Blade 4x4 SE / SL | 09 - | | ● | | |
| YAMAHA | | | | | | |
| TDR | 125 | (3HS1/3XD03SH3/3XD1) | 89 - 93 | | ● | |

| Street | Sport | Racing | Enduro | MX | Off Road Racing | ATV |
|--------|-------|--------|--------|----|-----------------|-----|
| A3+ | XBK5 | | | | | |

| BERINGER | | | | | |
|----------|-----------------------|---|---|--|--|
| 2 | Piston Caliper - Road | 1 | ● | | |
| 6 | Piston Caliper - Road | 3 | ● | | |
| BREMBO | | | | | |
| P 30 A | - Road | 1 | ● | | |

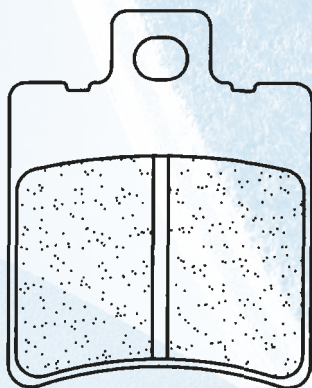

Dim./Size
 — 39,7 mm
 ↑ 49,5 mm
 H 6 mm

2307

| Street | Sport | Racing | Enduro | MX | Off Road Racing | ATV |
|--------|-------|--------|--------|----|-----------------|-----|
| A3+ | | | | | | |

| SUZUKI | | | | | |
|--------|-----|------------------------|---------|---|---|
| DR | 650 | R (SP41A) / RS (SP42A) | 90 - 91 | 1 | ● |
| DR | 650 | RSE (SP43A) | 91 - 95 | 1 | ● |
| DR | 650 | R (SP44A/B) | 92 - 93 | 1 | ● |
| DR | 750 | SJ Big | 88 | 1 | ● |
| DR | 750 | SK Big | 89 - 90 | 1 | ● |
| DR | 800 | SL (SR43A) Big | 90 | 1 | ● |
| DR-Z | 800 | Paris Dakar | 88 - 90 | 1 | ● |

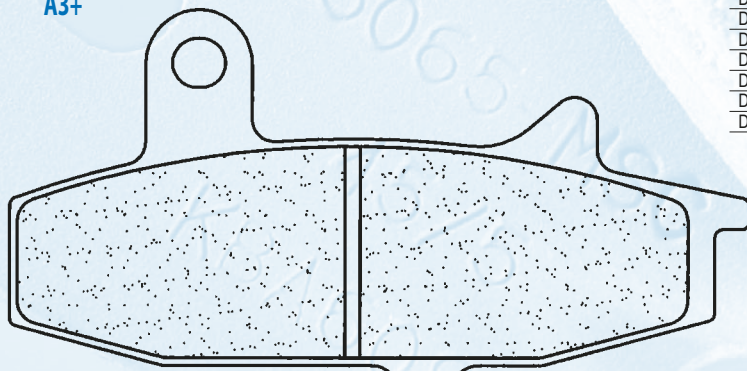

Dim./Size
 — 97,5 mm
 ↑ 58 mm
 H 10 mm

2308

Dim./Size
 — 117 mm
 ↑ 48 mm
 H 9 mm

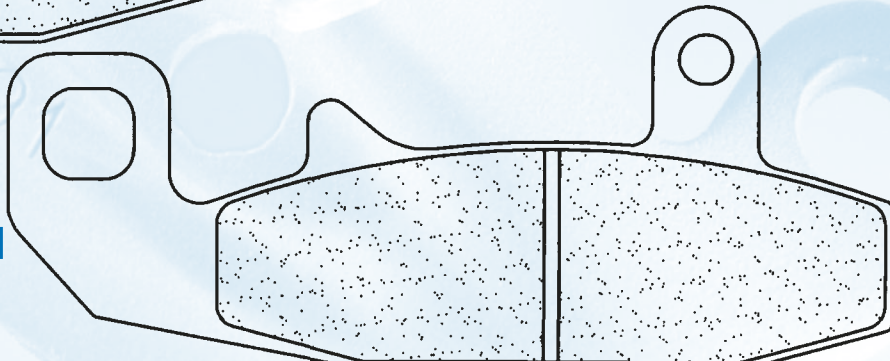

Street Sport Racing Enduro MX Off Road Racing ATV

A3+ XBK5

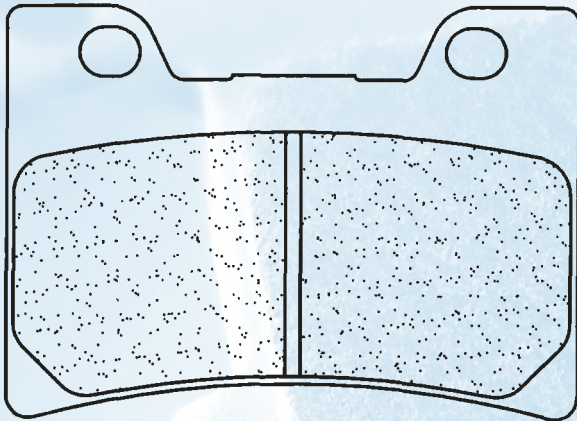

| | | | | | |
|--------|------|------|---------|---|---|
| YAMAHA | | | | | |
| FZR | 1000 | EXUP | 91 - 93 | 2 | ● |

2309

Dim./Size

→ 75 mm
↑ 54 mm
H 10 mm

Street Sport Racing Enduro MX Off Road Racing ATV

A3+

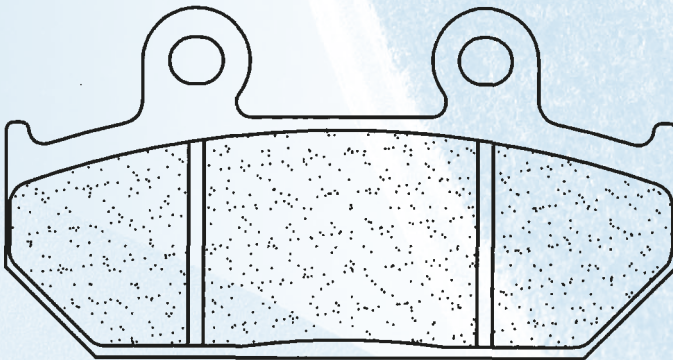

| | | | | | |
|--------|---------|---------------------|---------|---|---|
| CAGIVA | | | | | |
| 750 | Elefant | | 94 - 95 | 1 | ● |
| HONDA | | | | | |
| CB | 250 | | 88 - 91 | 1 | ● |
| CD | 250 | UJ | 88 - 92 | 1 | ● |
| NV | 400 | Steed | 88 | 1 | ● |
| NX | 500 | Dominator (Austria) | 93 - 96 | 1 | ● |
| | 600 | Steed | 88 - 91 | 1 | ● |
| NV | 600 | C | 88 - | 1 | ● |
| NX | 650 | Dominator | 93 - 96 | 1 | ● |
| VFR | 700 | F / F2 | 86 - 87 | 2 | ● |
| CBR | 750 | Hurricane | 87 - | 2 | ● |
| VFR | 750 | F | 86 - 87 | 2 | ● |
| CBR | 1000 | F | 87 - 88 | 2 | ● |

Dim./Size

→ 88 mm
↑ 46,1 mm
H 8,4 mm

2310

Street Sport Racing Enduro MX Off Road Racing ATV

A3+ XBK5

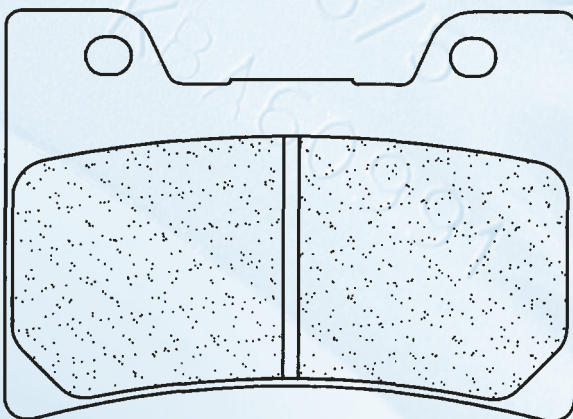

| | | | | | |
|--------|------|-------|---------|---|---|
| YAMAHA | | | | | |
| FZR | 600 | / R | 90 - 95 | 2 | ● |
| TDM | 850 | | 96 - 01 | 2 | ● |
| FZR | 1000 | EXUP | 89 - 90 | 2 | ● |
| FJ | 1200 | A ABS | 91 - 95 | 2 | ● |
| XV | 1200 | V-Max | 93 - 01 | 2 | ● |

2311

Dim./Size

→ 75 mm
↑ 54 mm
H 10 mm

Street Sport Racing Enduro MX Off Road Racing ATV

S4 A3+ RX3

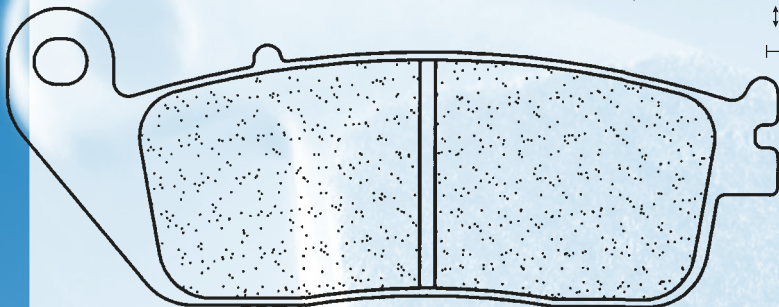

Dim./Size

102 mm
40 mm
9,8 mm

2313

DAELIM

| | | | | |
|-----|---------------|---------|---|---|
| 125 | Magna | 97 - | 1 | ● |
| 125 | Roadwin | 04 - | 1 | ● |
| 125 | Rocket | 99 - | 1 | ● |
| VL | 125 Daystar | 00 - | 1 | ● |
| VT | 125 Evolution | 00 - 01 | 1 | ● |
| 250 | Roadwin | 08 - | 1 | ● |

HONDA

| | | | | | |
|-------|-----|-------------------|---------|---|---|
| VTR | 250 | | 98 - | 1 | ● |
| CB | 400 | Super Four | 92 - 95 | 2 | ● |
| VRX | 400 | T Roadstar | 95 - | 1 | ● |
| XL | 600 | V Transalp | 94 - 96 | 1 | ● |
| NTV | 650 | | 94 - | 2 | ● |
| VF | 750 | C CD Magna | 94 - | 1 | ● |
| VT | 750 | C / C2 Shadow | 97 - 03 | 1 | ● |
| VT | 750 | C4 Shadow | 04 - | 1 | ● |
| VT | 750 | DC Black Widow | 01 - | 1 | ● |
| VT | 750 | DC7 Shadow spirit | 07 - | 1 | ● |
| DN-01 | 680 | | 08 - | | ● |
| VFR | 750 | F | 88 - 89 | | ● |
| VFR | 750 | F | 90 - 98 | | ● |
| VFR | 950 | F / Carat | 92 - | | ● |

HONDA

| | | | | | |
|-----|------|-------------------------|--|---------|---|
| CBR | 1000 | F | | 89 - 92 | ● |
| VFR | 1000 | | | 89 | ● |
| ST | 1100 | Pan European | | 90 - 02 | ● |
| ST | 1100 | Pan European ABS-TCS | | 92 - 95 | ● |
| GL | 1500 | F6C Custom / C Valkyrie | | 96 - 02 | ● |

SYM

| | | | | | | |
|-----|-----------------|--|--|----|---|---|
| 125 | Cevalo B9A (4T) | | | 10 | 1 | ● |
|-----|-----------------|--|--|----|---|---|

TRIUMPH

| | | | | | |
|-----|--------------------------|--|--|---------|---|
| 900 | Adventurer | | | 96 - | ● |
| 900 | Legend TT | | | 98 - 01 | ● |
| 900 | Thunderbird | | | 95 - 03 | ● |
| 900 | Thunderbird Sport | | | 98 - 04 | ● |
| 900 | Tiger | | | 99 - 00 | ● |
| 955 | Tiger (Up to VIN 198874) | | | 00 - 04 | ● |

VICTORY

| | | | | | |
|---------------|------|---------------------|--|---------|---|
| Kingpin | 1634 | 8-Ball / Low / Tour | | 08 - 10 | ● |
| Vegas | 1634 | Cory Ness Jackpot | | 08 - 10 | ● |
| Vegas | 1634 | / Low | | 08 - 10 | ● |
| Vegas | 1634 | 8-Ball | | 08 - 10 | ● |
| Cross Country | 1731 | | | 10 - | ● |
| Cross Roads | 1731 | | | 10 - | ● |
| Hammer | 1731 | / S | | 08 - 10 | ● |
| Hammer | 1731 | 8-ball | | 10 - | ● |
| Vegas | 1731 | | | 08 - 10 | ● |
| Vegas | 1731 | Jackpot | | 10 - | ● |
| Vision | 1731 | Arien Ness Victory | | 10 - | ● |
| Vision | 1731 | Street / Tour | | 08 - 10 | ● |
| Vision | 1731 | 8-Ball | | 10 - | ● |

YAMAHA

| | | | | | |
|-------|------|----------------------|--|---------|---|
| MT-01 | 1700 | (4 piston caliper) | | 05 - 06 | ● |
| MT-01 | 1700 | (6 piston caliper) | | 07 - 09 | ● |
| MT-01 | 1700 | S (6 piston caliper) | | 09 | ● |

Street Sport Racing Enduro MX Off Road Racing ATV

S4 RX3

X59

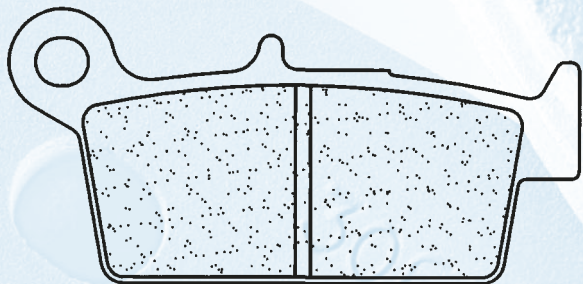

Dim./Size

75 mm
36,1 mm
9,5 mm

2314

| | | | | | |
|-----|-----|-----|--------|------|---|
| AJP | PR5 | 250 | Enduro | 09 - | ● |
|-----|-----|-----|--------|------|---|

| | | | | |
|-----|-----|-------|------|---|
| CPI | 125 | Sahel | 02 - | ● |
|-----|-----|-------|------|---|

FANTIC

| | | | | |
|----|-----|------------------------|------|---|
| MX | 50 | Regolarna Competizione | 08 - | ● |
| MX | 50 | Regolarna Competizione | 08 - | ● |
| MX | 65 | Regolarna Competizione | 08 - | ● |
| MX | 80 | Regolarna Competizione | 08 - | ● |
| MX | 85 | Regolarna Competizione | 08 - | ● |
| MX | 125 | Regolarna Competizione | 08 - | ● |

GAS GAS

| | | | | |
|----|-----|---------|---------|---|
| SM | 125 | | 02 - | ● |
| EC | 125 | | 00 - | ● |
| MC | 125 | | 03 - | ● |
| EC | 200 | Hobby | 07 - | ● |
| EC | 200 | | 00 - | ● |
| SM | 250 | | 02 - | ● |
| EC | 250 | FSE | 02 - | ● |
| EC | 250 | | 00 - | ● |
| MC | 250 | | 00 - | ● |
| EC | 300 | | 00 - | ● |
| SM | 400 | fse | 03 - | ● |
| EC | 400 | fse | 02 - | ● |
| EC | 400 | Pampera | 06 - | ● |
| SM | 450 | fse | 03 - 06 | ● |
| SM | 450 | fsr | 07 - | ● |
| EC | 450 | fse | 03 - | ● |

GAS GAS

| | | | | | |
|----|-----|------------|--|------|---|
| EC | 450 | FSR | | 07 - | ● |
| EC | 500 | fse Enduro | | 06 - | ● |
| EC | 515 | FSR | | 08 - | ● |

HM

| | | | | | |
|-----|-----|---------------|--|---------|---|
| CRE | 125 | X Supermotard | | 02 - 06 | ● |
| CRE | 125 | R Enduro | | 95 - 01 | ● |
| CRE | 125 | F / X | | 09 | ● |
| CRE | 250 | Supermotard | | 02 - 03 | ● |

HONDA

| | | | | | | |
|------|-----|--------------|--|---------|---|---|
| CRM | 50 | | | 88 - 92 | ● | |
| CRM | 50 | | | 93 - 96 | ● | |
| CRM | 75 | R | | 90 - 94 | ● | |
| NS-1 | 75 | | | 92 - | ● | |
| NSR | 80 | R | | 87 - 92 | ● | |
| NSR | 80 | R | | 93 - | ● | |
| CR | 80 | R / RB | | 92 - 02 | ● | |
| CRM | 80 | | | 89 - | ● | |
| CR | 85 | R / R Expert | | 03 - | ● | |
| CR | 125 | RH / RJ / RK | | 87 - 94 | ● | |
| CR | 125 | R | | 95 - 01 | ● | |
| NS | 150 | | | 92 - | 1 | ● |
| SL | 230 | | | 97 - | ● | |
| XLR | 250 | R SPL | | 94 - | ● | |
| CR | 250 | / R | | 87 - 94 | ● | |
| CR | 250 | R | | 95 - 01 | ● | |
| XR | 250 | L | | 91 - 92 | ● | |
| XR | 250 | L | | 93 - 96 | ● | |
| XR | 250 | R | | 90 - 95 | ● | |
| XR | 250 | R | | 96 - 04 | ● | |
| XR | 400 | Supermotard | | 00 - | ● | |
| XR | 400 | R | | 96 - | ● | |
| XR | 440 | R | | 00 - | ● | |
| CR | 500 | R | | 87 - 94 | ● | |
| CR | 500 | R | | 95 - 01 | ● | |
| XR | 600 | R | | 91 - 92 | ● | |
| XR | 600 | R | | 93 - 00 | ● | |
| XR | 650 | L | | 93 - | ● | |
| XR | 650 | R | | 00 - | ● | |

2314 suite

HYOSUNG

| | | | | |
|-----|-----|--|------|---|
| XRX | 400 | | 05 - | ● |
|-----|-----|--|------|---|

KAWASAKI

| | | | | |
|-----|-----|---------|---------|---|
| KX | 125 | | 95 - | ● |
| KLX | 250 | | 98 - 03 | ● |
| KLX | 250 | S | 06 - 07 | ● |
| KLX | 250 | S / SF | 09 - | ● |
| KX | 250 | | 95 - | ● |
| KLX | 250 | | 98 - 07 | ● |
| KLX | 300 | R A2 | 97 - | ● |
| KLX | 400 | R / SR | 03 - | ● |
| KX | 500 | E8 / E9 | 96 - | ● |
| KLX | 650 | R D1 | 96 | ● |

SUZUKI

| | | | | |
|------|-----|-----------------|---------|---|
| DR | 125 | SM | 08 - 10 | ● |
| RM | 125 | T/V/W/X/Y K1-K5 | 96 - 05 | ● |
| RM | 125 | K6 - K9 | 06 - 09 | ● |
| RM | 125 | K10 | 10 - | ● |
| RM | 250 | T/V/W/X/Y K1-K5 | 96 - 05 | ● |
| RM | 250 | K6 - K9 | 06 - 09 | ● |
| RM | 250 | K10 | 10 - | ● |
| DR-Z | 400 | SM | 05 - 09 | ● |
| DR-Z | 400 | E / S | 00 - 08 | ● |

TM

| | | | | |
|-----|-----------|--------------------|---------|---|
| | 80/85 | Minicross / Junior | 96 - 00 | ● |
| | 80/85/100 | Junior Cross | 05 - 07 | ● |
| MX | 85 | JR | 02 - 10 | ● |
| SMR | 125 | (2T) | 05 - 10 | ● |
| MX | 125 | (2T) | 01 - 10 | ● |
| EN | 125 | Enduro (2T) | 01 - 10 | ● |
| EN | 144 | (2T) | 08 - 10 | ● |
| MX | 144 | (2T) | 08 - 10 | ● |
| SME | 250 | (4T) | 04 | ● |
| SM | 250 | | 02 | ● |
| SMM | 250 | F (4T) | 10 | ● |
| SMR | 250 | (2T) | 05 - 08 | ● |
| SMR | 250 | F (4T) | 10 | ● |
| EN | 250 | F Enduro (4T) | 04 - 10 | ● |
| EN | 250 | Enduro (2T) | 01 - 10 | ● |
| EN | 250 | Fi | 10 | ● |
| MX | 250 | (2T) | 01 - 10 | ● |
| MX | 250 | (4T) Cross | 02 - 10 | ● |

TM

| | | | | |
|-----|-----|-------------|---------|---|
| MX | 250 | Fi (4T) | 10 | ● |
| SMR | 300 | (2T) | 05 - 10 | ● |
| EN | 300 | Enduro (2T) | 01 - 10 | ● |
| MX | 300 | (2T) | 01 - 10 | ● |
| SME | 400 | (4T) | 04 | ● |
| SM | 400 | | 02 - 03 | ● |
| MX | 400 | (4T) Cross | 02 - 03 | ● |
| SMR | 450 | FES | 05 - 09 | ● |
| SMR | 450 | F (4T) | 10 | ● |
| SMX | 450 | F | 05 - 10 | ● |
| EN | 450 | F (4T) | 04 - 10 | ● |
| MX | 450 | F (4T) | 04 - 10 | ● |
| SM | 530 | | 02 - 03 | ● |
| SME | 530 | (4T) | 04 | ● |
| SMR | 530 | F | 10 | ● |
| SMR | 530 | F ES | 05 - 09 | ● |
| SMX | 530 | F | 05 - 10 | ● |
| EN | 530 | F (4T) | 04 - 10 | ● |
| | 530 | Cross (4T) | 02 - 03 | ● |
| MX | 530 | F | 05 - 10 | ● |
| SMX | 660 | F | 04 | ● |
| SMX | 660 | F | 05 - 10 | ● |

YAMAHA

| | | | | |
|----|-----|-------------------|---------|---|
| WR | 125 | | 98 - 02 | ● |
| YZ | 125 | K / L / M / N / P | 98 - 02 | ● |
| WR | 250 | ZK/FN/FP | 98 - 02 | ● |
| YZ | 250 | K / L / M (2T) | 98 - 00 | ● |
| YZ | 250 | N / P (2T) | 01 - 02 | ● |
| YZ | 250 | FN / FP (4T) | 01 - 02 | ● |
| WR | 400 | FL / FM / FN (4T) | 99 - 01 | ● |
| YZ | 400 | FL (4T) | 99 | ● |
| WR | 426 | FN / FP (4T) | 00 - 02 | ● |
| YZ | 426 | FM / FN / FP (4T) | 00 - 02 | ● |

| Street | Sport | Racing | Enduro | MX | Off Road Racing | ATV |
|--------|-------|--------|--------|----|-----------------|------|
| S4 | A3+ | RX3 | | | X59 | ATV1 |

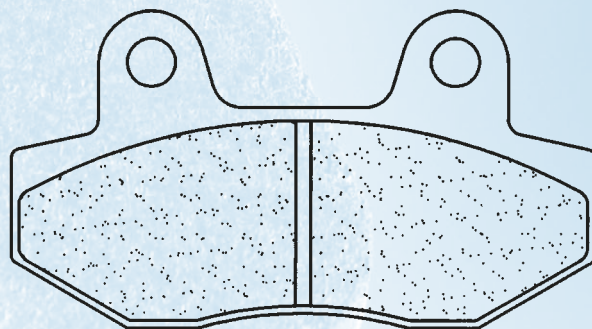
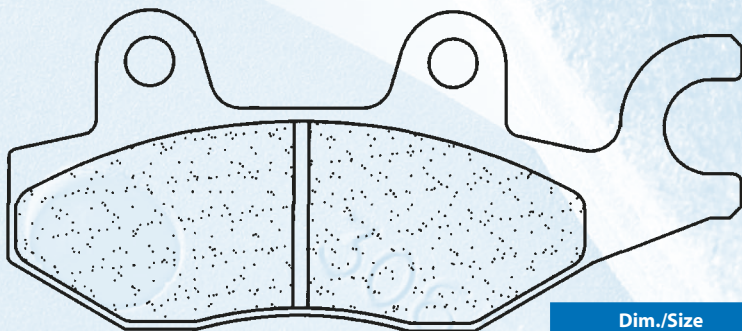

Dim./Size
96,6 mm
42 mm
8 mm

2326

Dim./Size
77 mm
42 mm
8 mm

AEON

| | | | | |
|--|-----|----------|------|---|
| | 125 | Overland | 02 - | ● |
| | 180 | Overland | 02 - | ● |
| | 180 | Roadster | 02 - | ● |

ARCTIC CAT

| | | | | |
|--|----|-----|------|---|
| | 50 | DVX | 06 - | ● |
| | 90 | DVX | 06 - | ● |

CAGIVA

| | | | | | | |
|--|------|-------------|---------|---|---|---|
| | 900 | E.I Canyon | 98 | R | 1 | ● |
| | 500 | Canyon | 99 - | | | ● |
| | 600 | Canyon | 96 | | | ● |
| | 900 | Elefant | 90 - 92 | | | ● |
| | 900 | E.I Canyon | 98 | | | ● |
| | 900 | Gran Canyon | 99 - | | | ● |
| | 1000 | Navigator | 00 - | | | ● |

DAELIM

| | | | | | | |
|--|-----|---------|------|--|--|---|
| | 125 | Roadwin | 04 - | | | ● |
| | 250 | Roadwin | 08 - | | | ● |

HONDA

| | | | | | |
|------|----|---|------|---|---|
| NS-1 | 75 | | 92 - | 1 | ● |
| NSR | 80 | R | 93 - | 1 | ● |

HONDA

| | | | | | |
|-----|-----|----------|------|---|---|
| VT | 125 | Shadow | 99 - | 1 | ● |
| XLV | 125 | Varadero | 01 - | 1 | ● |
| NSR | 150 | | 02 - | 1 | ● |
| CA | 250 | Rebel | 90 - | 1 | ● |
| CBF | 250 | | 04 - | 1 | ● |

JINCHENG

| | | | | | |
|----|-----|-------|------|---|---|
| JC | 125 | 2A/3A | 97 - | 1 | ● |
|----|-----|-------|------|---|---|

KAWASAKI

| | | | | | | |
|-----|-----|-------------------------|---------|---|---|---|
| BN | 125 | Eliminator A3 | 00 - | 1 | ● | |
| | 250 | R Ninja | 08 - | 1 | ● | |
| KLF | 300 | C1-C12 Bayou | 90 - 05 | R | 1 | ● |
| KLF | 400 | B1-B7 Bayou | 93 - 99 | R | 1 | ● |
| KVF | 650 | Brute Force 4X4 i F/G/H | 07 - | R | 1 | ● |
| KRF | 750 | Teryx 4x4 | 08 - | R | 1 | ● |
| KVF | 750 | Brute Force 4X4 i | 04 - | R | 1 | ● |
| KLR | 650 | | 08 - | | | ● |

KREIDLER

| | | | | | |
|--|-----|---------------|------|---|---|
| | 125 | Florett D | 07 - | 1 | ● |
| | 125 | Florett RMC-F | 07 - | 1 | ● |

KYMCO

| | | | | | |
|--|-----|---------|---------|---|---|
| | 125 | Cruiser | 99 - | 1 | ● |
| | 125 | Hipster | 99 - 06 | 1 | ● |

2326 suite

| KYMCO | | | | | | |
|----------|--------------------------|-------|-----|---|--|---|
| 125 | Pulsar | 99-06 | 1 | ● | | |
| 125 | Quannon | 08- | 1 | ● | | ● |
| 125 | Zing | 97-03 | 1 | ● | | |
| 125 | Zing II | 04-09 | 1 | ● | | |
| 150 | Hipster | 99-06 | 1 | ● | | |
| 150 | Zing | 97-09 | 1 | ● | | |
| LONCIN | | | | | | |
| LX | 110 | 02- | 2 | ● | | |
| LX | 125 | 02- | 2 | ● | | |
| MZ / MUZ | | | | | | |
| 125 | RT (All models) | 02-07 | 1 | ● | | ● |
| 125 | SM/SX (All models) | 99-01 | | | | ● |
| 125 | SM/SX (All models) | 02-07 | | | | ● |
| 125 | VRT | | | | | ● |
| 175 | VRT | | | | | ● |
| SUZUKI | | | | | | |
| LT-F | 300 King Quad | 02- | R 1 | ● | | |
| LT-R | 450 Quad Racer | 06- | R 1 | ● | | |
| LT-A | 500 FY1/FK1 Quadmaster | 00- | R 1 | ● | | |
| LT-F | 500 FW/FX/FY2 Quadrunner | 98-02 | R 1 | ● | | |
| DR | 800 SM (SR43A) Big | 91-95 | | | | ● |
| DR | 800 ST Big | 96- | | | | ● |
| SYM | | | | | | |
| XS | 125 K | 07-09 | 1 | ● | | |
| TRIUMPH | | | | | | |
| 750 | Trident | 91-98 | L 1 | ● | | ● |
| 900 | Sprint | 93 | L 1 | ● | | ● |
| 900 | Tiger | 92-98 | L 1 | ● | | ● |
| 900 | Trident | 91-98 | L 1 | ● | | ● |
| 900 | Trophy | 91-95 | L 1 | ● | | ● |
| 1000 | Trophy | 91-95 | L 1 | ● | | ● |
| 1200 | Trophy | 91-95 | L 1 | ● | | ● |
| 750 | Daytona | 91-92 | | | | ● |
| 900 | Bonneville / T100 | 05-08 | | | | ● |

| TRIUMPH | | | | | | |
|---------|-------------------------------|-------|-----|---|--|---|
| 900 | Daytona | 93-96 | | | | ● |
| 900 | Daytona Super III | 94-97 | | | | ● |
| 900 | Speed Triple | 94-96 | | | | ● |
| 900 | Sprint | 94-98 | | | | ● |
| 900 | Sprint Sport Edition | 97-98 | | | | ● |
| 900 | Trophy | 96- | | | | ● |
| 955 | Tiger (From VIN 198875) | 04-06 | | | | ● |
| 1000 | Daytona | 91-95 | | | | ● |
| 1050 | Speed Triple (Brembo Rad.Cal) | 11- | | | | ● |
| 1050 | Tiger | 07- | | | | ● |
| 1200 | Daytona | 93-98 | | | | ● |
| 1200 | Trophy | 96-03 | | | | ● |
| VOXAN | | | | | | |
| 1000 | Scrambler | 06- | | | | ● |
| YAMAHA | | | | | | |
| FZR | 50 | 90-91 | 1 1 | ● | | |
| TZM | 50 R | 94- | 1 1 | ● | | |
| TZR | 50 | 90-92 | 1 1 | ● | | |
| TZR | 50 | 93-02 | 1 1 | ● | | |
| YBR | 250 | 07- | 1 1 | ● | | |
| YZF | 450 S / T / R | 04-05 | R 1 | ● | | |
| YZF | 450 V / W / X | 06-08 | R 1 | ● | | |
| YZF | 450 RY / RZ | 09- | R 1 | ● | | |
| YXR | 450 Rhino | 06- | R 1 | ● | | |
| YXR | 660 Rhino | 04-06 | R 1 | ● | | |
| YFM | 700 R Raptor | 06- | R 1 | ● | | |
| XTZ | 750 Super Ténéré | 89-94 | R 1 | ● | | ● |

| Street | Sport | Racing | Enduro | MX | Off Road Racing | ATV |
|--------|-------|--------|--------|------|-----------------|------|
| S4 | | | | MX10 | X59 | ATV1 |

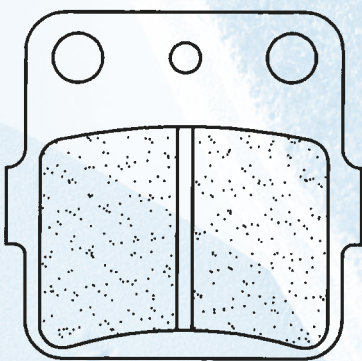

Dim./Size

46,5 mm

45,5 mm

7,5 mm

2328

| ARCTIC CAT | | | | | | |
|------------|-------------------|-------|---|---|--|---|
| 400 | DVX | 04- | 2 | ● | | ● |
| HONDA | | | | | | |
| CR | 80 R | 86-91 | 1 | ● | | |
| CR | 80 R / RB | 92-02 | 1 | ● | | |
| CRM | 80 | 89- | 1 | ● | | |
| CR | 85 R / R Expert | 03- | 1 | ● | | |
| ATC | 200 X | 83-85 | 1 | ● | | ● |
| ATC | 250 R | 82-84 | 1 | ● | | ● |
| TRX | 250 EX Sportrax | 01-08 | 2 | ● | | |
| TRX | 250 X9 | 09- | 2 | ● | | |
| ATC | 250 X | 85 | | | | ● |
| TRX | 300 EX Fourtrax | 93-08 | 2 | ● | | ● |
| TRX | 300 EX Sportrax | 01-08 | 2 | ● | | ● |
| TRX | 300 X9 | 09- | 2 | ● | | ● |
| ATC | 300 X | 86- | | | | ● |
| ATC | 300 X | 85 | | | | ● |
| TRX | 400 EX Fourtrax | 99-08 | 2 | ● | | ● |
| TRX | 400 EX Sportrax | 01-08 | 2 | ● | | ● |
| TRX | 400 X9 | 09- | 2 | ● | | ● |
| TRX | 420 FA / FPA | 09- | 2 | ● | | ● |
| TRX | 420 FPE / FPM 4x4 | 09- | 2 | ● | | ● |
| TRX | 450 EX Sportrax | 01- | 2 | ● | | ● |
| HYOSUNG | | | | | | |
| TE | 450 Rapier | 06- | | | | ● |
| KAWASAKI | | | | | | |
| KX | 80 L / N / R-R6 | 88-96 | | | | ● |
| KX | 80 | 97-00 | | | | ● |
| KX | 85 | 01- | | | | ● |

| KAWASAKI | | | | | | |
|----------|----------------------------|-------|---|---|--|---|
| KX | 100 | 88-92 | | | | ● |
| KX | 100 B5 / B6 | 95-96 | | | | ● |
| KX | 100 B7 | 97- | | | | ● |
| KSF | 250 A1-A17 Mojave | 87- | | | | ● |
| KXF | 250 A1 / A2 Tecate | 87-88 | | | | ● |
| KXT | 250 B2 Tecate Trike | 85- | | | | ● |
| KEF | 300 A1-A6 Lakota | 95- | | | | ● |
| KFX | 400 | 02- | | | | ● |
| KFX | 450 | 07- | L | | | ● |
| MONTESA | | | | | | |
| 80 | Junior | 96- | | | | ● |
| SUZUKI | | | | | | |
| RM | 100 | 03 | | | | ● |
| RM | 125 J | 88 | | | | ● |
| LT | 230 EH/EJ/EK/EL/EM/EN/EP | 86-93 | | | | ● |
| LT | 230 SF / SG / SH / SJ | 85-88 | | | | ● |
| RM | 250 H / J | 87-88 | | | | ● |
| LT | 250 RF / RG / RH | 85-87 | | | | ● |
| LT | 250 RJ/RK/RL/RM/RN | 88-94 | | | | ● |
| LT | 250 SK / SL | 89-90 | | | | ● |
| LT-Z | 400 Quad Sport | 03-10 | | | | ● |
| LT-R | 450 Quad Racer | 06- | L | | | ● |
| RM | 500 H | 87- | | | | ● |
| LT | 500 RH / RJ / RK / RL | 87-90 | | | | ● |
| DR-Z | 800 Paris Dakar | 88-90 | | | | ● |
| YAMAHA | | | | | | |
| YZ | 80 E / F / G / H1 / J1 | 93-01 | | | | ● |
| YZ | 85 All models | 02-10 | | | | ● |
| YZ | 125 V / W | 89 | | | | ● |
| YFS | 200 R Blaster | 03-06 | | | | ● |
| YZ | 250 W / WRW (2T) | 89 | | | | ● |
| YFM | 250 R Raptor | 08- | L | | | ● |
| YFM | 300 Warrior | 89 | | | | ● |
| YFM | 350 R Raptor | 04-09 | 2 | ● | | ● |
| YFM | 350 Wolverine 4x2 | 95-05 | | | | ● |
| YFM | 350 Warrior XT/XU | 87-88 | | | | ● |
| YFM | 350 Warrior XW/XA-M | 89- | | | | ● |
| YFM | 350 XA - M Warrior | 92-04 | | | | ● |
| YFZ | 350 Banshee (A-M) | 87-89 | | | | ● |
| YFZ | 350 Banshee (T-W) | 90-09 | | | | ● |
| YZ | 360 | 89 | | | | ● |
| YFM | 400 FWP Big Bear 4x4 | 02 | 2 | ● | | ● |
| YFZ | 450 S / T / R | 04-05 | L | | | ● |
| YFM | 600 Grizzly FWAK-FWAN | 98-01 | 2 | ● | | ● |
| YFM | 600 Grizzly Hunting HM/HMC | 00- | 2 | ● | | ● |

Street Sport Racing Enduro MX Off Road Racing ATV

XBK5 C59

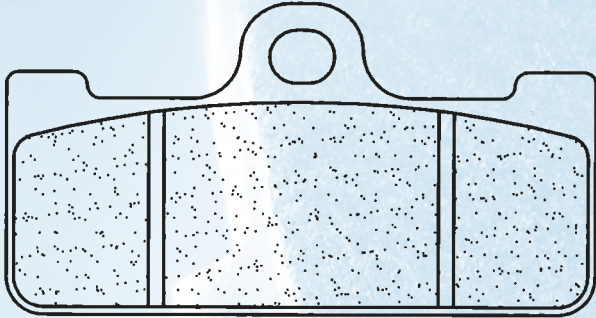

Dim./Size
77,7 mm
41 mm
8,5 mm

2329

| | | | | | |
|----------------|-----|-------------------------------------|------|---|---|
| APRILIA | | | | | |
| SXV | 450 | Van den Bosh Rep. | 08 - | 1 | ● |
| SXV | 550 | Van den Bosh Rep. | 08 - | 1 | ● |
| BREMBO | | | | | |
| | | P32x36 Monobloc Caliper - Racing | | 1 | ● |
| | | P4 Radial 2 Pieces Caliper - Racing | | 1 | ● |
| | | P4 Radial Monobloc Caliper - Racing | | 1 | ● |

Street Sport Racing Enduro MX Off Road Racing ATV

S4 A3+ RX3

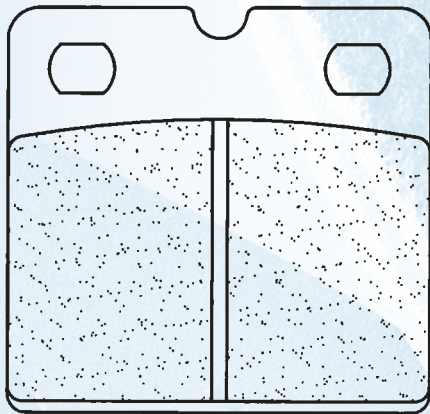

Dim./Size
55,7 mm
54 mm
8,9 mm

2332

| | | | | | |
|------------|------|------------|---------|---|---|
| BMW | | | | | |
| K | 1100 | All models | 92 - | | ● |
| K | 1100 | LT / LTS | 92 - | | ● |
| K | 1100 | RS / RT | 93 - | | ● |
| K | 1100 | RS ABS | 93 - | | ● |
| R | 1100 | RS | 93 | | ● |
| R | 1100 | RS ABS | 93 - | | ● |
| K | 1200 | GT ABS | 02 - 04 | | ● |
| K | 1200 | RS | 99 - 01 | | ● |
| CZ | | | | | |
| CZ | 180 | | 93 - | 1 | ● |

| | | | | | |
|----------------|------|--------------|------------|---|---|
| APRILIA | | | | | |
| AF 1 | 250 | Replica | 90 - | | ● |
| BENELLI | | | | | |
| | 350 | 4T Turismo | | | ● |
| | 354 | | 78 - 82 | | ● |
| | 500 | 4T | - 76 | | ● |
| | 750 | Sei | 75 - | 2 | ● |
| | 900 | Sei | 84 - | 2 | ● |
| BIMOTA | | | | | |
| | | All models | 82 - 88 | 2 | ● |
| BMW | | | | | |
| R65 | 650 | | 86 - | 1 | ● |
| R65 | 650 | GS | 87 - 92 | 1 | ● |
| R65 | 650 | LS | 82 - | 2 | ● |
| R65/1 | 650 | | 86 - | | ● |
| K75 | 750 | C | 85 - 08/89 | 2 | ● |
| K75 | 750 | S | 85 - 08/88 | 2 | ● |
| K75 | 750 | | 09/88 - | | ● |
| K75 | 750 | RT (ABS) | 91 - | | ● |
| K75 | 750 | S | 09/88 - | | ● |
| R80 | 800 | GS | 81 - 84 | 1 | ● |
| R80 | 800 | RT | 83 | 2 | ● |
| K1 | 1000 | | 89 - 93 | | ● |
| K100 | 1000 | LT / RS / RT | 83 - 08/88 | 2 | ● |
| K100 | 1000 | GS | 87 - 93 | | ● |
| K100 | 1000 | LT | 92 - | | ● |
| K100 | 1000 | LT / RS | 09/88 - 90 | | ● |
| K100 | 1000 | LT ABS | 89 | | ● |
| R100 | 1000 | RS (4V) | 90 - 92 | | ● |
| R100 | 1000 | RT | 91 - | | ● |

| | | | | | |
|-----------------|------|---------------------------|---------|---|---|
| DUCATI | | | | | |
| | 250 | Desmo | - 77 | 1 | ● |
| | 350 | Desmo | - 77 | 1 | ● |
| | 500 | Pantah | 85 - | 2 | ● |
| | 500 | Sport | 77 - | 2 | ● |
| | 600 | Pantah TL / SL | 81 | 2 | ● |
| | 650 | Pantah | 84 - | 2 | ● |
| | 750 | F1 | 86 - | 2 | ● |
| | 750 | GT | 74 - 76 | 2 | ● |
| | 750 | Paso | 87 | 2 | ● |
| | 750 | Sport | 90 | 2 | ● |
| | 750 | Supersport | 74 - 90 | 2 | ● |
| | 750 | Supersport | 91 - 94 | | ● |
| | 851 | Strada | 91 - | | ● |
| | 880 | GT | 75 - 76 | 1 | ● |
| | 888 | Roche Replica | 91 - | | ● |
| | 900 | GTS | 77 - | 1 | ● |
| | 900 | Mike Hailwood Replica | 85 - | 2 | ● |
| | 900 | S2 Desmo | 85 - | 2 | ● |
| | 900 | Sport | 77 - | 2 | ● |
| | 900 | Supersport | 78 - 89 | 2 | ● |
| | 900 | Supersport | 90 - 94 | | ● |
| | 1000 | / 6 Mike Hailwood Replica | 85 - | 2 | ● |
| | 1000 | Mille Replica | 84 - | 2 | ● |
| | 1000 | S2 Desmo | 85 - | 2 | ● |
| HERCULES | | | | | |
| | | Silver Star Classic | 93 - | 1 | ● |
| | 50 | Ultra | 79 - 83 | 1 | ● |

Street Sport Racing Enduro MX Off Road Racing ATV

S4 A3+ RX3

| Model | Year | Category | Enduro | MX | Off Road Racing | ATV |
|-------------------|-----------|-----------------------|---------|----|-----------------|-----|
| HOREX | | | | | | |
| 80 | Rebell T | | 86 - | 2 | ● | ● |
| 80 | Sport L | | 86 - | 2 | ● | ● |
| 125 | Imperator | | 96 - | 1 | ● | ● |
| 125 | Regent | | 96 - | 1 | ● | ● |
| 560 | E | | 86 - | 2 | ● | ● |
| 600 | Columbus | | 87 - | 2 | ● | ● |
| LAVERDA | | | | | | |
| SFC | 500 | | | 2 | ● | ● |
| SFC | 600 | | 86 - | 2 | ● | ● |
| | 650 | V Six | 93 - | 2 | ● | ● |
| SF2 | 750 | | 74 - 78 | 2 | ● | ● |
| SF3 | 750 | | 74 - 78 | 2 | ● | ● |
| SF3 | 750 | RGS Corsa / Executive | 77 - | 2 | ● | ● |
| 3C | 1000 | 3CE / 3CL | 74 - | 2 | ● | ● |
| RGS | 1000 | Jota | 86 - | 2 | ● | ● |
| RGS | 1000 | | 83 - | 2 | ● | ● |
| SFC | 1000 | | 85 - 86 | 2 | ● | ● |
| TGA | 1000 | Executive | 84 - | 2 | ● | ● |
| | 1000 | Jota | 76 - | 2 | ● | ● |
| | 1200 | Mirage | 78 - | 2 | ● | ● |
| MOTO GUZZI | | | | | | |
| NTX | 350 | | 90 - | | ● | ● |
| V35 | 350 | C | | 2 | ● | ● |
| V35 | 350 | III | 87 - | 2 | ● | ● |
| V35 | 350 | Florida | | 2 | ● | ● |
| V35 | 350 | GT | 90 - | 1 | ● | ● |
| V35 | 350 | TT | 86 - | 2 | ● | ● |
| NTX | 650 | | 90 - | | ● | ● |
| V65 | 650 | Florida | 86 - | 2 | ● | ● |
| V65 | 650 | GT | 90 - | 1 | ● | ● |
| NTX | 750 | | 90 - | | ● | ● |
| S3 | 750 | | 75 - 76 | 2 | ● | ● |
| SP | 750 | | 91 - | 1 | ● | ● |
| V75 | 750 | | 86 - | 2 | ● | ● |
| V75 | 750 | Duna | 86 - | 1 | ● | ● |
| V75 | 750 | Paris Dakar TT | 86 - | 1 | ● | ● |
| T | 850 | | 74 - 76 | 1 | ● | ● |
| T3 | 850 | | 75 - | 2 | ● | ● |
| T4 | 850 | | 75 - | 2 | ● | ● |
| T5 | 850 | | 75 - | 2 | ● | ● |
| T5 | 850 | N.T. | 86 - | 1 | ● | ● |

2332 suite

| Model | Year | Category | Enduro | MX | Off Road Racing | ATV |
|-------------------|--------------------------|------------------|---------|----|-----------------|-----|
| MOTO GUZZI | | | | | | |
| 850 | Le Mans | | 76 - | 2 | ● | ● |
| 1000 | California II | | 85 - 88 | 2 | ● | ● |
| 1000 | California III Fuel Inj. | | 89 - | 2 | ● | ● |
| GT | 1000 | V | 91 - | 2 | ● | ● |
| S | 1000 | | 90 - | 2 | ● | ● |
| SP | 1000 | III | 91 - | 2 | ● | ● |
| SP | 1000 | Le Mans | 79 - | 1 | ● | ● |
| V | 1000 | Strada | 93 - 94 | 2 | ● | ● |
| | 1000 | California III C | 91 - 95 | 2 | ● | ● |
| | 1000 | Le Mans IV | 85 - | 2 | ● | ● |
| | 1000 | Le Mans V | 90 - 95 | 2 | ● | ● |
| | 1000 | Daytona | 91 - | | ● | ● |
| | 1100 | California | 94 - 97 | 2 | ● | ● |
| MZ / MUZ | | | | | | |
| 125 | ETZ | | 82 - 92 | 1 | ● | ● |
| 125 | Roadstar | | | 1 | ● | ● |
| 125 | Saxon | | 93 - 97 | 1 | ● | ● |
| 125 | Sportstar | | 93 - | 1 | ● | ● |
| 150 | ETZ | | 82 - 92 | 1 | ● | ● |
| 150 | Saxon | | 95 - | 1 | ● | ● |
| 250 | ETZ | | 82 - 92 | 1 | ● | ● |
| 251 | ETZ | | 89 - | 1 | ● | ● |
| 251 | Fun | | 95 - 96 | 1 | ● | ● |
| 251 | Saxon Tour | | | 1 | ● | ● |
| 300 | ETZ | | 82 - 92 | 1 | ● | ● |
| 301 | ETZ | | 90 - | 1 | ● | ● |
| 301 | Saxon Tour | | | 1 | ● | ● |
| 301 | Sportstar | | 96 - | 1 | ● | ● |
| 500 | Saxon (All Models) | | 93 - 98 | 1 | ● | ● |
| 500 | Silver Star Classic | | 93 - | 1 | ● | ● |
| 500 | Silverstar Voyager | | 96 - | 1 | ● | ● |
| 500 | Tour | | 96 - | 1 | ● | ● |
| NORTON | | | | | | |
| 588 | Classic | | 89 - | 2 | ● | ● |
| 588 | Interpol 2 (Rotary) | | 89 - | 2 | ● | ● |
| TRIUMPH | | | | | | |
| 750 | Bonneville T140 | | 85 - 88 | 2 | ● | ● |

Street Sport Racing Enduro MX Off Road Racing ATV

RX3

| Model | Year | Category | Enduro | MX | Off Road Racing | ATV |
|------------------------|------|-----------------------|--------|----|-----------------|-----|
| HARLEY DAVIDSON | | | | | | |
| FLHS | 1340 | Electra Glide Sport | | | | ● |
| FLHTC | 1340 | Electra Glide Classic | | | | ● |
| FLHTC | 1340 | Ultra Classic | | | | ● |
| FLST | 1340 | Heritage Softail | | | | ● |
| FLST | 1340 | Heritage Softail | | | | ● |
| FLT | 1340 | Series | | | | ● |
| FLT/H | 1340 | Series | | | | ● |
| FLTC | 1340 | Tour Glide Classic | | | | ● |
| FXDL | 1340 | Dyna Low Rider | | | | ● |
| FXDWG | 1340 | Dyna Wide Glide | | | | ● |

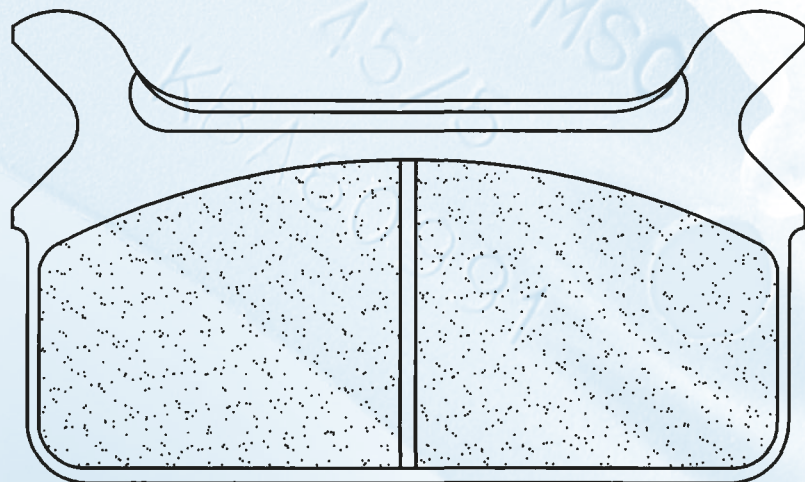

2342

| Dim./Size | Value |
|-----------|---------|
| → | 104 mm |
| ↑ | 62 mm |
| H | 11,5 mm |

| Street | Sport | Racing | Enduro | MX | Off Road Racing | ATV |
|--------------|-------|--------|--------|------|-----------------|------|
| A3+ RX3 XBK5 | | | EN10 | MX10 | X59 | ATV1 |

| Dim./Size |
|-----------|
| 94 mm |
| 36 mm |
| 7,6 mm |

2352

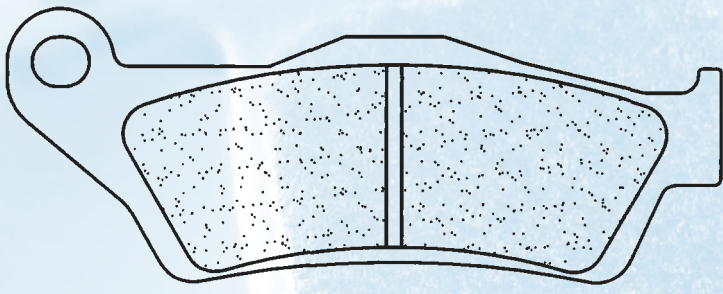

| | | | | | | |
|-----------------|------|---------------------|---------|---|---|---|
| ALFER | | | | | | |
| VRE | 125 | | 00 - | 1 | ● | |
| VR | 250 | All Models | 99 - | 1 | ● | |
| VR | 250 | Supermotard | 99 - | 1 | ● | |
| APRILIA | | | | | | |
| MX | 125 | | 04 - | 1 | ● | |
| MX | 125 | SM | 07 - | 1 | ● | |
| RX | 125 | | 97 - | 1 | ● | |
| RX | 125 | Enduro | 08 - | 1 | ● | |
| RX | 125 | Supermotard | 08 - | 1 | ● | |
| SX | 125 | | 08 - | 1 | ● | |
| RST | 1000 | Futura | 01 - | | | ● |
| BENELLI | | | | | | |
| BX | 449 | Cross | 07 - | 1 | ● | |
| | 505 | Enduro | 08 - | 1 | ● | |
| BMW | | | | | | |
| G | 450 | Enduro | 08 - | 1 | ● | |
| HP2 | 1200 | Sport | 08 - | | | ● |
| CAGIVA | | | | | | |
| E | 750 | | 96 - | 2 | ● | ● |
| | 750 | Elefant | 94 - 95 | | | ● |
| | 900 | Elefant | 93 - 95 | 1 | ● | ● |
| E | 900 | | 96 - | 2 | ● | ● |
| CCM | | | | | | |
| MX | 450 | | 08 - | 1 | ● | |
| | 604 | DS Supermoto | 99 - 01 | 1 | ● | |
| | 604 | RS Roadster | 01 | 1 | ● | |
| | 644 | DS Supermoto | 02 - | 1 | ● | |
| | 644 | RC 30 | 02 - | 1 | ● | |
| DUCATI | | | | | | |
| | 620 | Monster | 05 - 06 | 2 | ● | |
| | 620 | Monster Dark | 06 - | 2 | ● | |
| | 620 | Multistrada | 05 - | 2 | ● | |
| | 695 | Monster | 06 - | 2 | ● | |
| | 800 | Monster S2R | 05 - 07 | 2 | ● | |
| | 800 | Monster S2R Dark | 05 - 06 | 2 | ● | |
| FACTORY | | | | | | |
| YR | 250 | | 99 - | 1 | ● | |
| GAS GAS | | | | | | |
| | 50 | Wild HP | 04 - | 2 | ● | ● |
| | 125 | Enducross | 93 - 96 | 1 | ● | |
| EC | 125 | | 97 - 99 | 1 | ● | |
| EC | 200 | | 99 | 1 | ● | |
| | 200 | Wild HP | 08 - | 2 | ● | ● |
| | 240 | Wild HP | 04 - | 2 | ● | ● |
| EC | 250 | | 97 - 99 | 1 | ● | |
| MC | 250 | | 97 - 99 | 1 | ● | |
| | 250 | Wild HP | 08 - | 2 | ● | ● |
| EC | 300 | | 99 | 1 | ● | |
| | 300 | Wild HP | 03 - | 2 | ● | ● |
| | 450 | Wild HP | 03 - | 2 | ● | ● |
| | 515 | Wild HP | 09 - | 2 | ● | ● |
| HIGHLAND | | | | | | |
| | 450 | MX | 06 - | 1 | ● | |
| | 950 | Outback V2 | 99 - | 1 | ● | |
| | 950 | V2 Motard | 00 - | 1 | ● | |
| HONDA | | | | | | |
| NX | 500 | Dominator (Austria) | 97 - | 1 | ● | |
| HUSABERG | | | | | | |
| | | All models | 93 - | 1 | ● | |
| CR | 125 | | 05 - | 1 | ● | |
| CR | 125 | | 96 - 04 | 1 | ● | |
| SM | 125 | S | 00 - 05 | 1 | ● | |
| SM | 125 | S | 06 | 1 | ● | |
| SM | 125 | | 98 - 99 | 1 | ● | |
| WR | 125 | | 97 - | 1 | ● | |
| WRE | 125 | SM | 99 - | 1 | ● | |
| WRE | 125 | | 96 - | 1 | ● | |
| CR | 250 | | 97 - 04 | 1 | ● | |
| CR | 250 | | 05 - | 1 | ● | |

HUSABERG

| | | | | | | |
|----------------------------|-----|--------------------|---------|---|---|--|
| TC | 250 | | 04 - | 1 | ● | |
| TC | 250 | | 02 - 03 | 1 | ● | |
| TE | 250 | | 02 - | 1 | ● | |
| WR | 250 | | 97 - | 1 | ● | |
| TE | 350 | | 96 - | 1 | ● | |
| WR | 360 | | 97 - | 1 | ● | |
| FC | 400 | | 99 - 02 | 1 | ● | |
| FE | 400 | E | 99 - 03 | 1 | ● | |
| TE | 400 | | 01 - | 1 | ● | |
| TE | 410 | | 97 - | 1 | ● | |
| FC | 450 | | 03 - | 1 | ● | |
| FE | 450 | / E | 04 - 08 | 1 | ● | |
| FE | 450 | | 09 - | 1 | ● | |
| FX | 450 | E | 03 - | 1 | ● | |
| TC | 450 | | 04 - | 1 | ● | |
| TC | 450 | | 02 - 03 | 1 | ● | |
| TE | 450 | | 02 - | 1 | ● | |
| FC | 470 | / E | 01 - 02 | 1 | ● | |
| FX | 470 | / E | 01 - 02 | 1 | ● | |
| FE | 501 | e SM | 00 | 1 | ● | |
| FE | 501 | E | 99 - 04 | 1 | ● | |
| FC | 501 | | 99 - 01 | 1 | ● | |
| TC | 510 | | 02 - 03 | 1 | ● | |
| TC | 510 | | 04 - | 1 | ● | |
| TE | 510 | | 02 - 03 | 1 | ● | |
| TE | 510 | | 04 - 05 | 1 | ● | |
| TE | 510 | | 06 - | 1 | ● | |
| FC | 550 | | 01 - | 1 | ● | |
| FE | 550 | E | 04 - | 1 | ● | |
| FE | 570 | | 09 - | 1 | ● | |
| TC | 570 | | 01 - | 1 | ● | |
| TE | 570 | | 01 - | 1 | ● | |
| FC | 600 | | 94 - | 1 | ● | |
| FC | 600 | | 99 - 01 | 1 | ● | |
| FE | 600 | e SM | 00 | 1 | ● | |
| FE | 600 | E | 99 - 02 | 1 | ● | |
| TC | 610 | Cross | 97 - | 1 | ● | |
| TE | 610 | | 97 - | 1 | ● | |
| TE | 610 | E | 06 | 1 | ● | |
| TE | 630 | | 10 - | 1 | ● | |
| FE | 650 | E | 01 - | 1 | ● | |
| FX | 650 | E | 01 - | 1 | ● | |
| KRAM IT | | | | | | |
| GS | 250 | | 97 - | 1 | ● | |
| MX | 250 | | 97 - | 1 | ● | |
| SM | 250 | | 00 - | 1 | ● | |
| KTM | | | | | | |
| | 125 | Euro Trail | 96 - | 1 | ● | |
| EXC | 125 | Enduro | 99 - 03 | 1 | ● | |
| EXC | 125 | Enduro | 04 - | 1 | ● | |
| GS | 125 | | 92 - | 1 | ● | |
| LC2 | 125 | | 99 - | 1 | ● | |
| MX | 125 | | 92 - 93 | 1 | ● | |
| MXC125/ 250/ 300/ 500/ 550 | | | 92 - 93 | 1 | ● | |
| SX | 125 | SM | 00 - | 1 | ● | |
| SX | 125 | | 04 - | 1 | ● | |
| SX | 125 | | 96 - 03 | 1 | ● | |
| SX | 144 | | 07 - 08 | 1 | ● | |
| SX | 150 | | 09 - | 1 | ● | |
| EXC | 200 | Enduro | 99 - 03 | 1 | ● | |
| EXC | 200 | Enduro | 04 - | 1 | ● | |
| SX | 200 | | 02 | 1 | ● | |
| SX | 200 | | 03 - 04 | 1 | ● | |
| EXC | 250 | Enduro / Enduro 4T | 99 - 03 | 1 | ● | |
| EXC | 250 | Enduro / Enduro 4T | 04 - | 1 | ● | |
| EXC-F | 250 | Enduro 4T | 06 - 10 | 1 | ● | |
| MX | 250 | | 92 - 93 | 1 | ● | |
| SX | 250 | | 03 - | 1 | ● | |
| SX | 250 | | 96 - 02 | 1 | ● | |
| SX-F | 250 | | 06 - | 1 | ● | |
| EXC | 300 | | 93 - 96 | 1 | ● | |
| EXC | 300 | Enduro | 99 - 03 | 1 | ● | |
| EXC | 300 | Enduro | 04 - | 1 | ● | |
| MX | 300 | | 92 - | 1 | ● | |
| MX | 360 | | 96 - 97 | 1 | ● | |
| SX | 360 | | 96 - 97 | 1 | ● | |
| XC | 360 | | 96 - 97 | 1 | ● | |
| EXC | 380 | Enduro | 98 - | 1 | ● | |
| MX | 380 | | 98 - | 1 | ● | |
| SX | 380 | | 98 - 02 | 1 | ● | |
| XC | 380 | | 98 - | 1 | ● | |
| EXC | 400 | Racing | 00 - 03 | 1 | ● | |
| EXC | 400 | Racing | 04 - | 1 | ● | |
| LC4 | 400 | | 93 - 98 | 1 | ● | |

1 - 2 = Nombre de jeux / Number of sets
L = Gauche / Left - R = Droite / Right

| Street | Sport | Racing | Enduro | MX | Off Road Racing | ATV |
|--------|-------|--------|--------|------|-----------------|------|
| A3+ | RX3 | XBK5 | EN10 | MX10 | X59 | ATV1 |

2352 suite

| KTM | | | | | | |
|-------------|-------------------|----------------------------|---------|---|---|---|
| LC4-E | 400 | Enduro | 99 - | 1 | ● | |
| SC | 400 | Supercompetition | 96 - 99 | 1 | ● | |
| SX | 400 | Racing | 00 - 02 | 1 | ● | |
| SXC | 400 | Tiainen Replica | 97 - | 1 | ● | |
| EXC | 450 | | 03 | 1 | ● | |
| EXC | 450 | Racing | 04 - | 1 | ● | |
| SX | 450 | | 03 - | 1 | ● | |
| XC-F | 450 | | 08 - | 1 | ● | |
| MX | 500 | | 92 - 93 | 1 | ● | |
| SX-F | 505 | | 07 - 08 | 1 | ● | |
| XC-F | 505 | | 09 - | 1 | ● | |
| EXC | 520 | Racing | 00 - 02 | 1 | ● | |
| SX | 520 | Racing | 00 - 02 | 1 | ● | |
| EXC | 525 | Racing | 03 | 1 | ● | |
| EXC | 525 | Racing | 04 - | 1 | ● | |
| MXC | 525 | Desert | 03 - 04 | 1 | ● | |
| SX | 525 | Racing | 03 | 1 | ● | |
| SX | 525 | Racing | 04 - 06 | 1 | ● | |
| EXC | 530 | Racing | 08 | 1 | ● | |
| SXC | 540 | Tiainen Replica | 99 - 00 | 1 | ● | |
| LC4 | 600 | Six Days | 92 - | 1 | ● | |
| EGS | 620 | Enduro / EGS-E | 96 - 99 | 1 | ● | |
| EGS | 620 | Adventure / Rallye / EGS-E | 99 | 1 | ● | |
| LC4 | 620 | SC Supermoto | 00 | 1 | ● | |
| LC4 | 620 | Supercompetition | 96 - 00 | 1 | ● | |
| LC4 | 620 | SX | 95 - 99 | 1 | ● | |
| LC4 | 625 | SC Supermoto | 02 - 04 | 1 | ● | |
| SXC | 625 | | 03 - 04 | 1 | ● | |
| LC4 | 640 | Adventure R | 00 | 1 | ● | |
| LC4 | 640 | Adventure | 01 - 02 | 1 | ● | |
| LC4 | 640 | Adventure (2 sets) | 03 - 07 | 2 | ● | |
| LC4 | 640 | Adventure R | 00 | 1 | ● | |
| LC4 | 640 | Adventure | 01 - 02 | 1 | ● | |
| LC4 | 640 | Adventure (2 sets) | 03 - 07 | 1 | ● | |
| LC4 | 640 | E Enduro | 99 - | 1 | ● | |
| LC4-E | 640 | Supermoto | 99 - 06 | 1 | ● | |
| LC4 | 660 | Rally | 01 - | 1 | ● | |
| | 950 | SM | 05 - | | | ● |
| | 950 | SMR | 07 | | | ● |
| | 950 | Superenduro | 06 - | | | ● |
| | 990 | Adventure / S | 06 - 08 | | | ● |
| | 990 | Supermoto / R | 07 - | | | ● |
| | 990 | Super moto T | 09 - | | | ● |
| MAICO | | | | | | |
| 250 | Motocross | | 99 - | 1 | ● | |
| 250 | Enduro | | 99 - | 1 | ● | |
| 500 | Supermotard | | 99 - | 1 | ● | |
| 500 | Motocross | | 99 - | 1 | ● | |
| 500 | Enduro | | 99 - | 1 | ● | |
| MONTESA | | | | | | |
| 80 | Cross | | 96 - | 1 | ● | |
| 125 | | | 96 - | 1 | ● | |
| 250 | E | | 95 - | 1 | ● | |
| 320 | Cota | | 96 - | 1 | ● | |
| MOTO GUZZI | | | | | | |
| 850 | Breva | | 07 - | | | ● |
| 850 | Griso | | 07 - | | | ● |
| 850 | Norge | | 07 - | | | ● |
| 1100 | Breva V1100 | | 05 | | | ● |
| 1100 | Breva | | 05 - 06 | | | ● |
| 1100 | Breva (ABS) | | 07 | | | ● |
| 1100 | Griso | | 05 - | | | ● |
| 1100 | Griso 8v | | 07 - 08 | | | ● |
| ES | 1100 | Quota | 99 - 01 | | | ● |
| 1200 | Breva | | 08 - | | | ● |
| 1200 | Griso 8V | | 07 - | | | ● |
| 1200 | Norge | | 06 - | | | ● |
| 1200 | Norge GT 8V | | 10 - | | | ● |
| 1200 | Sport ABS | | 06 - 07 | | | ● |
| 1200 | Sport 2V | | 06 - 09 | | | ● |
| 1200 | Sport 4V | | 08 - 09 | | | ● |
| 1200 | Stelvio (ABS) | | 08 - | | | ● |
| 1200 | Stelvio NTX (ABS) | | 09 - | | | ● |
| MOTO MORINI | | | | | | |
| 1200 | Granferro | | 10 | | | ● |
| 1200 | Granpasso | | 08 - 10 | | | ● |
| 1200 | GT | | 10 | | | ● |
| PRAGA | | | | | | |
| ED | 250 | | 99 - | 1 | ● | |
| CD | 610 | | 99 - | 1 | ● | |
| RIEJU | | | | | | |
| 250 | Marathon | | 09 - 10 | 1 | ● | |
| 450 | Marathon | | 09 - 10 | 1 | ● | |

SHERCO

| | | | | |
|-----|---------------------------------|---------|---|---|
| 250 | SM 2.5i Supermotard (4T) | 08 - | 1 | ● |
| 250 | Enduro 2.5i (4T) Inc. SE Models | 08 - 10 | 1 | ● |
| 250 | SX 2.5i F Moto Cross | 10 - | 1 | ● |
| 300 | Enduro SE 3.0i (4T) | 10 - | 1 | ● |
| 450 | SM 4.5i F (Supermotard) | 04 - 10 | 1 | ● |
| 450 | Enduro 4.5i (4T) | 04 - 10 | 1 | ● |
| 510 | SM 5.1i F Supermotard | 07 | 1 | ● |
| 510 | Enduro 5.1i F | 07 - 10 | 1 | ● |

TM

| | | | | |
|-----------|----------------------------|---------|---|---|
| 80/85/100 | Junior Cross (Small Wheel) | 02 - 04 | 1 | ● |
| 80/85/100 | Junior Cross | 05 - 07 | 1 | ● |
| 80/85/100 | (Big Wheel) | 02 - 04 | 1 | ● |
| 80 | Enduro | 96 - 00 | 1 | ● |
| 80/85 | Minicross / Junior | 96 - 00 | 1 | ● |
| 80/85 | Cross | 96 - 01 | 1 | ● |
| MX | 85 JR | 02 - 10 | 1 | ● |
| | 125 Cross | 95 - 00 | 1 | ● |
| MX | 125 (2T) | 01 - 10 | 1 | ● |
| | 125 Enduro | 95 - 00 | 1 | ● |
| EN | 125 Enduro (2T) | 01 - 10 | 1 | ● |
| EN | 144 (2T) | 08 - 10 | 1 | ● |
| MX | 144 (2T) | 08 - 10 | 1 | ● |
| | 250 Enduro | 95 - 00 | 1 | ● |
| EN | 250 F Enduro (4T) | 04 - 10 | 1 | ● |
| EN | 250 Enduro (2T) | 01 - 10 | 1 | ● |
| EN | 250 Fi | 10 | 1 | ● |
| | 250 Cross | 95 - 00 | 1 | ● |
| MX | 250 (2T) | 01 - 10 | 1 | ● |
| MX | 250 (4T) Cross | 02 - 10 | 1 | ● |
| MX | 250 Fi (4T) | 10 | 1 | ● |
| | 300 Enduro (2T) | 95 - 00 | 1 | ● |
| EN | 300 Enduro (2T) | 01 - 10 | 1 | ● |
| | 300 Cross | 95 - 00 | 1 | ● |
| MX | 300 (2T) | 01 - 10 | 1 | ● |
| MX | 400 (4T) Cross | 02 - 03 | 1 | ● |
| | 400 Cross (4T) | 95 - 00 | 1 | ● |
| EN | 450 F (4T) | 04 - 10 | 1 | ● |
| MX | 450 F (4T) | 04 - 10 | 1 | ● |
| | 530 Cross (4T) | 98 - 00 | 1 | ● |
| EN | 530 F (4T) | 04 - 10 | 1 | ● |
| MX | 530 F | 05 - 10 | 1 | ● |

VERTEMATI

| | | | | | |
|----|-----|---------------|------|---|---|
| SR | 450 | Motard Racing | 04 - | 1 | ● |
| S | 501 | E Motard | 04 - | 1 | ● |
| S | 501 | Supermoto | 01 - | 1 | ● |
| S | 570 | E Motard | 03 - | 1 | ● |
| SR | 600 | Motard Racing | 04 - | 1 | ● |
| C | 500 | Cross | 02 - | 1 | ● |
| E | 500 | Enduro | 02 - | 1 | ● |

VOR

| | | | | | |
|----|-----|--|------|---|---|
| EN | 400 | | 00 - | 1 | ● |
| MX | 400 | | 00 - | 1 | ● |
| EN | 450 | | 02 - | 1 | ● |
| MX | 450 | | 02 - | 1 | ● |
| EN | 530 | | 03 - | 1 | ● |
| MX | 530 | | 03 - | 1 | ● |

YAMAHA

| | | | | | |
|-----|-----|------------------------|---------|---|---|
| YZF | 125 | R | 08 - | 1 | ● |
| TT | 600 | E (Belgarda) | 94 - 95 | 1 | ● |
| TT | 600 | E | 94 - 01 | 1 | ● |
| TT | 600 | K (Belgarda) | 93 - 95 | 1 | ● |
| TT | 600 | K (From 4GV 003404) | 95 - 96 | 1 | ● |
| TT | 600 | R (5CH1 / 5CH2 / 5CH3) | 97 - 02 | 1 | ● |
| TT | 600 | RE (5CH5) | 04 | 1 | ● |
| XT | 660 | Z Ténéré | 08 - | 2 | ● |

Street Sport Racing Enduro MX Off Road Racing ATV

S4

RX3

X59

2353 suite

| Brand | Model | Year | Category | Availability |
|----------------|--------------------------------|---------|----------|--------------|
| KTM | | | | |
| SX | 400 Racing | 00 - 02 | | ● |
| SXC | 400 Tainen Replica | 97 - | | ● |
| EXC | 450 | 03 | | ● |
| EXC | 520 Racing | 00 - 02 | | ● |
| SX | 520 Racing | 00 - 02 | | ● |
| EXC | 525 Racing | 03 | | ● |
| MXC | 525 Desert | 03 - 04 | | ● |
| SX | 525 Racing | 03 | | ● |
| SXC | 540 Tainen Replica | 99 - 00 | | ● |
| EGS | 620 Enduro / EGS-E | 96 - 99 | | ● |
| EGS | 620 Adventure / Rallye / EGS-E | 99 | | ● |
| LC4 | 620 SC Supermoto | 00 | | ● |
| LC4 | 620 Supercompetition | 96 - 00 | | ● |
| LC4 | 620 SX | 95 - 99 | | ● |
| LC4 | 625 SC Supermoto | 02 - 04 | | ● |
| SXC | 625 | 03 - 04 | | ● |
| | 625 SMC | 05 - 06 | | ● |
| LC4 | 640 Adventure R | 00 | | ● |
| LC4 | 640 Adventure | 01 - 02 | | ● |
| LC4 | 640 Adventure (2 sets) | 03 - 07 | | ● |
| LC4 | 640 E Enduro | 99 - | | ● |
| LC4-E | 640 Supermoto | 99 - 06 | | ● |
| SMC | 640 LC4 | 05 | | ● |
| | 640 Duke II | 99 - 07 | | ● |
| LC4 | 660 SM Factory Replica | 02 - | | ● |
| LC4 | 660 Rally | 01 - | | ● |
| | 660 SMC | 03 - 04 | | ● |
| | 660 SMC | 05 - 06 | | ● |
| | 690 SM | 07 - 09 | | ● |
| | 690 SMC | 08 - 10 | | ● |
| | 690 SMR | 07 - 09 | | ● |
| | 690 Duke | 08 - | | ● |
| | 690 Duke R | 10 - | | ● |
| | 690 Enduro | 08 - | | ● |
| | 690 Enduro R | 09 - | | ● |
| LC-8 | 950 Adventure | 02 - | | ● |
| | 950 Duke | 03 - | | ● |
| | 990 Super Duke | 05 - | | ● |
| | 990 Super Duke R | 09 - | | ● |
| MAICO | | | | |
| | 250 Motocross | 99 - | | ● |
| | 250 Enduro | 99 - | | ● |
| | 500 Supermotard | 99 - | | ● |
| | 500 Motocross | 99 - | | ● |
| | 500 Enduro | 99 - | | ● |
| MONTESA | | | | |
| | 80 Cross | 96 - | | ● |
| | 125 | 96 - | | ● |
| | 250 E | 95 - | | ● |
| | 320 Cota | 96 - | | ● |

PRAGA

| | | | | |
|----|-----|--|------|---|
| ED | 250 | | 99 - | ● |
| CD | 610 | | 99 - | ● |

TM

| | | | | |
|--|-----------|----------------------------|---------|---|
| | 80 | Enduro | 96 - 00 | ● |
| | 80/85 | Cross | 96 - 01 | ● |
| | 80/85/100 | Junior Cross (Small Wheel) | 02 - 04 | ● |
| | 80/85/100 | (Big Wheel) | 02 - 04 | ● |
| | 125 | Cross | 95 - 00 | ● |
| | 125 | Enduro | 95 - 00 | ● |
| | 250 | Enduro | 95 - 00 | ● |
| | 250 | Cross | 95 - 00 | ● |
| | 300 | Enduro (2T) | 95 - 00 | ● |
| | 300 | Cross | 95 - 00 | ● |
| | 400 | Cross (4T) | 95 - 00 | ● |
| | 530 | Cross (4T) | 98 - 00 | ● |

VERTEMATI

| | | | | |
|----|-----|---------------|------|---|
| SR | 450 | Motard Racing | 04 - | ● |
| C | 500 | Cross | 02 - | ● |
| E | 500 | Enduro | 02 - | ● |
| S | 501 | E Motard | 04 - | ● |
| S | 501 | Supermoto | 01 - | ● |
| S | 570 | E Motard | 03 - | ● |
| SR | 600 | Motard Racing | 04 - | ● |

VOR

| | | | | |
|----|-----|--|---------|---|
| EN | 400 | | 00 - | ● |
| MX | 400 | | 00 - | ● |
| SM | 400 | | 00 - 02 | ● |
| EN | 450 | | 02 - | ● |
| MX | 450 | | 02 - | ● |
| SM | 450 | | 02 | ● |
| SM | 500 | | 00 - 02 | ● |
| EN | 530 | | 03 - | ● |
| MX | 530 | | 03 - | ● |
| SM | 530 | | 02 - | ● |

YAMAHA

| | | | | |
|-------|-----|------------------------|---------|---|
| WR | 125 | R | 09 - | ● |
| WR | 125 | X Supermotard | 09 - | ● |
| TT | 600 | E | 94 - 01 | ● |
| TT | 600 | K (From 4GV 003404) | 95 - 96 | ● |
| TT | 600 | R (5CH1 / 5CH2 / 5CH3) | 97 - 02 | ● |
| TT | 600 | RE (5CH5) | 04 | ● |
| MT-03 | 660 | | 06 - | ● |
| XT | 660 | R | 04 - | ● |
| XT | 660 | X Supermotard | 04 - | ● |
| XT | 660 | Z Ténéré | 08 - | ● |

Street Sport Racing Enduro MX Off Road Racing ATV

S4 A3+

2360

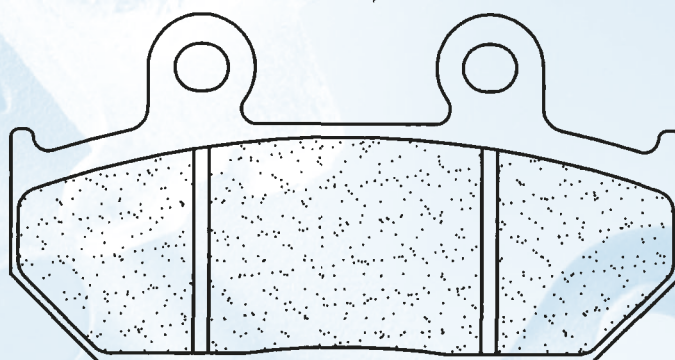
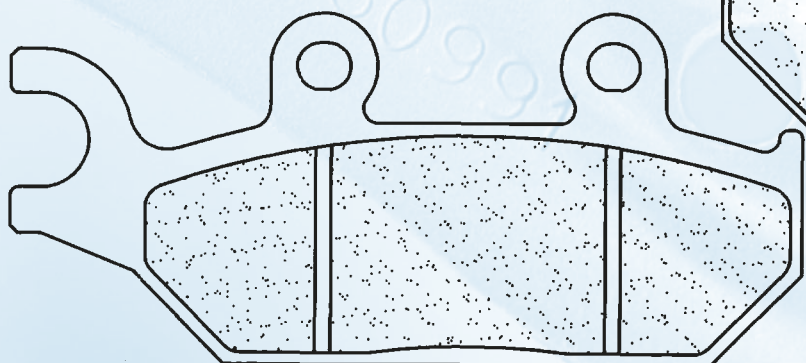

| Dim./Size | Value |
|-----------|---------|
| — | 88 mm |
| ↑ ↓ | 46,1 mm |
| H | 10 mm |

Street Sport Racing Enduro MX Off Road Racing ATV

S4 A3+ XBK5 C59

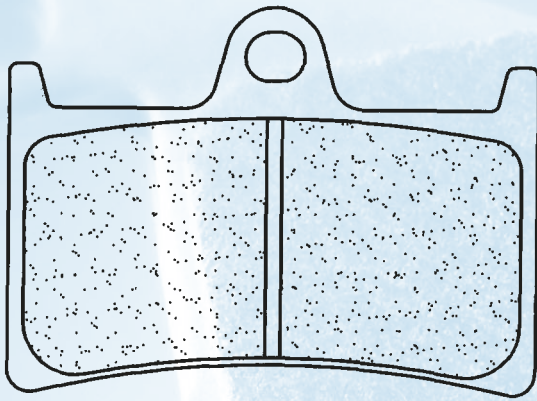

Dim./Size
→ **69,4 mm**
↑ **50,9 mm**
H **8,7 mm**

2361

YAMAHA

| | | | | | |
|-------|------|--------------------------|---------|---|---|
| FZR | 250 | R | 89 - | 2 | ● |
| R1-Z | 250 | | 90 - | 1 | ● |
| TZ | 250 | | 97 - | 2 | ● |
| TZR | 250 | / SP / R / RS / SPR | 89 - 96 | 2 | ● |
| FZR | 400 | RR (3TJ1 / 4DX) | 89 - 92 | 2 | ● |
| FZR | 400 | RR SP (3TJ1 / 4DX) | 91 - 94 | 2 | ● |
| XJR | 400 | | 02 - | 2 | ● |
| FZS | 600 | Fazer | 98 - 03 | 2 | ● |
| FZ6 | 600 | N / Fazer S2 | 07 - 09 | 2 | ● |
| FZ6 | 600 | N / Fazer S2 ABS | 08 | 2 | ● |
| YZF | 600 | R Thunder Cat | 96 - 03 | 2 | ● |
| YZF | 600 | R6 | 99 - 02 | 2 | ● |
| YZF | 600 | R6 | 03 - 05 | 2 | ● |
| YZF | 600 | R6 | 06 - 09 | 2 | ● |
| YZF | 600 | R6 | 10 - | 2 | ● |
| YZF | 750 | R7 (OW02) | 99 - 01 | 2 | ● |
| FZ8 | 800 | | 10 - | 2 | ● |
| FZ8S | 800 | Fazer | 10 - | 2 | ● |
| TDM | 900 | | 02 - | 2 | ● |
| TDM | 900 | ABS | 05 - | 2 | ● |
| FZS | 1000 | Fazer | 01 - 05 | 2 | ● |
| FZ-1 | 1000 | N / Fazer | 06 - | 2 | ● |
| FZ-1 | 1000 | N / Fazer ABS | 08 - | 2 | ● |
| YZF | 1000 | R Thunder Ace | 96 - 01 | 2 | ● |
| YZF | 1000 | R1 | 98 - 01 | 2 | ● |
| YZF | 1000 | R1 | 02 - 03 | 2 | ● |
| YZF | 1000 | R1 / R1 SP | 04 - 06 | 2 | ● |
| BT | 1100 | Bulldog | 02 - 06 | 2 | ● |
| XT | 1200 | Z Super Ténéré (ABS/UBS) | 10 - | 2 | ● |
| FJR | 1300 | | 01 - 02 | 2 | ● |
| FJR | 1300 | / ABS | 03 - 05 | 2 | ● |
| XJR | 1300 | / SP | 99 - 01 | 2 | ● |
| XJR | 1300 | | 02 - 10 | 2 | ● |
| MT-01 | 1700 | (4 piston caliper) | 05 - 06 | 2 | ● |
| XV | 1700 | A / PC Road Star | 02 - 05 | 2 | ● |
| XV | 1900 | A Midnight Star | 06 - | 2 | ● |

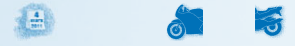

Street Sport Racing Enduro MX Off Road Racing ATV

A3+

YAMAHA

| | | | | | |
|-----|------|-------|---------|---|---|
| GTS | 1000 | / ABS | 93 - 99 | 1 | ● |
|-----|------|-------|---------|---|---|

2362

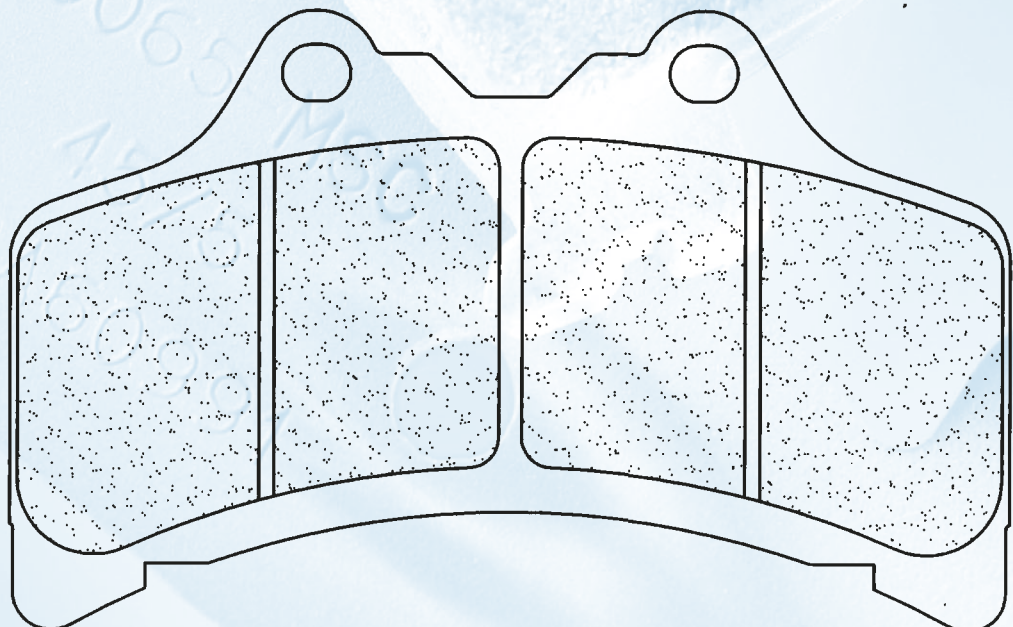

Dim./Size
→ **131,7 mm**
↑ **81,8 mm**
H **9,5 mm**



Street Sport Racing Enduro MX Off Road Racing ATV

A3+ XBK5

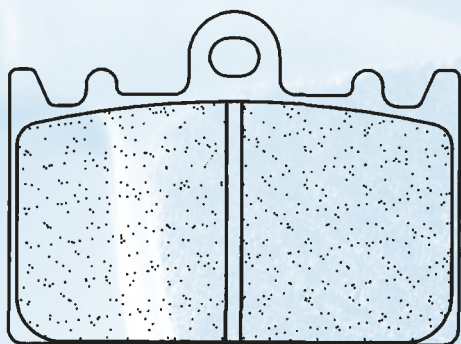

Dim./Size
 → 59 mm
 ↑ 43,6 mm
 H 8 mm

2363

| | | | | | |
|-----------------|-----|------------------------|---------|---|---|
| KAWASAKI | | | | | |
| ZXR | 400 | L1 / L2 / L3 / L4 / L5 | 91 - 02 | 2 | ● |
| SUZUKI | | | | | |
| RGV | 250 | Gamma T (RGVR 250 SP) | 96 - | 2 | ● |

Street Sport Racing Enduro MX Off Road Racing ATV

A3+

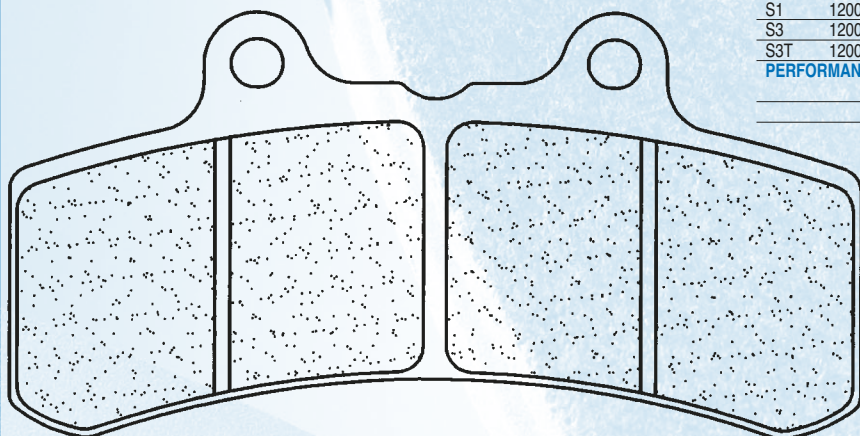

| | | | | | |
|----------------------------|------|----------------------|---------|---|---|
| BUELL | | | | | |
| M2 | 1200 | Cyclone | 94 - 97 | 1 | ● |
| RS | 1200 | | 94 - 97 | 1 | ● |
| S1 | 1200 | Lightning | 94 - 97 | 1 | ● |
| S3 | 1200 | Thunderbolt | 94 - 97 | 1 | ● |
| S3T | 1200 | Thunderbolt | 94 - 97 | 1 | ● |
| PERFORMANCE MACHINE | | | | | |
| | | Caliper 125x6 - Road | | 1 | ● |
| | | Caliper 137x6 - Road | | 1 | ● |

2369

Dim./Size
 → 112 mm
 ↑ 56,3 mm
 H 10,9 mm

Street Sport Racing Enduro MX Off Road Racing ATV

RX3

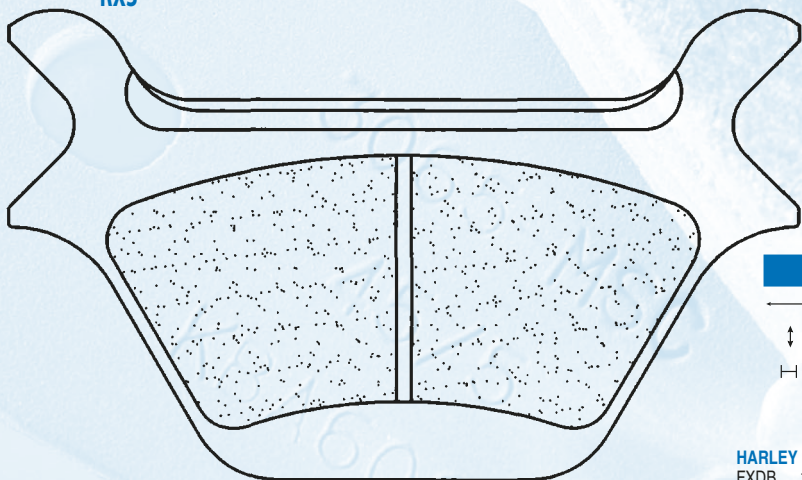

Dim./Size
 → 104 mm
 ↑ 62 mm
 H 9,9 mm

2370

HARLEY DAVIDSON

| | | | | |
|-------|------|--------------------------|---------|---|
| XLH | 883 | Sportster | 87 - 89 | ● |
| XLH | 883 | Sportster | 90 - 99 | ● |
| XLH | 1100 | | 87 - 88 | ● |
| XLH | 1200 | Series | 88 | ● |
| XLH | 1200 | Sportster | 90 - 99 | ● |
| FLHT | 1340 | Electra Glide Classic | 87 - 99 | ● |
| FLHTC | 1340 | Electra Glide Classic | 93 | ● |
| FLSTC | 1340 | Heritage Softail Classic | 90 - 99 | ● |
| FLSTF | 1340 | Fat Boy | 90 - 99 | ● |
| FLSTN | 1340 | Heritage Softail Nost. | 93 - 99 | ● |
| FXDB | 1340 | Dyna Glide Daytona | 91 - 99 | ● |

HARLEY DAVIDSON

| | | | | |
|-------|------|---------------------------|---------|---|
| FXDB | 1340 | Dyna Glide Sturgis | 91 - 99 | ● |
| FXDB | 1340 | Sturgis | 91 - 99 | ● |
| FXE | 1340 | | 82 | ● |
| FXLR | 1340 | Low Rider Custom | 87 - 88 | ● |
| FXLR | 1340 | Low Rider Custom | 93 - 99 | ● |
| FXR | 1340 | Super Glide | 90 - 99 | ● |
| FXR | 1340 | | 87 - 88 | ● |
| FXRS | 1340 | Low Rider Sport | 87 - 99 | ● |
| FXRS | 1340 | Low Rider Sport Edition | 90 - 99 | ● |
| FXRS | 1340 | Low Rider Sport, Convert. | 90 - 99 | ● |
| FXRT | 1340 | Sport Glide | 90 - 99 | ● |
| FXSTC | 1340 | Softail Custom | 88 - 99 | ● |
| FXSTS | 1340 | Springer Softail | 90 - 99 | ● |
| FXTZ | 1340 | Series | 88 | ● |
| FXWG | 1340 | Wide Glide | 82 | ● |
| | 1340 | Dyna Glide Daytona | 91 - | ● |
| | 1340 | Dyna Glide Sturgis | 91 - | ● |

Street Sport Racing Enduro MX Off Road Racing ATV

S4 A3+ RX3 EN10 MX10 X59

| | | | | | | |
|----------------|-----|------------------------|---------|---|---|---|
| AJP | | | | | | |
| MX | 200 | | 09 - | | | ● |
| ALFER | | | | | | |
| MC | 80 | | 87 - | | | ● |
| APRILIA | | | | | | |
| TX | 240 | | 86 - | 1 | ● | ● |
| | 280 | Climber / R | 92 | 1 | ● | ● |
| TX | 311 | | 86 | 1 | ● | ● |
| TX | 312 | M | 88 | 1 | ● | ● |
| TXR | 312 | M | 88 | 1 | ● | ● |
| ATK | | | | | | |
| ATK | 560 | | 87 - 88 | | | ● |
| BENELLI | | | | | | |
| BXK | 125 | | 88 | | | ● |
| BETA | | | | | | |
| SR | 34 | | 89 | 1 | ● | ● |
| ST | 50 | | 97 - | 1 | ● | ● |
| | 50 | Rev | 00 - | 1 | ● | ● |
| | 50 | Super Trial | 92 | 1 | ● | ● |
| | 80 | Rev | 00 - | 1 | ● | ● |
| | 80 | Evo Junior | 10 - | 1 | ● | ● |
| ALP | 125 | 4 Stroke | 00 - 05 | 1 | ● | ● |
| TR | 125 | 34 | 88 | 1 | ● | ● |
| TR | 125 | 34 / 35 | 89 - 90 | 1 | ● | ● |
| TRIAL | 125 | | 97 - | 1 | ● | ● |
| ALP | 200 | 4 Stroke | 00 - 05 | 1 | ● | ● |
| ALP | 240 | | 92 | 1 | ● | ● |
| ALP | 240 | | 96 - | 1 | ● | ● |
| | 240 | Super Trial | 92 - | 1 | ● | ● |
| ALP | 250 | | 92 | 1 | ● | ● |
| ALP | 250 | | 97 - | 1 | ● | ● |
| | 250 | Techno | 96 - 98 | 1 | ● | ● |
| | 250 | Techno | 99 - | 1 | ● | ● |
| | 250 | Zéro | 91 - | 1 | ● | ● |
| ALP | 260 | | 96 - | 1 | ● | ● |
| TR | 260 | Zéro / 34 / 35 | 89 - 92 | 1 | ● | ● |
| | 260 | Zéro | 91 - | 1 | ● | ● |
| BLATA | | | | | | |
| | 125 | Motard | 07 - | | | ● |
| BREMBO | | | | | | |
| | | P 32 A - Road | | 2 | ● | |
| CAGIVA | | | | | | |
| | 50 | Mito | 98 - | | | ● |
| CPI | | | | | | |
| | 50 | Supermoto / Supercross | 03 - | 1 | ● | ● |
| | 125 | Supermoto | 07 - | 1 | ● | ● |
| DERBI | | | | | | |
| | 75 | Sport Coppa | 84 - | 1 | ● | |
| | 75 | GPR | 89 | | | ● |
| | 75 | GPR Sport | | | | ● |
| | 80 | GPR Cup | 04 - | | | ● |
| | 125 | Terra | 07 | 1 | ● | |
| | 125 | GPR | 05 - | | | ● |
| | 125 | GPR Nude | 05 - | | | ● |
| | 125 | GPR Racing | 05 - | | | ● |
| | 125 | Senda X-Treme SM 4T | 04 - | | | ● |
| | 125 | Senda R 4T | 04 - | | | ● |
| FD | | Yumbo | 84 - | 1 | ● | ● |
| FD | | Yumbo Extra | 87 - | 1 | ● | ● |
| FDS | | | 87 - | 1 | ● | ● |
| FDT | | Coppa | 85 | 1 | ● | ● |
| FDT | | | 87 - | 1 | ● | ● |
| FACTORY | | | | | | |
| R12 | 50 | Phantom Agua | 06 - | | | ● |
| R14 | 50 | Phantom Aire | 03 - | 1 | ● | |
| R14 | 50 | Phantom Agua | 04 - | | | ● |
| YR | 125 | | 06 - | | | ● |
| FANTIC | | | | | | |
| | 50 | FC 01 | 98 - | 1 | ● | ● |
| | 50 | Clubman | | 1 | ● | ● |
| | 50 | Trial .5 .7 .9 | 89 - | 1 | ● | ● |
| | 80 | Clubman | | 1 | ● | ● |
| | 125 | Clubman | | 1 | ● | ● |
| | 125 | Cruiser | 98 - | | | ● |
| | 250 | Coach | 91 - | | | ● |
| | 250 | C@sta | 98 - | 1 | ● | ● |
| | 250 | Clubman | | 1 | ● | ● |
| | 250 | K Roo | 93 - | 1 | ● | ● |
| | 250 | Section | 96 - | 1 | ● | ● |
| | 305 | Trial | 89 | 1 | ● | ● |
| | 307 | Trial | 91 - | 1 | ● | ● |
| GAC | | | | | | |
| | | New T.T. | 87 | 1 | ● | |
| GARELLI | | | | | | |
| | 50 | Sahel | 91 - | | | ● |
| GAS GAS | | | | | | |
| TXT | 50 | Boy | 04 - | 1 | ● | ● |
| JT | 125 | R | 96 | 1 | ● | ● |
| JT | 125 | X | 97 - | 1 | ● | ● |

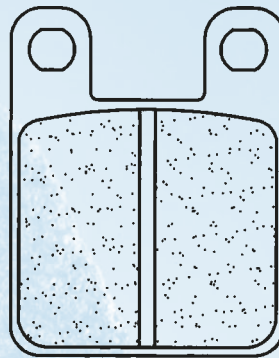

2377

Dim./Size
 ← 36 mm
 ↓ 45,5 mm
 H 6 mm

GAS GAS

| | | | | | | |
|-----|-----|------------------|---------|---|---|---|
| | 125 | Delta | 91 - | 1 | ● | |
| | 125 | Trial | 91 - | 1 | ● | |
| | 125 | Pampera | 97 - 03 | 1 | ● | ● |
| JT | 160 | R | 96 | 1 | ● | ● |
| TX | 200 | | 97 - | 1 | ● | ● |
| | 200 | Pampera | 99 - | 1 | ● | ● |
| JT | 250 | Contact | 93 - 94 | 1 | ● | ● |
| JT | 250 | R Tarres Replica | 96 | 1 | ● | ● |
| JT | 250 | X | 97 - | 1 | ● | ● |
| TXT | 250 | Trial | 89 - | 1 | ● | ● |
| | 250 | Pampera | 96 - 02 | 1 | ● | ● |
| JT | 270 | X | 97 - | 1 | ● | ● |
| TX | 270 | Contact | 97 - | 1 | ● | ● |
| JT | 320 | X | 97 - | 1 | ● | ● |
| TX | 320 | Contact | 97 - | 1 | ● | ● |
| | 325 | Halley PXC | | 1 | ● | ● |
| | 327 | Trial | | 1 | ● | ● |
| | 327 | Contact | | 1 | ● | ● |
| JT | 370 | R 37 | 96 | 1 | ● | ● |
| | 370 | Pampera | 96 - | 1 | ● | ● |
| | 370 | Pampera | 98 - | 1 | ● | ● |

GILERA

| | | | | | | |
|------------|-----|-------------|---------|---|---|---|
| | 125 | GSM | 00 - | 1 | ● | ● |
| HRD | | | | | | |
| | 125 | Supermotard | 00 - 02 | | | ● |
| | 125 | Trail | 00 - 02 | | | ● |

HUSQUEVARNA

| | | | | | | |
|-----|----|-----------|------|---|---|--|
| | 50 | Racing | 98 - | 1 | ● | |
| WRS | 50 | | 98 - | 1 | ● | |
| | 50 | Husky Boy | 01 - | 1 | ● | |

JCM

| | | | | | | |
|--|-----|--------|----|---|---|---|
| | 125 | Europa | 89 | 1 | ● | ● |
| | 125 | SR | 89 | 1 | ● | ● |
| | 240 | Europa | 89 | 1 | ● | ● |
| | 240 | SR | 89 | 1 | ● | ● |
| | 325 | Europa | 89 | 1 | ● | ● |
| | 325 | SR | 89 | 1 | ● | ● |

KTM

| | | | | | | |
|----|----|--|---------|---|---|--|
| SX | 60 | | 99 - | 1 | ● | |
| SX | 65 | | 00 - 01 | 1 | ● | |

MH (MOTORHISPANIA)

| | | | | | | |
|-----|-----|--------------|------|---|---|---|
| RYZ | 125 | Arena Enduro | 05 - | 1 | ● | ● |
|-----|-----|--------------|------|---|---|---|

MONTESA

| | | | | | | |
|----|-----|------------|---------|---|---|---|
| | 125 | Cota | 88 | 1 | ● | ● |
| | 260 | Evasion | 92 | 1 | ● | ● |
| | 304 | Cota | 88 | 1 | ● | ● |
| | 307 | Cota | 89 | 1 | ● | ● |
| | 307 | Cota Trial | 88 - | 1 | ● | ● |
| | 309 | Cota | 89 - | 1 | ● | ● |
| | 310 | Cota | 89 - | 1 | ● | ● |
| | 311 | Cota Trial | 92 | 1 | ● | ● |
| | 314 | Cota | 95 - | 1 | ● | ● |
| | 315 | Cota R | 97 - | 1 | ● | ● |
| | 335 | Cota | 87 - 91 | 1 | ● | ● |
| M7 | 360 | Enduro | 85 | 1 | ● | ● |

MORBIDELLI

| | | | | | | |
|--|-----|----|--|---|---|---|
| | 125 | cc | | 2 | ● | ● |
|--|-----|----|--|---|---|---|

PERFORMANCE MACHINE

| | | | | | |
|--|--|------------------------------------|---|---|--|
| | | Caliper 125x2 = 0052-2100 - Road | 1 | ● | |
| | | Caliper 125x4S = 0052-2200 - Road | 2 | ● | |
| | | Caliper 125x4SL = 0052-2300 - Road | 2 | ● | |

RIEJU

| | | | | | | |
|----|-----|--------------------|---------|---|---|---|
| MR | 80 | Enduro | 87 | 1 | ● | |
| MR | 80 | Cross | 87 | 1 | ● | |
| | 125 | MRX | 02 - 08 | | | ● |
| | 125 | NKD | 06 - 07 | | | ● |
| | 125 | RS2 (AJP Caliper) | 06 - 10 | | | ● |
| | 125 | SMX | 02 - 07 | | | ● |
| | 125 | SMX (Cast Wheel) | 07 - 08 | | | ● |
| | 125 | Tango | 06 - 10 | | | ● |
| | 125 | Tango pro | 07 - 10 | | | ● |
| | 250 | Tango (All models) | 08 - 10 | | | ● |

2377 suite

| SHERCO | | | | | |
|--------|------------------------|---------|---|---|---|
| 80 | Trial 0.8 (2T) | 01 - 04 | 1 | ● | |
| 125 | Trial 1.25 (2T) | 99 - 05 | 1 | ● | ● |
| 125 | City Corp (All models) | 03 - 07 | | | ● |
| 200 | Trial 2.0 (2T) | 99 - 05 | 1 | ● | ● |
| 250 | Trial 2.5 (2T) | 99 - 05 | 1 | ● | ● |
| 290 | Trial 2.9 (2T) | 99 - 05 | 1 | ● | ● |
| SIMSON | | | | | |
| 125 | SM | 01 - | | | ● |
| SUZUKI | | | | | |
| DR | 50 Big | 89 - | 1 | ● | |
| RMX | 50 | 98 - | 1 | ● | ● |
| YAMAHA | | | | | |
| TZR | 50 | 03 - 08 | | | ● |
| TY | 250 R | 91 - 92 | 1 | ● | |
| TY | 250 R | 93 - 94 | 1 | ● | ● |
| TY-Z | 250 R | 93 - 96 | 1 | ● | ● |

| Street | Sport | Racing | Enduro | MX | Off Road Racing | ATV |
|--------|-------|--------|--------|----|-----------------|-----|
|--------|-------|--------|--------|----|-----------------|-----|

RX3

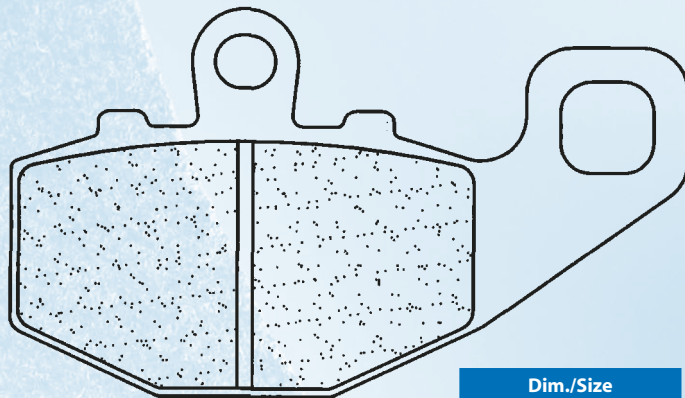
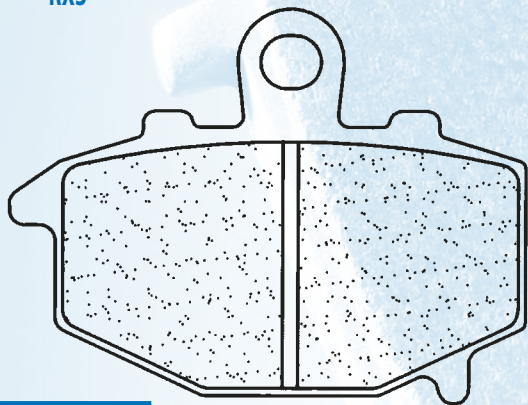

2381

| Dim./Size | |
|-----------|---------|
| → | 89,2 mm |
| ↑ | 51 mm |
| H | 9,7 mm |

| Dim./Size | |
|-----------|--------|
| → | 68 mm |
| ↑ | 51 mm |
| H | 9,7 mm |

| KAWASAKI | | | | | |
|----------|----------------------|---------|--|--|---|
| ZZR | 500 (Austria) | 93 - | | | ● |
| ZR | 550 B4 / B5 / Zephyr | 93 - 99 | | | ● |
| ZR | 550 Zephyr Germany | 93 - | | | ● |
| ZX6-R | 600 E1-E5 Ninja | 93 - 97 | | | ● |
| ZX6-R | 600 Ninja F1 / F2 | 95 - 97 | | | ● |
| ZX6-R | 600 Ninja (ZX600G) | 98 - 02 | | | ● |
| ZX6-R | 600 Ninja (Rad.Cal) | 07 - | | | ● |
| ZX6-RR | 600 Ninja (Rad.Cal) | 03 - 06 | | | ● |
| ZX6-R | 636 Ninja | 02 | | | ● |

| KAWASAKI | | | | | |
|----------|----------------------|---------|--|--|---|
| ZX6-R | 636 Ninja (Rad.Cal) | 03 - 06 | | | ● |
| ZZR | 600 | 93 - 95 | | | ● |
| | 650 Versys | 06 - | | | ● |
| ER-6 | 650 N/F | 06 - | | | ● |
| Z | 750 | 04 - 06 | | | ● |
| Z | 750 S | 05 - 06 | | | ● |
| ZX9-R | 900 Ninja | 94 - 95 | | | ● |
| ZX9-R | 900 Ninja / C Ninja | 96 - 01 | | | ● |
| ZX9-R | 900 Ninja | 02 - 03 | | | ● |
| Z | 1000 | 03 - 06 | | | ● |
| ZX10-R | 1000 Ninja (Rad.Cal) | 04 - 07 | | | ● |
| ZX10-R | 1000 Ninja (Rad.Cal) | 08 - 10 | | | ● |
| ZX10-R | 1000 Ninja (Rad.Cal) | 11 - | | | ● |
| GPZ | 1100 | 95 - 96 | | | ● |
| GPZ | 1100 ABS | 97 - | | | ● |

| Street | Sport | Racing | Enduro | MX | Off Road Racing | ATV |
|--------|-------|--------|--------|----|-----------------|-----|
|--------|-------|--------|--------|----|-----------------|-----|

S4 A3+ RX3

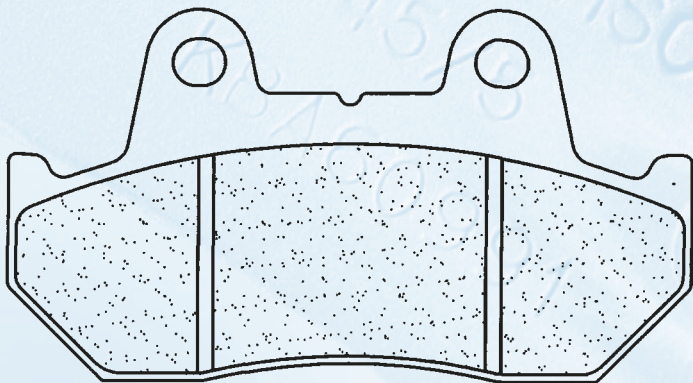



| Dim./Size | |
|-----------|-------|
| → | 90 mm |
| ↑ | 49 mm |
| H | 9 mm |

2382



| HONDA | | | | | |
|-------|-------------------|---------|---|--|---|
| CB | 125 T Superdream | 82 - | 1 | | ● |
| CBX | 125 F | 84 - 88 | 1 | | ● |
| CBX | 250 S | 88 - | 1 | | ● |
| NS | 250 R | 85 | 2 | | ● |
| CM | 400 C | 81 | 1 | | ● |
| NS | 400 R | 85 - 87 | 2 | | ● |
| VF | 400 Integra | 86 - | 1 | | ● |
| CB | 450 SC Nighthawk | 83 - 86 | 1 | | ● |
| CX | 500 | 81 - | 2 | | ● |
| CX | 500 Euro | 82 - | 2 | | ● |
| CX | 500 Turbo | 82 - | | | ● |
| GL | 500 I | 81 - 82 | 2 | | ● |
| GL | 500 | 82 | 2 | | ● |
| CX | 650 E | 83 - | 2 | | ● |
| VF | 700 C Magna | 85 - 86 | 2 | | ● |
| VF | 700 F Interceptor | 84 - 85 | 2 | | ● |
| CB | 750 SC | 82 - 83 | 2 | | ● |
| XLV | 750 R | 86 - | 1 | | ● |
| CB | 900 F / F2 | 81 - 84 | 2 | | ● |
| CBX | 1000 | 81 - 82 | 2 | | ● |
| VF | 1100 C | 83 - 86 | 2 | | ● |
| VF | 1100 S | 84 - 85 | 2 | | ● |

| | | | | | | |
|--------|-------|--------|--------|----|--------------------|-----|
| Street | Sport | Racing | Enduro | MX | Off Road Racing | ATV |
| S4 | A3+ | XBK5 | C59 | | | |

2383

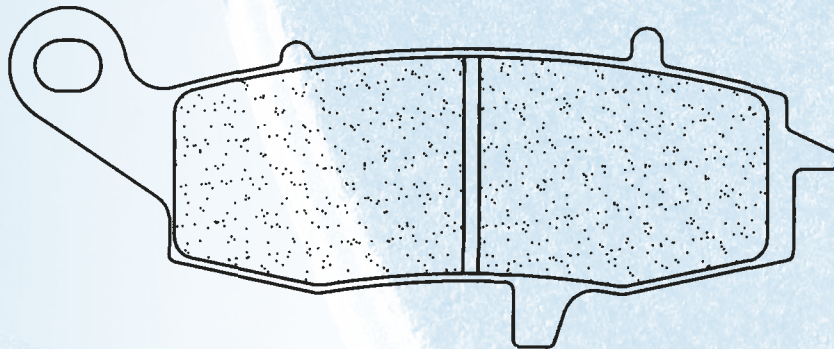
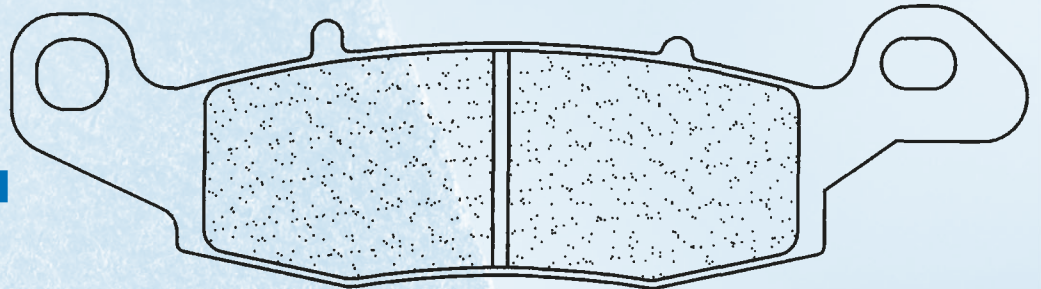
Dim./Size
 **135,5 mm**
 **37,4 mm**
 **8,3 mm**



Dim./Size
 **109,3 mm**
 **44,4 mm**
 **8,3 mm**

KAWASAKI

| | | | | | |
|------|------|--------------------------|---------|-----|---|
| ER-5 | 500 | | 01 - | 1 | ● |
| | 650 | Versys | 06 - | L 1 | ● |
| ER-6 | 650 | N/F | 06 - | L 1 | ● |
| KL | 650 | C1 (KLR) | 95 - | 1 | ● |
| KLR | 650 | C1 | 98 - | 1 | ● |
| Z | 750 | S | 05 - 06 | L 1 | ● |
| Z | 750 | | 04 - 06 | L 1 | ● |
| ZR | 750 | Zephyr | 96 - 98 | L 1 | ● |
| ZR-7 | 750 | S | 01 - 03 | L 1 | ● |
| ZR-7 | 750 | | 99 - 03 | L 1 | ● |
| VN | 800 | Classic | 98 - | 1 | ● |
| VN | 800 | Drifter / Vulcan Drifter | 99 - 02 | 1 | ● |
| VN | 900 | Custom | 07 - | 1 | ● |
| VN | 900 | Vulcan / Vulcan Classic | 06 - | 1 | ● |
| KLV | 1000 | | 04 - | L 1 | ● |
| GPZ | 1100 | ABS | 97 - | L 1 | ● |
| GPZ | 1100 | | 95 - 96 | L 1 | ● |
| ZR | 1100 | Zephyr | 97 - | L 1 | ● |
| VN | 1500 | Classic | 96 - | 1 | ● |
| VN | 1500 | Classic Fi | 00 - | 1 | ● |
| VN | 1500 | Classic Tourer | 98 - | L 1 | ● |
| VN | 1500 | Classic Tourer Fi | 00 - | L 1 | ● |
| VN | 1500 | Drifter | 99 - 02 | 1 | ● |
| VN | 1500 | Vulcan Nomad | 98 - | L 1 | ● |
| VN | 1500 | Vulcan Nomad Fi | 00 - | L 1 | ● |
| VN | 1600 | Classic | 03 - | L 1 | ● |
| VN | 1700 | Classic | 09 - | L 1 | ● |
| VN | 1700 | Classic Tourer | 09 - | L 1 | ● |

SUZUKI

| | | | | | |
|-------|------|----------------------------|---------|-----|---|
| GSF | 250 | VS / S Bandit | 97 - | 1 | ● |
| TU | 250 | Grass tracker / Big boy | 00 - 01 | 1 | ● |
| GSF | 600 | S / N Bandit | 00 - 04 | L 1 | ● |
| GSX-F | 600 | FW/FX/FY/FK1 to FK6 | 98 - 06 | L 1 | ● |
| DL | 650 | V-Strom | 04 - | L 1 | ● |
| DL | 650 | V-Strom ABS | 07 - | L 1 | ● |
| GSF | 650 | Bandit / Bandit S | 05 - 06 | L 1 | ● |
| GSF | 650 | Bandit ABS / Bandit S ABS | 05 - 06 | L 1 | ● |
| SFV | 650 | Gladius | 09 - | L 1 | ● |
| SV | 650 | N / S | 99 - 02 | L 1 | ● |
| SV | 650 | N / S | 03 - | L 1 | ● |
| SV | 650 | N ABS / S ABS | 07 - | L 1 | ● |
| GSX | 750 | W/X/Y/K1 Inazuma | 97 - 03 | L 1 | ● |
| GSX-F | 750 | FW/FX/FY/FK1 to FK6 | 98 - 06 | L 1 | ● |
| DR | 800 | ST Big | 96 - | 1 | ● |
| DL | 1000 | V-Strom K2-K9 | 02 - 09 | L 1 | ● |
| GSX | 1100 | G | 96 - | L 1 | ● |
| VL | 1500 | Intruder Legendary Classic | 02 - 03 | L 1 | ● |
| C | 1500 | Intruder | 05 - 09 | L 1 | ● |
| C90 | 1500 | Boulevard | 05 - 09 | L 1 | ● |
| M | 1500 | Intruder | 09 - | L 1 | ● |

Street Sport Racing Enduro MX Off Road Racing ATV

S4 A3+ RX3 XBK5 C59

2384

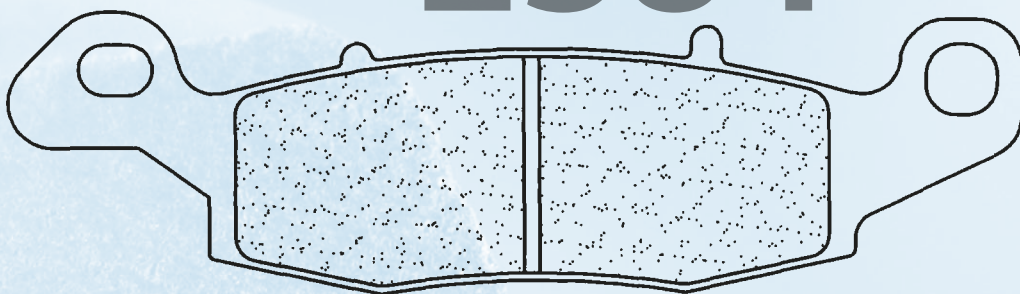

Dim./Size
 — 135,5 mm
 ↑ 37,4 mm
 H 8,3 mm

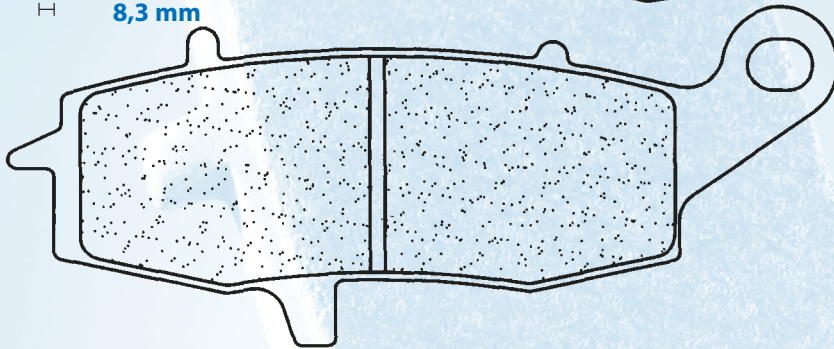

Dim./Size
 — 109,3 mm
 ↑ 44,4 mm
 H 8,3 mm

KAWASAKI

| | | | | | | | | |
|------|------|--------------------------|---------|---|---|---|---|---|
| ER-6 | 650 | N/F | 06 - | R | 1 | ● | | |
| W | 650 | | 99 - | | 1 | ● | | |
| | 650 | Versys | 06 - | R | 1 | ● | | |
| Z | 750 | S | 05 - 06 | R | 1 | ● | | |
| Z | 750 | | 04 - 06 | R | 1 | ● | | |
| ZR | 750 | Zephyr | 96 - 98 | R | 1 | ● | | |
| ZR-7 | 750 | | 99 - 03 | R | 1 | ● | | ● |
| ZR-7 | 750 | S | 01 - 03 | R | 1 | ● | ● | ● |
| VN | 800 | Drifter / Vulcan Drifter | 99 - 02 | | | ● | | ● |
| VN | 900 | Custom | 07 - | | | ● | | ● |
| VN | 900 | Vulcan / Vulcan Classic | 06 - | | | ● | | ● |
| KLV | 1000 | | 04 - | R | 1 | ● | | ● |
| GPZ | 1100 | | 95 - 96 | R | 1 | ● | | ● |
| GPZ | 1100 | ABS | 97 - | R | 1 | ● | | ● |
| ZR | 1100 | Zephyr | 97 - | R | 1 | ● | | ● |
| VN | 1500 | Classic Fi | 00 - | | | ● | | ● |
| VN | 1500 | Classic Tourer | 98 - | R | 1 | ● | | ● |
| VN | 1500 | Classic Tourer Fi | 00 - | R | 1 | ● | | ● |
| VN | 1500 | Drifter | 99 - 02 | | | ● | | ● |
| VN | 1500 | Mean Streak | 02 - 03 | | | ● | | ● |
| VN | 1500 | Vulcan Nomad | 98 - | R | 1 | ● | | ● |
| VN | 1500 | Vulcan Nomad Fi | 00 - | R | 1 | ● | | ● |
| VN | 1600 | Classic | 03 - | R | 1 | ● | | ● |
| VN | 1600 | Mean Streak | 04 | | | ● | | ● |
| VN | 1600 | Mean Streak | 05 - | | | ● | | ● |
| VN | 1700 | Classic | 09 - | R | 1 | ● | | ● |
| VN | 1700 | Classic Tourer | 09 - | R | 1 | ● | | ● |
| VN | 1700 | Voyager | 09 - | | | ● | | ● |
| VN | 2000 | / Vulcan | 04 - | | | ● | | ● |

SUZUKI

| | | | | | | | | |
|-----|-----|---------|---------|--|---|---|--|--|
| RV | 125 | Van Van | 02 - 10 | | 1 | ● | | |
| RV | 200 | Van Van | 02 - 03 | | 1 | ● | | |
| GSX | 250 | FX | 02 - 05 | | 1 | ● | | |
| GS | 500 | F | 04 - 08 | | 1 | ● | | |

SUZUKI

| | | | | | | | | |
|-------|------|------------------------------------|---------|---|---|---|--|---|
| GS | 500 | E | 96 - 03 | | 1 | ● | | |
| GSF | 600 | S / N Bandit | 00 - 04 | R | 1 | ● | | |
| GSX-F | 600 | FW/FX/FY/FK1 to FK6 | 98 - 06 | R | 1 | ● | | |
| DL | 650 | V-Strom | 04 - | R | 1 | ● | | |
| DL | 650 | V-Strom ABS | 07 - | R | 1 | ● | | |
| GSF | 650 | Bandit / Bandit S | 05 - 06 | R | 1 | ● | | |
| GSF | 650 | Bandit ABS / Bandit S ABS | 05 - 06 | R | 1 | ● | | |
| SFV | 650 | Gladius | 09 - | R | 1 | ● | | |
| SV | 650 | N / S | 99 - 02 | R | 1 | ● | | |
| SV | 650 | N / S | 03 - | R | 1 | ● | | |
| SV | 650 | N ABS / S ABS | 07 - | R | 1 | ● | | |
| XF | 650 | Freewind | 97 - 02 | | 1 | ● | | |
| GSX | 750 | W/X/Y/K1 Inazuma | 97 - 03 | R | 1 | ● | | |
| GSX-F | 750 | FW/FX/FY/FK1 to FK6 | 98 - 06 | R | 1 | ● | | |
| C | 800 | Intruder (VL 800 K5-K9/L0) (C800) | 05 - | | 1 | ● | | |
| C90 | 800 | Boulevard (VL 800 K5-K9/L0) (C800) | 05 - | | 1 | ● | | ● |
| M | 800 | Intruder (VZ 800 K5-K9/L0) (M800) | 05 - | | 1 | ● | | |
| M | 800 | Intruder Z (VZ 800 K9Z) (M800) | 09 - | | 1 | ● | | |
| M50 | 800 | Boulevard | 05 - | | 1 | ● | | |
| S50 | 800 | Boulevard | 05 - | | 1 | ● | | |
| VL | 800 | Intruder Volusia K1/K2/K3/K4 | 01 - 04 | | 1 | ● | | |
| VZ | 800 | Marauder | 97 - 04 | | 1 | ● | | |
| DL | 1000 | V-Strom K2-K9 | 02 - 09 | R | 1 | ● | | |
| GSX | 1100 | G | 96 - | R | 1 | ● | | |
| C | 1500 | Intruder | 05 - 09 | R | 1 | ● | | |
| C90 | 1500 | Boulevard | 05 - 09 | R | 1 | ● | | |
| M | 1500 | Intruder | 09 - | R | 1 | ● | | ● |
| VL | 1500 | Intruder Legendary Classic | 02 - 03 | R | 1 | ● | | |
| M | 1600 | Intruder | 05 - | | | ● | | |
| M95 | 1600 | Boulevard | 05 - | | | ● | | |
| VZ | 1600 | Marauder | 04 | | | ● | | |
| C | 1800 | R Intruder / RT Intruder | 08 - | | | ● | | |
| M | 1800 | R Intruder | 06 - 09 | | | ● | | |
| M | 1800 | R2 Intruder | 08 - 09 | | | ● | | |
| M | 1800 | RZ | 07 - 10 | | | ● | | |

Street Sport Racing Enduro MX Off Road Racing ATV

RX3

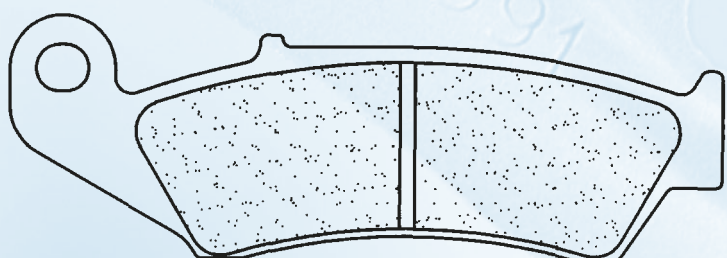

Dim./Size
 — 94 mm
 ↑ 32 mm
 H 10 mm

2385

HONDA

| | | | | | | | | |
|-----|-----|-----------|---------|--|--|---|--|--|
| VFR | 400 | R NC24 | 87 - | | | ● | | |
| RVF | 400 | RR (NC35) | 90 - 96 | | | ● | | |
| VTR | 400 | R | 90 | | | ● | | |
| VFR | 750 | R (RC 30) | 88 - 93 | | | ● | | |
| RVF | 750 | RR (RC45) | 94 - | | | ● | | |

Street Sport Racing Enduro MX Off Road Racing ATV

A3+

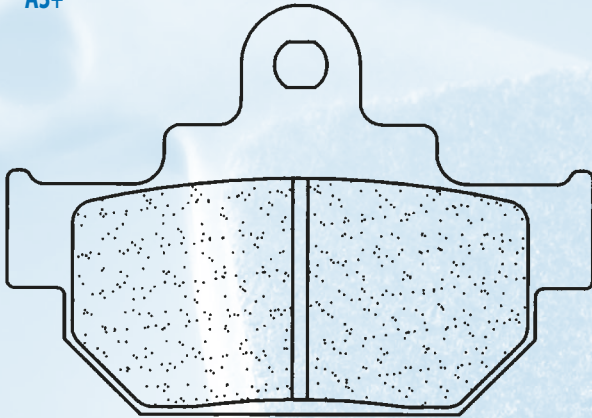

SUZUKI

| | | | | | |
|----|-----|-------------------------|---------|---|---|
| DR | 500 | S | 89 - | 1 | ● |
| DR | 600 | RG/RH/RJ (SN41A) Djebel | 86 - 88 | 1 | ● |
| DR | 600 | RK (SN41A) Djebel | 89 | 1 | ● |
| DR | 600 | SF/SG/SH/SJ/SK (SN41A) | 85 - 89 | 1 | ● |
| SP | 600 | F | 85 - 87 | 1 | ● |

2386

Dim./Size

→ 76,8 mm
↑ 53,8 mm
H 9,5 mm

Street Sport Racing Enduro MX Off Road Racing ATV

S4 A3+

MX10 X59

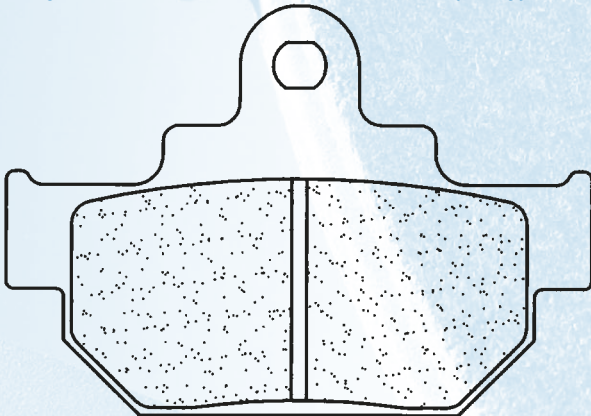

Dim./Size

→ 76,8 mm
↑ 53,8 mm
H 7,1 mm

2387

MAICO

| | | | | | | |
|----|-----|-----------|------|---|---|---|
| GM | 250 | Star | 86 - | 1 | ● | ● |
| GP | 250 | E | 87 - | 1 | ● | ● |
| GP | 250 | Motocross | 87 - | 1 | ● | ● |
| GP | 400 | E | 87 - | 1 | ● | ● |
| GP | 400 | Motocross | 87 - | 1 | ● | ● |
| GM | 500 | Star | 86 - | 1 | ● | ● |
| GP | 500 | Motocross | 87 - | 1 | ● | ● |
| GP | 500 | E | 87 - | 1 | ● | ● |
| GP | 550 | | 87 - | 1 | ● | ● |

SUZUKI

| | | | | | | |
|-----|-----|---------------------------------|---------|---|---|---|
| GZ | 125 | Marauder | 98 - 10 | 1 | ● | ● |
| RM | 125 | F / G | 85 - 86 | 1 | ● | ● |
| TU | 125 | XT / Super Classic | 99 - | 1 | ● | ● |
| VL | 125 | Intruder LC | 00 - 08 | 1 | ● | ● |
| GZ | 250 | / Marauder | 99 - 08 | 1 | ● | ● |
| RM | 250 | F / G | 85 - 86 | 1 | ● | ● |
| TU | 250 | XV / XW | 92 - 97 | 1 | ● | ● |
| TU | 250 | S/T/XS/XT/X-ST/XSV/XT-W (Volty) | 97 - 00 | 1 | ● | ● |
| VL | 250 | Intruder | 00 - 07 | 1 | ● | ● |
| LS | 400 | Savage | 87 - | 1 | ● | ● |
| RM | 500 | | 85 - 86 | 1 | ● | ● |
| LS | 650 | P Savage | 86 - 04 | 1 | ● | ● |
| S40 | 650 | Boulevard | 05 - | 1 | ● | ● |

Street Sport Racing Enduro MX Off Road Racing ATV

S4 RX3

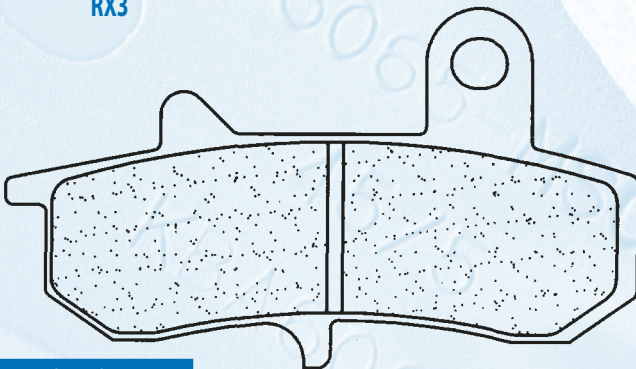

Dim./Size

→ 83,4 mm
↑ 47,8 mm
H 9,8 mm

Dim./Size

→ 99,3 mm
↑ 39 mm
H 7,4 mm

2388

SUZUKI

| | | | | |
|----|-----|------------------------|---------|---|
| RG | 125 | F Gamma | 92 - 96 | ● |
| RG | 125 | Wolf | 92 - 94 | ● |
| RG | 200 | Gamma | 91 - | ● |
| TV | 200 | Wolf | 92 - | ● |
| DR | 600 | RK (SN41A) Djebel | 89 | ● |
| DR | 650 | R (SP41A) / RS (SP42A) | 90 - 91 | ● |
| DR | 650 | RSE (SP43A) | 91 - 95 | ● |
| DR | 650 | R (SP44A/B) | 92 - 93 | ● |
| DR | 750 | SK Big | 89 - 90 | ● |
| DR | 800 | SL (SR43A) Big | 90 | ● |

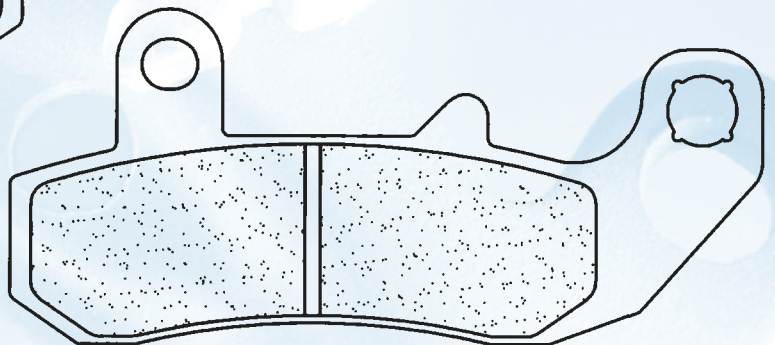

Street Sport Racing Enduro MX Off Road Racing ATV

S4 A3+ RX3

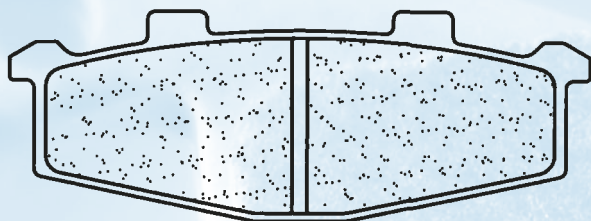

Dim./Size

76,4 mm

27,5 mm

9,7 mm

2389

Dim./Size

106,2 mm

38,9 mm

7,4 mm

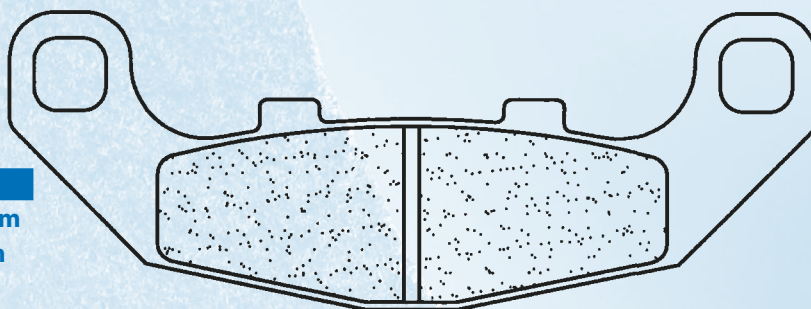

KAWASAKI

| | | | | | |
|------|-----|------------------|---------|---|---|
| EX | 250 | R F2-F17 Ninja | 88 - 07 | | ● |
| GPX | 250 | R | 88 - | | ● |
| KR1 | 250 | | 88 - 89 | 2 | ● |
| KR1 | 250 | S | 90 | | ● |
| ZXR | 250 | R | 89 | 2 | ● |
| ZXR | 250 | | 90 | 2 | ● |
| GPX | 400 | | 87 - | 2 | ● |
| GPZ | 400 | R | 89 - | 2 | ● |
| ZR | 400 | Xanthus (D1) | 92 - 95 | 2 | ● |
| ZX-4 | 400 | | 88 - 89 | 2 | ● |
| EX | 500 | E1-E3 | 94 - 96 | 1 | ● |
| GPZ | 500 | S E1-E10 | 94 - 04 | 2 | ● |
| ZR | 550 | B1 / B3 / Zephyr | 90 - 92 | | ● |
| ZR | 550 | Zephyr Germany | 93 - | 2 | ● |
| ZR | 750 | Zephyr | 91 - 95 | | ● |

SUZUKI

| | | | | | |
|-----|------|-------------------------|---------|--|---|
| RGV | 250 | Gamma M / N / P / R / S | 91 - 95 | | ● |
| RGV | 250 | Gamma T (RGVR 250 SP) | 96 - | | ● |
| GSX | 1100 | G | 94 - 95 | | ● |

Street Sport Racing Enduro MX Off Road Racing ATV

RX3



SUZUKI

| | | | | | |
|----|-----|---------------|---------|--|---|
| RF | 900 | RR / RS / RS2 | 94 - 95 | | ● |
|----|-----|---------------|---------|--|---|

2390

Dim./Size

56,3 mm

52,5 mm

8,7 mm

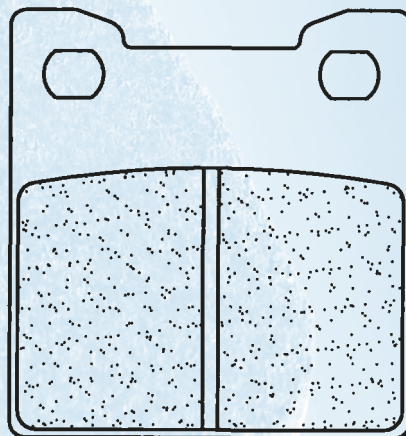

Street Sport Racing Enduro MX Off Road Racing ATV

S4 A3+

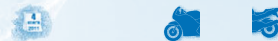

YAMAHA

| | | | | | |
|-----|------|---------------------|---------|---|---|
| FZX | 250 | Zeal | 91 - 92 | 1 | ● |
| SRV | 250 | (4DN1-6) | 92 - 97 | 1 | ● |
| XJ | 400 | S Diversion | 91 - | 1 | ● |
| XVS | 400 | Drag Star | 96 - | 1 | ● |
| XV | 535 | Virago / S Virago | 95 - 03 | 1 | ● |
| XJ | 600 | N / S Diversion | 92 - 97 | 1 | ● |
| XVS | 650 | Drag Star | 97 - 04 | 1 | ● |
| XVS | 650 | A Drag Star Classic | 98 - 07 | 1 | ● |
| XV | 750 | Virago | 94 - 97 | 2 | ● |
| XJ | 900 | S Diversion | 94 - 03 | 2 | ● |
| XVS | 950 | A Midnight Star | 09 - | 1 | ● |
| XV | 1100 | Virago | 94 - 98 | 2 | ● |
| XVZ | 1300 | TF Venture Star | 99 - 01 | 2 | ● |
| XV | 1600 | A Wild Star | 99 - 04 | 2 | ● |

2391

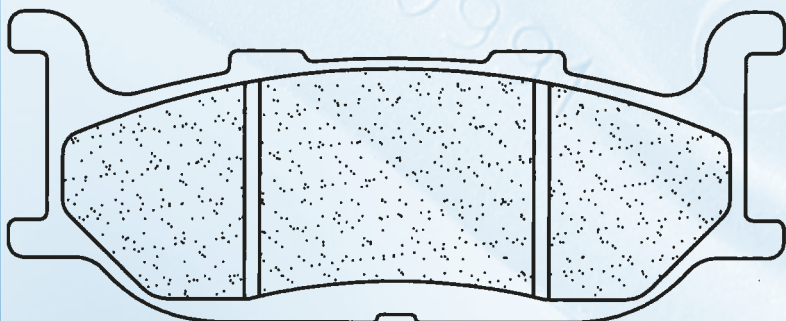

Dim./Size

102,1 mm

40,9 mm

10 mm

Street Sport Racing Enduro MX Off Road Racing ATV

S4 A3+

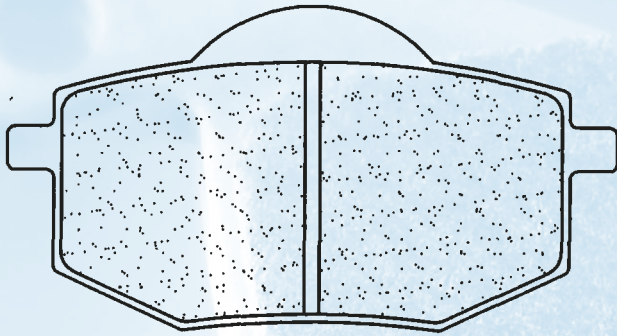

YAMAHA

| | | | | | |
|----|-----|--------|---------|---|---|
| XV | 250 | Virago | 91 - 92 | 1 | ● |
| XV | 400 | Virago | 88 - | 1 | ● |
| XV | 535 | Virago | 88 - 94 | 1 | ● |

Dim./Size

→ 79 mm
↑↓ 42,5 mm
H 10 mm

2392

Street Sport Racing Enduro MX Off Road Racing ATV

S4 A3+

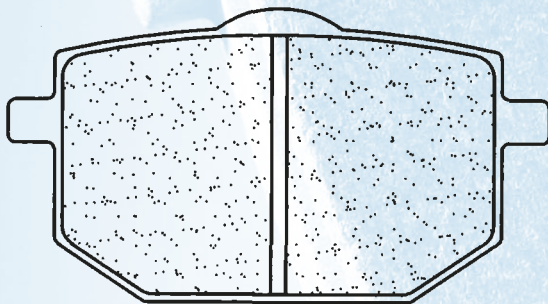

MOTO GUZZI

| | | | | | |
|---------------|-----|----------|---------|---|---|
| NTX | 750 | | 90 - | 1 | ● |
| YAMAHA | | | | | |
| XT | 600 | | 87 - 89 | 1 | ● |
| XT | 600 | Ténéré | 85 - 88 | 1 | ● |
| XT | 600 | Z Ténéré | 88 - 90 | 1 | ● |

Dim./Size

→ 71 mm
↑↓ 38,7 mm
H 10 mm

2393

Street Sport Racing Enduro MX Off Road Racing ATV

S4 A3+ RX3 XBK5 C59

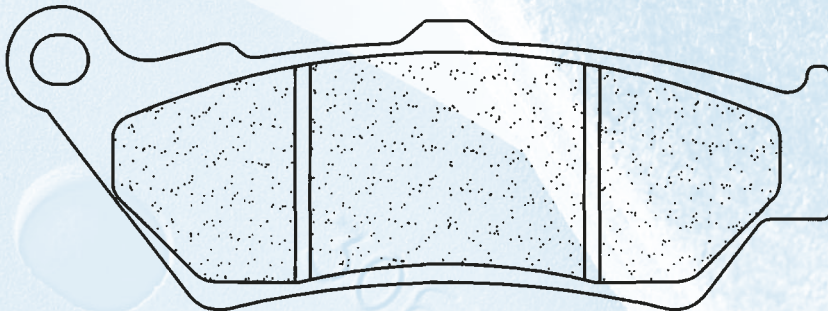

Dim./Size

→ 108,5 mm
↑↓ 40,1 mm
H 7,7 mm

2396

APRILIA

| | | | | |
|----------|---------------------|---------|---|---|
| 650 | Moto 6.5 | 95 - | 1 | ● |
| 650 | Pegaso | 97 - 00 | 1 | ● |
| 650 | Pegaso Le | 01 - | 1 | ● |
| 650 | Pegaso Le TTR | 04 - | 1 | ● |
| 650 | Pegaso Trail | 06 - | 1 | ● |
| ETV 1000 | Caponord | 01 - | 2 | ● |
| ETV 1000 | Caponord Rally Raid | 04 - | 2 | ● |

BMW

| | | | | |
|----------|------------|---------|---|---|
| 125 | C1 | 00 - | 1 | ● |
| 200 | C1 | 02 - | 1 | ● |
| F 650 | CS Scarver | 02 - 06 | 1 | ● |
| F 650 | Funduro | 94 - 00 | 1 | ● |
| F 650 | GS | 08 - | 1 | ● |
| F 650 | GS, Rallye | 01 - 07 | 1 | ● |
| F 650 | GS Dakar | 01 - 07 | 1 | ● |
| F 650 | Strada | 97 - | 1 | ● |
| G 650 | Xchallenge | 07 - | 1 | ● |
| G 650 | Xcountry | 07 - | 1 | ● |
| F 800 | GS | 08 - | 2 | ● |
| HP2 1200 | Enduro | 06 - | 2 | ● |

DUCATI

| | | | | |
|------------------|-----------------|------|---|---|
| SportClassic1000 | Sport / Biposto | 07 - | 2 | ● |
| SportClassic1000 | GT | 05 - | 2 | ● |
| SportClassic1000 | GT Touring | 09 - | 2 | ● |
| 1000 | Paul Smart LE | 06 - | 2 | ● |

HONDA

| | | | | |
|---------|-------------|---------|---|---|
| CB 500 | S | 98 - 03 | 1 | ● |
| CB 500 | | 97 - 03 | 1 | ● |
| NT 650 | V Deauville | 98 - 01 | 2 | ● |
| NX 650 | Dominator | 97 - | 1 | ● |
| SLR 650 | | 97 - | 1 | ● |
| 650 | Vigor | 99 - | 1 | ● |

KTM

| | | | | |
|----------|---------------|---------|---|---|
| LC-8 950 | Adventure | 02 - | 2 | ● |
| 950 | Superenduro | 06 - | 1 | ● |
| 990 | Adventure / S | 06 - 08 | 2 | ● |

MOTO GUZZI

| | | | | |
|---------|--------------------------------------------|---------|---|---|
| 940 | Bellagio / Custom | 07 - | | ● |
| ES 1100 | Quota | 99 - 01 | 2 | ● |
| 1100 | California (2 pin pad fixing) | 01 - 05 | | ● |
| 1100 | California Vintage | 06 - 10 | | ● |
| 1100 | California EV (2 pin pad fixing) | 01 - | | ● |
| 1100 | California Jackal (Single pin pad fixing) | 99 - 01 | | ● |
| 1100 | California Special (Single pin pad fixing) | 99 - 00 | | ● |
| 1100 | California Sport (2 pin pad fixing) | 01 - 02 | | ● |
| 1100 | Metal | 02 - 03 | | ● |
| 1100 | Aluminium | 03 - 05 | | ● |
| 1100 | Titanium Handlebar Fairing | 03 - 05 | | ● |
| 1100 | Classic | 06 - 09 | | ● |
| 1100 | Touring | 06 - 07 | | ● |

2396 suite

| MOTO MORINI | | | |
|--------------|-----------------------|---------|-----|
| 1200 | Granpasso | 08 - 10 | 2 ● |
| 1200 | GT | 10 | 2 ● |
| TRIUMPH | | | |
| 1600 | Thunderbird | 09 - | ● |
| 2300 | Rocket III | 04 - | ● |
| 2300 | Rocket III Classic | 07 - | ● |
| 2300 | Rocket III Roadster | 10 - | ● |
| VICTORY | | | |
| Kingpin 1500 | | 04 - 07 | ● |
| Kingpin 1500 | Tour | 04 - 07 | ● |
| Touring 1500 | Cruiser | 05 - | ● |
| V92 1500 | V92C Cruiser / Deluxe | 98 - 03 | ● |
| V92 1500 | V92SC Sport Cruiser | 00 - 03 | ● |
| Hammer 1634 | | 05 - 07 | ● |

| VICTORY | | | |
|-------------|----------------------|---------|-----|
| Hammer 1634 | S | 07 - 08 | ● |
| Vegas 1634 | | 03 - 07 | ● |
| Vegas 1634 | Arlen Ness / Jackpot | 04 - 07 | ● |
| Vegas 1634 | 8-Ball | 05 - 07 | ● |
| YAMAHA | | | |
| DT 125 | X Supermotard | 05 - 06 | 1 ● |
| XT 660 | R | 04 - | 1 ● |

| Street | Sport | Racing | Enduro | MX | Off Road Racing | ATV |
|--------|-------|--------|--------|------|-----------------|-----|
| S4 | A3+ | XBK5 | C59 | EN10 | MX10 | X59 |

2398

Dim./Size

→ 67,7 mm
↑ 50,7 mm
H 7 mm

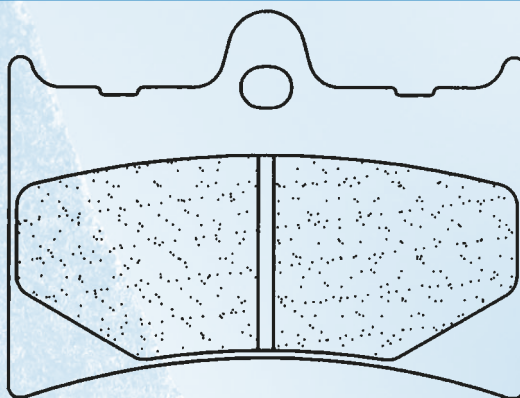

| ALFER | | | |
|----------|---------------------|---------|-----|
| MC 125 | | 88 | 1 ● |
| GR 250 | Enduro | 88 | 1 ● |
| MC 250 | | 88 | 1 ● |
| GR 300 | Enduro | 88 | 1 ● |
| APRILIA | | | |
| AF 1 125 | Europa / Futura | 90 - 91 | 1 ● |
| AF 1 125 | Replica / Sintesi | 89 - 91 | 1 ● |
| RS 125 | / Extrema / Replica | 93 - 98 | 1 ● |
| RS 125 | | 99 - 05 | 1 ● |
| RS 125 | R Piste | 04 - 05 | 1 ● |
| 125 | Sport Prot. | 92 | 1 ● |
| 125 | Tuono | 04 - | 1 ● |
| AF 1 250 | Replica | 90 - | 1 ● |
| ASPES | | | |
| 125 | Sintesi | 88 - | 1 ● |
| ATK | | | |
| ATK 250 | CC / MX | 91 - 92 | 1 ● |
| ATK 350 | ES / CC / MX / STD | 91 - 92 | 1 ● |
| ATK 406 | CC / MX | 91 - 92 | 1 ● |
| ATK 560 | | 89 - 91 | 1 ● |
| ATK 604 | Quadracer | 90 - | 1 ● |
| ATK 604 | ES / CC / MX / STD | 91 - 92 | 1 ● |
| BENELLI | | | |
| 50 | Devil | 92 | 1 ● |
| 50 | Spring | 92 | 1 ● |
| BX 125 | | 89 | 1 ● |
| 125 | Jarno | 89 | 2 ● |
| GILERA | | | |
| 125 | Crono | 92 - | 1 ● |
| 125 | CX | 91 - | 1 ● |

| GILERA | | | |
|------------|-------------|---------|-----|
| 125 | Freestyle | 92 - | 1 ● |
| 125 | MX1 / MXR | 89 - | 1 ● |
| 125 | SP 01 | 90 | 1 ● |
| 125 | SP 02 | 90 - | 1 ● |
| 600 | Nordwest | 91 - | 2 ● |
| KTM | | | |
| MX 250 | Enduro VC | 87 | ● ● |
| EXC 350 | | 87 | ● ● |
| GS 350 | | 87 | ● ● |
| MX 350 | | 87 | ● ● |
| 400 | Enduro | 87 - | ● ● |
| MX 500 | | 87 | ● ● |
| LC4 550 | | 87 - | ● ● |
| MX 550 | | 87 - | ● ● |
| EXC 600 | | 87 | ● ● |
| LC4 600 | Enduro | 88 - | ● ● |
| LC4 600 | | 88 - | ● ● |
| MC 600 | | 88 - | ● ● |
| MX 600 | | 87 | ● ● |
| MX | Enduro / VC | 87 - | ● ● |
| MOTO GUZZI | | | |
| 1000 | Quota | 92 - 97 | 2 ● |

| Street | Sport | Racing | Enduro | MX | Off Road Racing | ATV |
|--------|-------|--------|--------|------|-----------------|-----|
| S4 | A3+ | | EN10 | MX10 | X59 | |

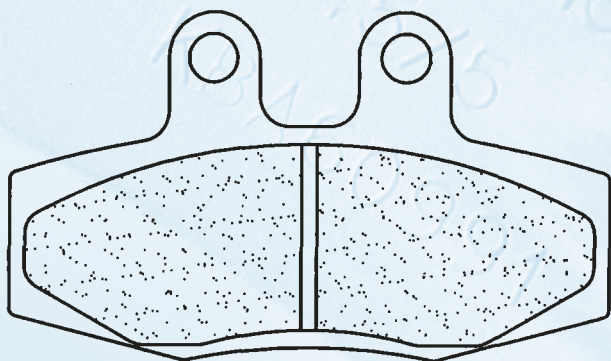

Dim./Size

→ 78,9 mm
↑ 45,9 mm
H 9 mm

2399

| FANTIC | | | |
|---------|--------------------------|------|-----|
| 50 | Extra SM | 98 - | 1 ● |
| 125 | Extra SM | 98 - | 1 ● |
| KTM | | | |
| | GS / EXC / Enduro models | 91 | 1 ● |
| EXC 125 | | 90 | 1 ● |
| GS 125 | | 88 | 1 ● |
| MX 125 | | 88 | 1 ● |
| EXC 250 | | 90 | 1 ● |
| GS 250 | | 88 | 1 ● |
| MX 250 | | 88 | 1 ● |
| EXC 300 | | 90 | 1 ● |
| EXC 350 | | 88 - | 1 ● |
| GS 350 | | 88 - | 1 ● |
| MX 350 | | 88 | 1 ● |
| MX 500 | | 88 | 1 ● |
| EXC 600 | | 88 | 1 ● |
| MX 600 | | 88 | 1 ● |
| MAICO | | | |
| | All Models | 89 | 1 ● |
| | All Models | 91 | 1 ● |
| GP 250 | All Models | 89 | 1 ● |
| 350 | | 93 - | 1 ● |
| GP 400 | All Models | 89 | 1 ● |
| GP 500 | All Models | 89 | 1 ● |
| 500 | | 93 - | 1 ● |

Street Sport Racing Enduro MX Off Road Racing ATV

S4 A3+

EN10 MX10

2400

Dim./Size

→ 99,9 mm
↑↓ 47 mm
H 8,5 mm

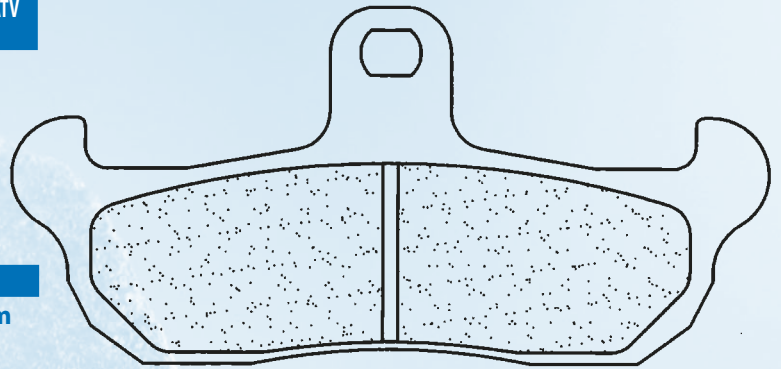

APRILIA

| | | | | | |
|------|-----|--------------|---------|---|---|
| AF 1 | 125 | | 87 - | 1 | ● |
| RX | 125 | | 90 - 96 | 1 | ● |
| | 125 | Tuareg Rally | 90 - 91 | 1 | ● |
| | 350 | Tuareg | 88 - 89 | 1 | ● |
| | 350 | Tuareg Wind | 90 - | 1 | ● |
| | 600 | Pegaso | 90 - | 1 | ● |
| | 600 | Tuareg | 88 - | 1 | ● |
| | 600 | Tuareg Wind | 90 - | 1 | ● |

CAGIVA

| | | | | | |
|-----|-----|---------------|---------|---|---|
| WMX | 50 | | 89 - | 1 | ● |
| | 50 | Supercity | 93 - | 1 | ● |
| | 80 | Super City | 94 - | 1 | ● |
| | 125 | Supercity | 92 - 95 | 1 | ● |
| K7 | 125 | | 91 - | 1 | ● |
| W8 | 125 | / R | 94 - | 1 | ● |
| WMX | 125 | | 89 - 90 | 1 | ● |
| WMX | 125 | | 88 | 1 | ● |
| | 125 | Cruiser | 87 | 1 | ● |
| | 125 | Freccia | 89 | 1 | ● |
| | 125 | Freccia C12 R | 91 - | 1 | ● |
| | 125 | Mito Racer | 91 - 92 | 1 | ● |
| | 125 | N1 | 97 - | 1 | ● |
| | 125 | N90 | 91 - | 1 | ● |
| | 125 | Supercity | 98 - | 1 | ● |
| | 125 | Tamanaco | 88 - 89 | 1 | ● |
| | 125 | Cross | 86 - | 1 | ● |
| WMX | 250 | | 89 - 90 | 1 | ● |
| WMX | 250 | | 88 - | 1 | ● |
| | 250 | Cross | 86 - | 1 | ● |
| | 350 | W 12 | 92 - | 1 | ● |
| | 600 | W16 | 95 - | 1 | ● |

GILERA

| | | | | | |
|----|-----|-----------|------|---|---|
| RC | 125 | Top Rally | 90 - | 1 | ● |
| | 125 | Apache | 91 - | 1 | ● |
| RC | 600 | Top Rally | 90 - | 1 | ● |

HUSABERG

| | | | | | |
|--|-----|------------|---------|---|---|
| | 350 | | 91 - | 1 | ● |
| | 500 | Enduro | | 1 | ● |
| | | All models | 89 - 92 | 1 | ● |

HUSQVARNA

| | | | | | |
|-----|-----|---------------------------|---------|---|---|
| CR | 125 | | 91 - 95 | 1 | ● |
| WR | 125 | | 91 - 96 | 1 | ● |
| WR | 125 | | 85 - 90 | 1 | ● |
| WRK | 125 | | 90 | 1 | ● |
| WR | 240 | | 91 - | 1 | ● |
| WR | 240 | | 87 - 90 | 1 | ● |
| WRK | 240 | | 90 | 1 | ● |
| CR | 250 | | 91 - 96 | 1 | ● |
| WR | 250 | | 87 - 90 | 1 | ● |
| WR | 250 | | 90 - 96 | 1 | ● |
| XC | 250 | | 87 - 90 | 1 | ● |
| WR | 260 | | 90 - | 1 | ● |
| TE | 350 | Enduro | 90 | 1 | ● |
| WR | 360 | | 96 | 1 | ● |
| WR | 400 | | 87 - | 1 | ● |
| TE | 410 | | 96 | 1 | ● |
| CR | 430 | | 87 - | 1 | ● |
| WR | 430 | | 87 - | 1 | ● |
| XC | 430 | | 87 - | 1 | ● |
| | 430 | Auto | 87 - | 1 | ● |
| XC | 500 | | 87 - | 1 | ● |
| TE | 510 | | 87 - 89 | 1 | ● |
| TE | 510 | | 90 - | 1 | ● |
| TC | 610 | Cross | 91 - 96 | 1 | ● |
| TE | 610 | | 91 - 96 | 1 | ● |
| | | All Models TE/TC/WR/CR/AE | 89 | 1 | ● |

KRAM IT

| | | | | | |
|----|-----|--|---------|---|---|
| ER | 125 | | 89 - 93 | 1 | ● |
| MC | 250 | | 89 | 1 | ● |
| ER | 300 | | 89 | 1 | ● |

MOTO MORINI

| | | | | | |
|-----|-----|---------------------|------|---|---|
| RLX | 350 | Excalibur | 90 - | 1 | ● |
| | 350 | Coguardo / New York | 90 - | 1 | ● |
| | 350 | Dart | 88 | 1 | ● |
| | 400 | Dart | 89 | 1 | ● |
| RLX | 501 | Excalibur | 90 - | 1 | ● |
| | 501 | Coguardo | 89 | 1 | ● |

YAMAHA

| | | | | | |
|------|-----|---------------------------|---------|---|---|
| DT-Z | 125 | Ténére / Scout | 89 - 90 | 1 | ● |
| TDR | 125 | (3HS1/3XD03SH3/3XD1) | 89 - 93 | 1 | ● |
| TDR | 125 | R (3SH2/3XE2) Lightburner | 93 - 94 | 1 | ● |



Street Sport Racing Enduro MX Off Road Racing ATV

XBK5 C59

2404

Dim./Size

→ 91,7 mm
↑↓ 51,6 mm
H 10 mm

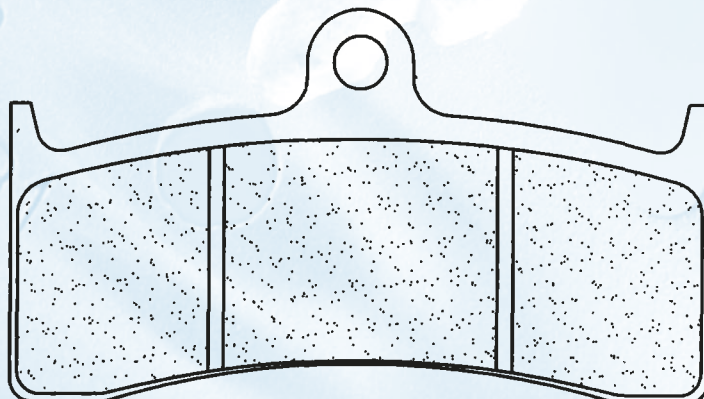

BERINGER

| | | | |
|--|--------------------------------|---|---|
| | 6 Piston Caliper - Road/Racing | 1 | ● |
|--|--------------------------------|---|---|

NISSIN

| | | | |
|--|--------------------------------|---|---|
| | 6 Piston Caliper - Road/Racing | 1 | ● |
|--|--------------------------------|---|---|

Street Sport Racing Enduro MX Off Road Racing ATV

S4 A3+ MX10 ATV1

DAELIM

| | | | | |
|--------|--------|------|---|---|
| 100 | Altino | 98 - | 1 | ● |
| NF 125 | | 03 - | 1 | ● |
| VS 125 | | 98 - | 1 | ● |
| 125 | Altino | 02 - | 1 | ● |

HONDA

| | | | | |
|---------|------------|---------|---|---|
| CB 50 | All Models | 80 - 81 | 1 | ● |
| CRM 50 | | 88 - 92 | 1 | ● |
| CRM 50 | | 93 - 96 | 1 | ● |
| MB 50 | S | 80 - 82 | 1 | ● |
| MBX 50 | | 80 - 82 | 1 | ● |
| MRX 50 | | 88 - | 1 | ● |
| CB 80 | | 80 - 81 | 1 | ● |
| MBX 80 | FWD | 83 - 86 | 2 | ● |
| CB 125 | RS | 83 - | 1 | ● |
| CG 125 | | 04 - | 1 | ● |
| CG 150 | | 04 - | 1 | ● |
| ATC 250 | R | 81 | 1 | ● |

HYOSUNG

| | | | | |
|--------|--------|------|---|---|
| TE 450 | Rapier | 06 - | 2 | ● |
|--------|--------|------|---|---|

KAWASAKI

| | | | | |
|---------|-----------------------|---------|---|---|
| BN 125 | Eliminator A1 / A2 | 98 - 99 | 1 | ● |
| KVF 300 | A1-A2 / B1-B2 Prairie | 99 - | 2 | ● |
| KVF 360 | 2x4 / 4x4 Prairie | 03 - 06 | 2 | ● |
| KFX 400 | | 02 - | 2 | ● |
| KVF 400 | A1-A2 / B1 Prairie | 97 - 98 | 2 | ● |
| KVF 400 | C1-C2 / D1-D2 Prairie | 99 - | 2 | ● |

SUZUKI

| | | | | |
|----------|-----------------------------|---------|---|---|
| DF 125 | | 98 - 00 | 1 | ● |
| DR 125 | | 86 - 02 | 1 | ● |
| GX 125 | R | 88 - | 1 | ● |
| RH 125 | X | 87 | 1 | ● |
| SP 125 | G / H / J | 86 - 88 | 1 | ● |
| SX 125 | R | 85 - | 1 | ● |
| TS 125 | X | 86 - 90 | 1 | ● |
| DF 200 | (SH42A) | 98 - 00 | 1 | ● |
| DR 200 | G / H / J | 86 - 89 | 1 | ● |
| DR 200 | SE / T | 93 - 08 | 1 | ● |
| SP 200 | G / H / J | 86 - 88 | 1 | ● |
| SX 200 | R | 85 - | 1 | ● |
| RH 240 | X | 87 - | 1 | ● |
| TS 240 | X | 85 - | 1 | ● |
| DR 250 | F | 85 | 1 | ● |
| DR 250 | S | 86 - 89 | 1 | ● |
| LT-F 250 | Ozark | 02 - 10 | 2 | ● |
| LT-Z 250 | Quad Sport | 04 - 10 | 2 | ● |
| RH 250 | | 85 - | 1 | ● |
| SP 250 | F | 85 | 1 | ● |
| TS 250 | X | 85 - 89 | 1 | ● |
| LT-A 400 | Eiger 2WD / 4WD | 02 - 07 | 2 | ● |
| LT-F 400 | Eiger 2WD / 4WD | 02 - 07 | 2 | ● |
| LT-Z 400 | Quad Sport | 03 - 10 | 2 | ● |
| LT-A 500 | FK2 - FK7 Vinson | 02 - 07 | 2 | ● |
| LT-F 500 | FK3 - FK7 Vinson Quadrunner | 03 - 07 | 2 | ● |
| LT-A 650 | FK2 Vinson | 02 - | 2 | ● |

SYM

| | | | | |
|-----|------------|---------|---|---|
| 600 | Quadraider | 06 - 07 | 2 | ● |
|-----|------------|---------|---|---|

2408

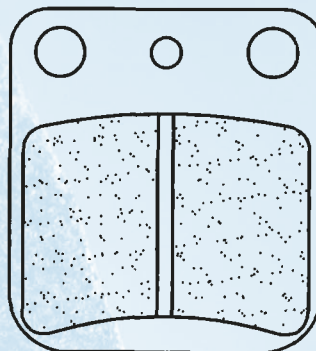

Dim./Size
← 41,2 mm
↑ 45,2 mm
H 8 mm

YAMAHA

| | | | | |
|---------|-------------------------|---------|---|---|
| SX 125 | R | 88 - | 1 | ● |
| YFS 200 | R Blaster | 03 - 06 | 2 | ● |
| YFM 250 | AN Bruin | 05 - 06 | 2 | ● |
| YFM 250 | Bear Tracker | 01 - 04 | 2 | ● |
| YFM 250 | Big Bear | 07 - | 2 | ● |
| YFM 300 | Warrior | 89 | 2 | ● |
| YFM 350 | Big Bear | 99 | 2 | ● |
| YFM 350 | Bruin 4x2 / 4x4 | 04 - 06 | 2 | ● |
| YFM 350 | Wolverine 4x2 | 95 - 05 | 2 | ● |
| YFM 350 | Wolverine 4x2 | 06 - 09 | 2 | ● |
| YFM 350 | Grizzly 4x2 / 4x4 | 07 - | 2 | ● |
| YFM 350 | Warrior XW/XA-M | 89 - | 2 | ● |
| YFM 350 | XA - M Warrior | 92 - 04 | 2 | ● |
| YFZ 350 | Banshee (T-W) | 90 - 09 | 2 | ● |
| YFM 400 | FAM / FAN kodiak | 00 - 01 | 2 | ● |
| YFM 400 | FPR/FPS Big Bear | 03 - 04 | 2 | ● |
| YFM 400 | Kodiak Auto FAR/FAS | 03 - 04 | 2 | ● |
| YFM 400 | Kodiak AR (5VH3/4) | 03 | 2 | ● |
| YFM 400 | FAT/FAV (Big Bear) | 05 - 06 | 2 | ● |
| YFM 400 | Grizzly FGW/FGX | 07 - 08 | 2 | ● |
| YFM 450 | Kodiak FAR/FAS (5ND3/4) | 03 - 04 | 2 | ● |
| YFM 450 | Kodiak FAT/FAHT/FAV | 05 - 06 | 2 | ● |
| YFM 450 | Wolverine FXV-FXZ | 06 - | 2 | ● |
| YFM 660 | Raptor RN-RT | 01 - 05 | 2 | ● |
| YFM 660 | Grizzly FR / FS/FT | 03 - 05 | 2 | ● |
| YFM 660 | Grizzly FWAP-FWAV | 02 - 08 | 2 | ● |

Street Sport Racing Enduro MX Off Road Racing ATV

S4 MX10

YAMAHA

| | | | | |
|----------|---------------------|---------|---|---|
| DT 50 | LC | 98 - | 1 | ● |
| YZ 80 | S / T / U / W | 86 - 89 | 1 | ● |
| YZ 80 | A / B / D | 90 - 92 | 1 | ● |
| YZ 80 | E / F / G / H1 / J1 | 93 - 01 | 1 | ● |
| YZ 85 | All models | 02 - 10 | 1 | ● |
| TT-R 125 | LW | 00 - 10 | 1 | ● |

Dim./Size
← 82,8 mm
↑ 22 mm
H 7,2 mm

2424

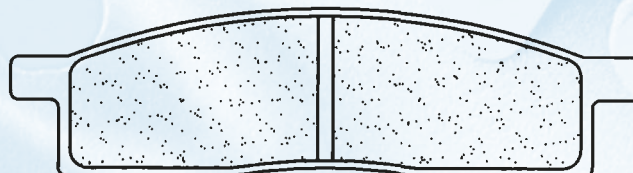

Street Sport Racing Enduro MX Off Road Racing ATV

S4 A3+ XBK5

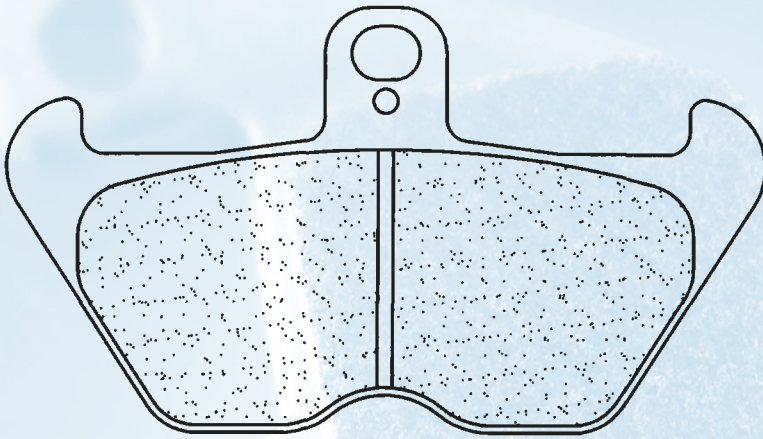

2430

Dim./Size
→ 99,8 mm
↑ 55,8 mm
H 8,5 mm

BMW

| | | | | | |
|------|------|-------------------|---------|---|---|
| R80 | 800 | R Roadster | 91 - | 1 | ● |
| R | 850 | C | 98 - | 2 | ● |
| R | 850 | GS | 98 - | 2 | ● |
| R | 850 | R | 95 - 02 | 2 | ● |
| R | 850 | RT | 98 - 00 | 2 | ● |
| K1 | 1000 | | 89 - 93 | 2 | ● |
| K100 | 1000 | LT | 92 - | 2 | ● |
| R100 | 1000 | R | 91 - 95 | 1 | ● |
| R100 | 1000 | Roadster / Mystic | 93 - 95 | 1 | ● |
| R100 | 1000 | RS (4V) | 90 - 92 | 2 | ● |
| K | 1100 | All models | 92 - | 2 | ● |
| K | 1100 | LT / LTS | 92 - | 2 | ● |
| K | 1100 | RS / RT | 93 - | 2 | ● |
| K | 1100 | RS ABS | 93 - | 2 | ● |
| R | 1100 | GS | 95 - 99 | 2 | ● |
| R | 1100 | GS | 00 - 01 | 2 | ● |
| R | 1100 | GS ABS | 95 - 01 | 2 | ● |
| R | 1100 | R | 95 - | 2 | ● |
| R | 1100 | RS | 93 | 2 | ● |
| R | 1100 | RS | 94 - | 2 | ● |
| R | 1100 | RS ABS | 93 - | 2 | ● |
| R | 1100 | RT | 95 - | 2 | ● |
| R | 1100 | RT ABS | 95 - | 2 | ● |
| R | 1100 | S | 99 - 00 | 2 | ● |
| R | 1150 | GS | 00 - 01 | 2 | ● |
| K | 1200 | LT | 99 - 00 | 2 | ● |
| K | 1200 | RS | 99 - 01 | 2 | ● |
| R | 1200 | C | 98 - | 2 | ● |

Street Sport Racing Enduro MX Off Road Racing ATV

S4 A3+ RX3 MX10

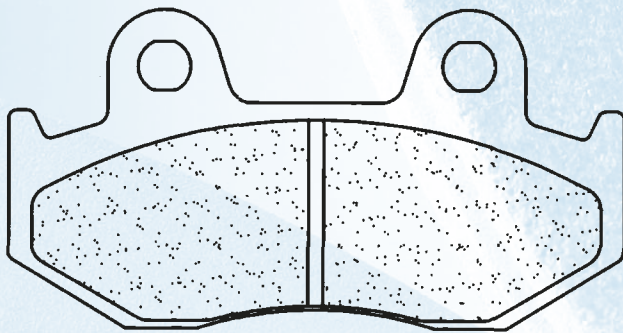

2451

Dim./Size
→ 81,1 mm
↑ 42 mm
H 7,3 mm

HONDA

| | | | | | |
|-----|-----|--------------|---------|---|---|
| MBX | 80 | | 86 - | 1 | ● |
| MTX | 80 | R | 87 - | 1 | ● |
| CR | 125 | RG | 86 | 1 | ● |
| CR | 125 | RE / RF | 84 - 85 | 1 | ● |
| MTX | 125 | R | 84 - 95 | 1 | ● |
| NSR | 125 | F | 88 - 89 | 1 | ● |
| XL | 125 | R | 86 | 1 | ● |
| MTX | 200 | R | 85 - | 1 | ● |
| CB | 250 | RS | 85 - | 1 | ● |
| CR | 250 | RE / RF | 84 - 85 | 1 | ● |
| CR | 250 | RG | 86 | 1 | ● |
| FTR | 250 | | 86 - | 1 | ● |
| XL | 250 | R | 84 - 87 | 1 | ● |
| XLR | 250 | R | 88 - | 1 | ● |
| XR | 250 | R | 84 - 87 | 1 | ● |
| XL | 350 | R | 84 - 85 | 1 | ● |
| XR | 350 | R | 84 - 85 | 1 | ● |
| CR | 500 | RE / RF / RG | 84 - 86 | 1 | ● |
| XLR | 500 | R | 83 - | 1 | ● |
| XR | 500 | R Pro Link | 83 - 84 | 1 | ● |
| XR | 500 | R | 86 - | 1 | ● |
| XL | 600 | R | 83 - 87 | 1 | ● |
| XLM | 600 | LM | 87 - | 1 | ● |
| XR | 600 | R | 83 - 87 | 1 | ● |

Street Sport Racing Enduro MX Off Road Racing ATV

A3+ MX10 ATV1

2466

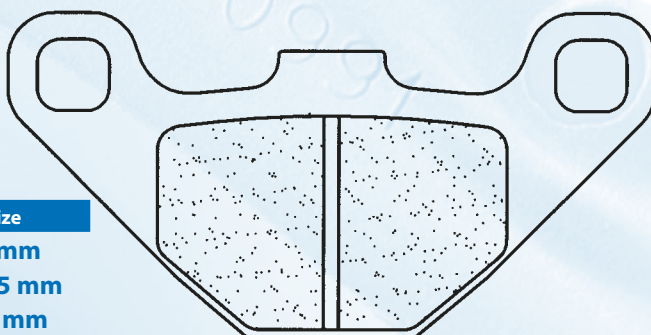

Dim./Size
→ 85 mm
↑ 42,5 mm
H 6,5 mm

ADLY

| | | | |
|-----|-------------|------|---|
| 150 | Interceptor | 05 - | ● |
| 300 | Interceptor | 05 - | ● |

HERCULES

| | | | | |
|----|-------|------|---|---|
| GP | Supra | 80 - | 1 | ● |
|----|-------|------|---|---|

MALAGUTI

| | | | | | |
|-----|-----|-------|------|---|---|
| MEX | 50 | | 86 - | 1 | ● |
| MFX | 50 | | 86 - | 1 | ● |
| MGX | 425 | Ronco | 87 - | 1 | ● |

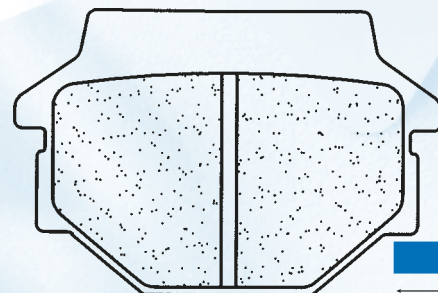

Dim./Size
→ 56 mm
↑ 37,1 mm
H 8,7 mm

Street Sport Racing Enduro MX Off Road Racing ATV
S4 MX10 X59 ATV1

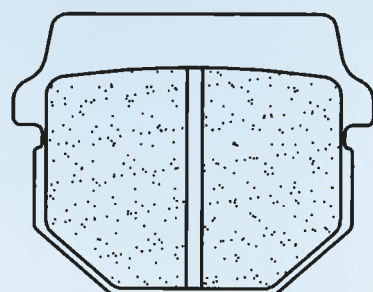
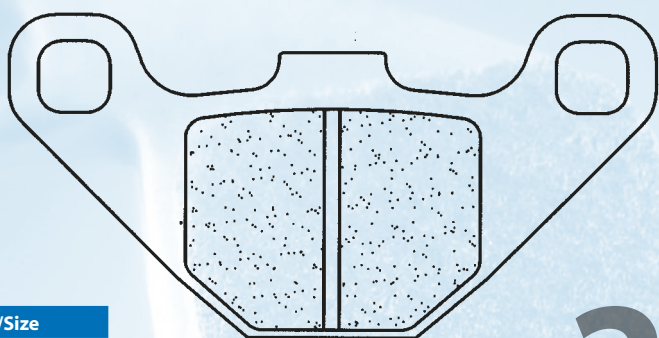

Dim./Size
← 47,4 mm
↑↓ 37,1 mm
H 8,7 mm

Dim./Size
← 85 mm
↑↓ 42,5 mm
H 6,5 mm

2469

| | | | | | |
|-------------------|----------------------------|---------|---|---|---|
| ADLY | | | | | |
| 150 | Interceptor | 05 - | 2 | ● | |
| 150 | ATV | 05 - | 2 | ● | ● |
| 300 | Interceptor | 05 - | 2 | ● | |
| 300 | ATV | 05 - | 2 | ● | ● |
| AEON | | | | | |
| 100 | Revo 2 | 04 - | | | ● |
| APRILIA | | | | | |
| RX 125 | Enduro | 08 | | | ● |
| RX 125 | Supermotard | 08 - | | | ● |
| SX 125 | | 08 - | | | ● |
| BOMBARDIER | | | | | |
| 200 | Rally 2x4 | 03 - 04 | 2 | ● | |
| 200 | Rally 2x4 | 05 - | 2 | ● | |
| CAN-AM | | | | | |
| 90 | DS X | 08 - | 2 | ● | ● |
| CPI | | | | | |
| XS 250 | Quad | 06 - | 2 | ● | |
| DAELIM | | | | | |
| 250 | Sector Quad | 05 - 06 | 2 | ● | |
| DERBI | | | | | |
| DXR 200 | Quad (front disc) | 04 - | 2 | ● | |
| DXR 250 | Quad (front disc) | 04 - | 2 | ● | |
| E-TON | | | | | |
| VXL 250 | Vector, ST Vector | 06 - | 2 | ● | |
| VTX 300 | Vortex, ST Vortex | 07 - | 2 | ● | |
| VXL 300 | Vector, ST Vector | 07 - | 2 | ● | |
| FACTORY | | | | | |
| 50 | Helix | 04 - | | | ● |
| 50 | Rex | 04 - | | | ● |
| 100 | Helix | 04 - | | | ● |
| 100 | Rex | 04 - | | | ● |
| FANTIC | | | | | |
| 125 | Caballero Motard Aircooled | 10 - | | | ● |
| 125 | Regolarna Casa | 08 - | | | ● |
| 125 | Supersei Motard | 08 - | | | ● |
| HONDA | | | | | |
| MB 80 | | 80 - | 1 | ● | |
| MCX 80 | | 82 - | 1 | ● | |
| KAWASAKI | | | | | |
| AR 50 | | 81 - 82 | 1 | ● | |
| KMX 50 | | 88 - | 1 | ● | |
| KSR 50 | I | 90 - | 1 | ● | ● |
| AR 80 | | 81 - | 1 | ● | |
| KD 80 | N1 / N3 | 88 - 90 | 1 | ● | |
| KMX 80 | | 87 - | 1 | ● | |
| KSR 80 | II | 90 - | 1 | ● | ● |

| | | | | | |
|-----------------|-----------------------|---------|---|---|---|
| KAWASAKI | | | | | |
| KX 80 | E / G / H / J | 84 - 87 | 1 | ● | |
| KX 80 | L / N / R - R6 | 88 - 96 | 1 | ● | |
| KX 100 | | 88 - 92 | 1 | ● | |
| KX 100 | B5 / B6 | 95 - 96 | 1 | ● | |
| KDX 125 | A / B | 90 - | 1 | ● | |
| KMX 125 | | 86 | 1 | ● | |
| KMX 125 | | 87 - 02 | 1 | ● | |
| KMX 125 | | 86 | 1 | ● | |
| KMX 125 | | 87 - 02 | 1 | ● | |
| KX 125 | B1 | 82 | 1 | ● | |
| ZL 125 | Eliminator | 97 - | 1 | ● | |
| KMX 200 | A2 / A3 / A4 | 88 - 92 | 1 | ● | |
| KX 250 | B1 | 82 | 1 | ● | |
| KXT 250 | A1 Tecate Trike | 84 - | | | ● |
| MAICO | | | | | |
| C-1 50 | Hard Enduro | 99 - | 1 | ● | |
| X-1 50 | SuperCross | 99 - | 1 | ● | |
| MONTESA | | | | | |
| 80 | Junior | 96 - | 1 | ● | |
| MZ / MUZ | | | | | |
| 150 | VRS | | | | ● |
| PGO | | | | | |
| 50 | X-Rider | 03 - | | | ● |
| 125 | X-Rider | 03 - | | | ● |
| 150 | X-Rider | 03 - | | | ● |
| POLARIS | | | | | |
| 200 | Phoenix | 05 - 08 | 2 | ● | |
| 200 | Sawtooth | 06 | 2 | ● | ● |
| SUZUKI | | | | | |
| CP 50 | | 85 - | 1 | ● | |
| CR 50 | DC | 87 - | 1 | ● | |
| RM 80 | G / H / J / K | 86 - 89 | 1 | ● | |
| RM 80 | L / M / N / P / R / S | 90 - 95 | 1 | ● | ● |
| RM 80 | T | 96 - 01 | | | ● |
| RM 85 | / L | 02 - 04 | | | ● |
| TGB | | | | | |
| 50 | Hornet | 04 - 05 | | | ● |
| 90 | Hornet | 04 - 05 | | | ● |
| 250 | Blade / Congo | 06 - 07 | | | ● |
| 325 | Target 4x2 | 09 - | 2 | ● | |
| 325 | Blade 4x2 / LE | 07 - | | | ● |
| 400 | Target 4x2 | 09 - | 2 | ● | |
| 425 | Target 4x2 | 09 - | 2 | ● | |
| 500 | Target 4x2 | 09 - | 2 | ● | |
| 525 | Target 4x4 | 09 - | 2 | ● | |

Buyers Guide/Moto

Street Sport Racing Enduro MX Off Road Racing ATV

RX3

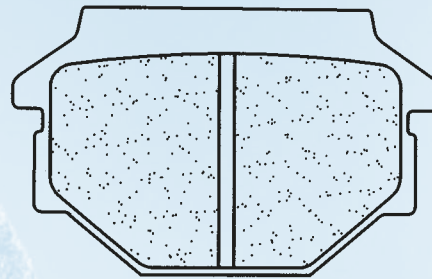
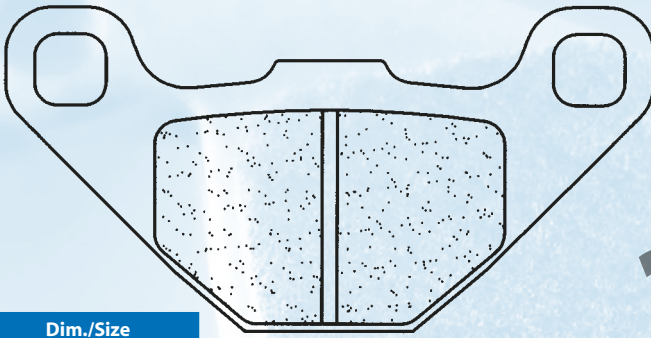

Dim./Size

56 mm
34,9 mm
8,7 mm

Dim./Size

85 mm
42,5 mm
6,5 mm

2472

APRILIA

| | | | |
|--------|--------------|---------|---|
| 125 | Pegaso | 92 - | ● |
| 125 | Tuareg Rally | 92 | ● |
| MX 125 | | 04 - | ● |
| MX 125 | SM | 07 - | ● |
| 600 | Pegaso | 90 - | ● |
| 650 | Pegaso | 92 - 96 | ● |

BUELL

| | | | |
|---------|----------------|---------|---|
| M2 1200 | Cyclone | 98 - 02 | ● |
| S1 1200 | Lightning | 98 - 02 | ● |
| S1 1200 | Whitelightning | 98 - 02 | ● |
| S3 1200 | Thunderbolt | 98 - 02 | ● |

CAGIVA

| | | | |
|--------|--|------|---|
| WMX 50 | | 89 - | ● |
|--------|--|------|---|

MZ / MUZ

| | | | |
|-----|----------------------|---------|---|
| 660 | Baghira (All Models) | 96 - 05 | ● |
| 660 | Black Panther | 00 - | ● |
| 660 | Mastiff 21" | 96 - 05 | ● |
| 660 | Street Moto | 00 - | ● |
| 660 | Super Moto | 07 - | ● |

SACHS

| | | | |
|---------|---------------|---------|---|
| 125 | X-Road | 06 | ● |
| XTC 125 | Supersport | 00 - 07 | ● |
| ZX 125 | | 98 - | ● |
| ZZ 125 | Funbike | 98 - | ● |
| 650 | Roadster V1.6 | 01 - 04 | ● |
| 800 | Roadster V2 | 00 - | ● |
| 805 | B / S | 03 - 04 | ● |

SIMSON

| | | | |
|-----|----|------|---|
| 125 | SR | 01 - | ● |
|-----|----|------|---|

Street Sport Racing Enduro MX Off Road Racing ATV

S4 A3+ XBK5 C59

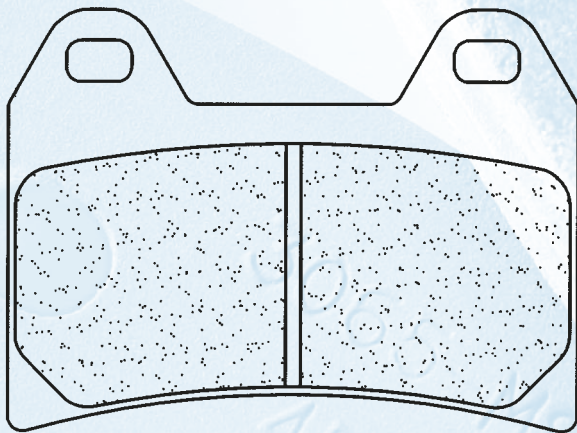

Dim./Size

75 mm
55,5 mm
8,5 mm

2539

BIMOTA

| | | | | |
|-----------|---|------|---|---|
| DB4 900 | | 99 - | 2 | ● |
| SB8 1000 | R | 98 - | 2 | ● |
| SB8K 1000 | | 06 - | 2 | ● |

BMW

| | | | | |
|-------|-------|------|---|---|
| G 650 | Xmoto | 07 - | 1 | ● |
| F 800 | R | 09 - | 2 | ● |
| F 800 | S | 06 - | 2 | ● |
| F 800 | ST | 06 - | 2 | ● |

BREMBO

| | | | | |
|--|-----------------------------------|--|---|---|
| | P4 30x30 Double pin - Road/Racing | | 1 | ● |
|--|-----------------------------------|--|---|---|

CAGIVA

| | | | | |
|------|-------------|------|---|---|
| 650 | Raptor | 01 - | 2 | ● |
| 650 | V-Raptor | 01 - | 2 | ● |
| 1000 | Raptor | 00 - | 2 | ● |
| 1000 | V-Raptor | 00 - | 2 | ● |
| 1000 | Xtra Raptor | 02 - | 2 | ● |

DUCATI

| | | | | |
|--------|-----------------------|---------|---|---|
| 400 | Monster (Japan) | 02 - | 1 | ● |
| 600 | Monster | 00 - 01 | 1 | ● |
| 620 | Monster Dark i.e | 02 - 05 | 2 | ● |
| 620 | Monster i.e | 02 - 05 | 2 | ● |
| 620 | Monster si.e | 02 - 05 | 2 | ● |
| 620 | Multistrada Dark | 05 - | 1 | ● |
| 620 | Sport | 03 - | 2 | ● |
| M 696 | Monster | 08 - | 2 | ● |
| 748 | / S | 99 - 03 | 2 | ● |
| 748 | R | 00 | 2 | ● |
| 748 | SPS | 98 - 99 | 2 | ● |
| 750 | Monster / Monster i.e | 00 - 02 | 2 | ● |
| 750 | Sport / Supersport | 00 - 02 | 2 | ● |
| 796 | Hypermotard | 10 - | 2 | ● |
| 796 | Monster | 10 - | 2 | ● |
| 800 | Monster i.e / si.e | 03 - 05 | 2 | ● |
| 800 | Sport / Supersport | 03 | 2 | ● |
| 800 | Supersport | 04 | 2 | ● |
| 848 | | 08 - | 2 | ● |
| 900 | Monster / Monster i.e | 00 - 02 | 2 | ● |
| MH 900 | e | 01 - | 2 | ● |
| 900 | Supersport | 98 - 02 | 2 | ● |
| 916 | Monster S4 | 01 - 03 | 2 | ● |
| 916 | SPS | 97 - 98 | 2 | ● |

APRILIA

| | | | | |
|----------|-------------------|---------|---|---|
| RS 250 | | 97 - 02 | 2 | ● |
| RS 250 | R Piste | 04 - | 2 | ● |
| 650 | Pegaso Strada | 05 - | 1 | ● |
| SMV 750 | Dorsoduro Factory | 10 - | 2 | ● |
| RST 1000 | Futura | 01 - | 2 | ● |
| RSV 1000 | | 97 - 01 | 2 | ● |
| RSV 1000 | R | 00 | 2 | ● |
| RSV 1000 | SP | 00 - | 2 | ● |
| RSV 1000 | Tuono R | 03 | 2 | ● |
| RSV 1000 | Tuono R Factory | 04 - | 2 | ● |
| SL 1000 | Falco | 00 - | 2 | ● |

BENELLI

| | | | | |
|------------|--------------|---------|---|---|
| 666 125 | Born in hell | 98 - | 1 | ● |
| 2ue 756 | Cue | 10 - | 2 | ● |
| TnT 899 | / Sport | 07 - | 2 | ● |
| Tre-K 899 | | 07 - | 2 | ● |
| 900 | Tornado 3 | 00 - 02 | 2 | ● |
| TNT 1100 | | 04 | 2 | ● |
| TNT 1130 | | 05 - | 2 | ● |
| Tre-K 1130 | | 06 - | 2 | ● |
| Tre-K 1130 | Amazonas | 07 - | 2 | ● |

2539 suite

| Street | Sport | Racing | Enduro | MX | Off Road Racing | ATV |
|--------|-------|--------|--------|----|-----------------|-----|
|--------|-------|--------|--------|----|-----------------|-----|

S4 A3+ XBK5 C59

| DUCATI | | | | | | |
|------------|-------------------------------------|--|---------|---|---|--|
| 916 | ST4 | | 99 - 01 | 2 | ● | |
| 944 | ST2 | | 97 - 03 | 2 | ● | |
| 992 | ST3 | | 04 - | 2 | ● | |
| 992 | ST3s ABS | | 06 - | 2 | ● | |
| 996 | Monster S4R | | 04 - 05 | 2 | ● | |
| 996 | SPS | | 99 - 01 | 2 | ● | |
| 996 | ST4s | | 02 - | 2 | ● | |
| 996 | ST4s ABS | | 03 - | 2 | ● | |
| 998 | / S | | 02 - 03 | 2 | ● | |
| 1000 | Monster Dark i.e / si.e | | 03 - 05 | 2 | ● | |
| 1000 | Monster i.e / si.e | | 03 - 05 | 2 | ● | |
| 1000 | Monster S2R | | 06 - 08 | 2 | ● | |
| 1000 | Monster S4R | | 06 - | 2 | ● | |
| 1000 | Multistrada DS | | 03 - 05 | 2 | ● | |
| 1000 | Multistrada S DS | | 05 - 06 | 2 | ● | |
| 1000 | Supersport DS | | 03 - | 2 | ● | |
| 1100 | Hypermotard | | 07 - | 2 | ● | |
| 1100 | Monster / Monster S | | 09 - | 2 | ● | |
| 1100 | Multistrada | | 07 - | 2 | ● | |
| 1100 | Multistrada S | | 07 - | 2 | ● | |
| 1200 | Multistrada / S | | 10 - | 2 | ● | |
| HUSQVARNA | | | | | | |
| SM | 570 Nox | | 01 - 03 | 1 | ● | |
| LT | 610 E | | 99 - | 1 | ● | |
| SM | 610 SM / SMS | | 98 - | 1 | ● | |
| KTM | | | | | | |
| 625 | SMC | | 05 - 06 | 1 | ● | |
| SMC | 640 LC4 | | 05 | 1 | ● | |
| 640 | Duke II | | 99 - 07 | 1 | ● | |
| 660 | SMC | | 05 - 06 | 1 | ● | |
| 690 | SM | | 07 - 09 | 1 | ● | |
| MOTO GUZZI | | | | | | |
| V7 | 744 Classic | | 08 - | 1 | ● | |
| V7 | 744 Café Classic | | 09 - | 1 | ● | |
| V7 | 750 Clubman Racer | | 10 - | 2 | ● | |
| 750 | Breva i.e | | 03 - | 2 | ● | |
| 750 | Nevada / Nevada Club | | 03 - 04 | 1 | ● | |
| 750 | Nevada Classic i.e | | 05 - | 1 | ● | |
| 750 | Nevada Touring | | 07 - | 1 | ● | |
| 850 | Breva | | 07 - | 2 | ● | |
| 850 | Griso | | 07 - | 2 | ● | |
| 850 | Norge | | 07 - | 2 | ● | |
| 940 | Bellagio / Custom | | 07 - | 2 | ● | |
| V11 | 1100 Lemans (All Models) | | 01 - 04 | 2 | ● | |
| V11 | 1100 Scura / Sport Scura | | 02 - | 2 | ● | |
| V11 | 1100 Sport (All Models) | | 01 - | 2 | ● | |
| 1100 | Breva V1100 | | 05 | 2 | ● | |
| 1100 | Breva | | 05 - 06 | 2 | ● | |
| 1100 | Breva (ABS) | | 07 | 2 | ● | |
| 1100 | California (2 pin pad fixing) | | 01 - 05 | 2 | ● | |
| 1100 | California Vintage | | 06 - 10 | 2 | ● | |
| 1100 | California EV (2 pin pad fixing) | | 01 - | 2 | ● | |
| 1100 | California Sport (2 pin pad fixing) | | 01 - 02 | 2 | ● | |
| 1100 | Metal | | 02 - 03 | 2 | ● | |
| 1100 | Aluminium | | 03 - 05 | 2 | ● | |
| 1100 | Titanium Handlebar Fairing | | 03 - 05 | 2 | ● | |
| 1100 | Classic | | 06 - 09 | 2 | ● | |
| 1100 | Touring | | 06 - 07 | 2 | ● | |
| 1100 | Griso | | 05 - | 2 | ● | |

MOTO GUZZI

| | | | | | | |
|------|-------------------|--|---------|---|---|--|
| 1100 | Griso 8v | | 07 - 08 | 2 | ● | |
| 1200 | Breva | | 08 - | 2 | ● | |
| 1200 | Griso 8V | | 07 - | 2 | ● | |
| 1200 | Norge | | 06 - | 2 | ● | |
| 1200 | Norge GT 8V | | 10 - | 2 | ● | |
| 1200 | Sport ABS | | 06 - 07 | 2 | ● | |
| 1200 | Sport 2V | | 06 - 09 | 2 | ● | |
| 1200 | Sport 4V | | 08 - 09 | 2 | ● | |
| 1200 | Stelvio (ABS) | | 08 - | 2 | ● | |
| 1200 | Stelvio NTX (ABS) | | 09 - | 2 | ● | |

MOTO MORINI

| | | | | | | |
|------|----------------|--|---------|---|---|--|
| 998 | 9 1/2 | | 06 - 10 | 2 | ● | |
| 1187 | MM3 | | 07 | 2 | ● | |
| 1200 | Corsaro | | 05 - 10 | 2 | ● | |
| 1200 | Corsaro Avio | | 08 - 09 | 2 | ● | |
| 1200 | Corsaro Veloce | | 07 - 09 | 2 | ● | |
| 1200 | Scrambler | | 08 - 10 | 2 | ● | |
| 1200 | Sport | | 08 - 10 | 2 | ● | |

MV AGUSTA

| | | | | | | |
|-----|-----------|--|---------|---|---|--|
| 920 | Brutale | | 11 - | 2 | ● | |
| 989 | Brutale R | | 08 - 09 | 2 | ● | |
| 990 | Brutale R | | 10 - | 2 | ● | |

MZ / MUZ

| | | | | | | |
|------|---|--|---------|---|---|--|
| 1000 | S | | 01 - 02 | 2 | ● | |
|------|---|--|---------|---|---|--|

NORTON

| | | | | | | |
|-----|----------------|--|----|---|---|--|
| 961 | Commando SE | | 10 | 2 | ● | |
| 961 | Commando Sport | | 10 | 2 | ● | |

SACHS

| | | | | | | |
|-----|--------|--|------|---|---|--|
| XTC | 125 | | 08 - | 1 | ● | |
| 125 | X-Road | | 08 | 1 | ● | |

SUZUKI

| | | | | | | |
|-----|-----------------------------|--|---------|---|---|--|
| GSX | 400 X Impulse (GK79A) | | 99 - | 1 | ● | |
| GSX | 400 FSV/FSK1 (GK7B) Inazuma | | 00 - | 1 | ● | |
| GSX | 1200 | | 98 - 01 | 2 | ● | |

VICTORY

| | | | | | | |
|---------|----------------------------|--|---------|---|---|--|
| Kingpin | 1500 | | 04 - 07 | 1 | ● | |
| Kingpin | 1500 Tour | | 04 - 07 | 1 | ● | |
| Touring | 1500 Cruiser | | 05 - | 2 | ● | |
| V92 | 1500 V92C Cruiser / Deluxe | | 98 - 03 | 1 | ● | |
| V92 | 1500 V92SC Sport Cruiser | | 00 - 03 | 2 | ● | |
| Hammer | 1634 | | 05 - 07 | 2 | ● | |
| Hammer | 1634 S | | 07 - 08 | 2 | ● | |
| Vegas | 1634 | | 03 - 07 | 1 | ● | |
| Vegas | 1634 Arlen Ness / Jackpot | | 04 - 07 | 1 | ● | |
| Vegas | 1634 8-Ball | | 05 - 07 | 1 | ● | |

VOXAN

| | | | | | | |
|------|------------------|--|---------|---|---|--|
| 1000 | Black Magic | | 04 - 08 | 2 | ● | |
| VB1 | 1000 EVO | | 03 - 04 | 2 | ● | |
| 1000 | Café-Racer | | 06 - 08 | 2 | ● | |
| 1000 | Roadster | | 06 - 08 | 2 | ● | |
| 1000 | Street Scrambler | | 07 - 08 | 2 | ● | |

YAMAHA

| | | | | | | |
|-----|-----------------------------------|--|---------|---|---|--|
| FZ | 400 R | | 86 - 87 | 2 | ● | |
| XJR | 400 R (Brembo calipers) | | 95 - 99 | 2 | ● | |
| XT | 660 X Supermotard | | 04 - | 1 | ● | |
| TRX | 850 (Japan models) (Brembo Cal.) | | 96 - 99 | 2 | ● | |
| XJR | 1200 (Japan models) (Brembo Cal.) | | 95 - 98 | 2 | ● | |
| XJR | 1300 (Japan models) (Brembo Cal.) | | 98 - 99 | 2 | ● | |

| Street | Sport | Racing | Enduro | MX | Off Road Racing | ATV |
|--------|-------|--------|--------|----|-----------------|-----|
|--------|-------|--------|--------|----|-----------------|-----|

S4 A3+ XBK5 C59

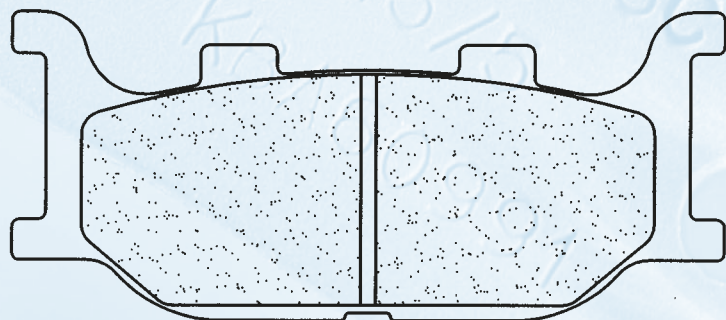

Dim./Size

94 mm

40,7 mm

10 mm

JIANSHE

| | | | | | | |
|----|-----|--|------|---|---|--|
| JS | 125 | | 02 - | 1 | ● | |
|----|-----|--|------|---|---|--|

JINCHENG

| | | | | | | |
|----|---------|--|------|---|---|--|
| JC | 150 T-D | | 06 - | 1 | ● | |
|----|---------|--|------|---|---|--|

KEEWAY

| | | | | | | |
|-----|-------------|--|------|---|---|--|
| 250 | Supershadow | | 06 - | 1 | ● | |
|-----|-------------|--|------|---|---|--|

YAMAHA

| | | | | | | |
|-------|------------------------------------|--|---------|---|---|--|
| SR | 125 | | 97 - 03 | 1 | ● | |
| TDR | 125 (4GW/GX1/2/3/4) | | 93 - 03 | 1 | ● | |
| TZR | 125 (3JB / 4JB / 4HW / 4HX) | | 93 - 95 | 1 | ● | |
| XV | 125 Virago | | 97 - 00 | 1 | ● | |
| XVS | 125 Dragstar | | 00 - 04 | 1 | ● | |
| TZR | 150 (4AP2) | | 00 - | 1 | ● | |
| XV | 250 Virago S | | 95 - 00 | 1 | ● | |
| XVS | 250 Dragstar | | 01 - 03 | 1 | ● | |
| XJR | 400 R | | 93 - 96 | 2 | ● | |
| FZ6 | 600 N / Fazer | | 04 - 07 | 2 | ● | |
| FZ6 | 600 N / Fazer ABS | | 06 - 07 | 2 | ● | |
| XJ | 600 N / S Diversion | | 98 - 03 | 2 | ● | |
| XJ6 | 600 / ABS | | 09 - | 2 | ● | |
| XJ6 | 600 Diversion / ABS | | 09 - | 2 | ● | |
| XJ6 | 600 Diversion F / ABS | | 10 - | 2 | ● | |
| MT-03 | 660 | | 06 - | 2 | ● | |
| XV | 1100 Virago | | 99 | 2 | ● | |
| XVS | 1100 Dragstar / A Dragstar Classic | | 99 - 06 | 2 | ● | |
| XVS | 1100 V-Star Custom | | 05 - | 2 | ● | |
| XVS | 1300 A Midnight Star | | 07 - | 2 | ● | |

Street Sport Racing Enduro MX Off Road Racing ATV

XBK5 C59

PVM

6 Piston Caliper - Racing

1

2584

Dim./Size
→ 102,3 mm
↑ 54,3 mm
H 9 mm

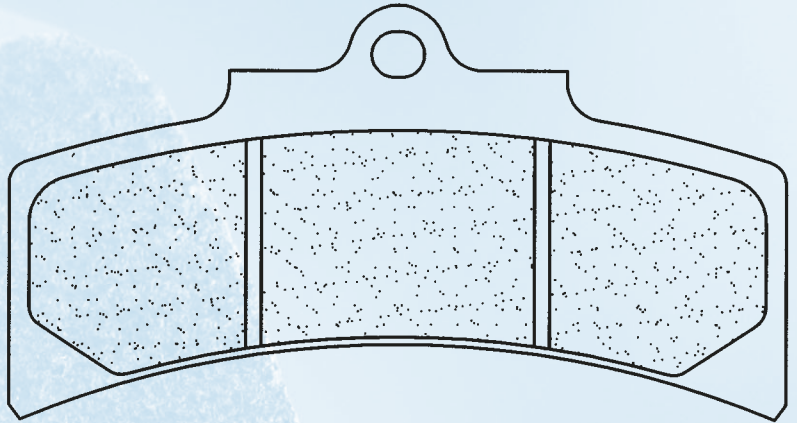

Street Sport Racing Enduro MX Off Road Racing ATV

XBK5 C59

SPIEGLER

8 Piston Caliper - Road/Racing

1

2586

Dim./Size
→ 117 mm
↑ 59,5 mm
H 8 mm

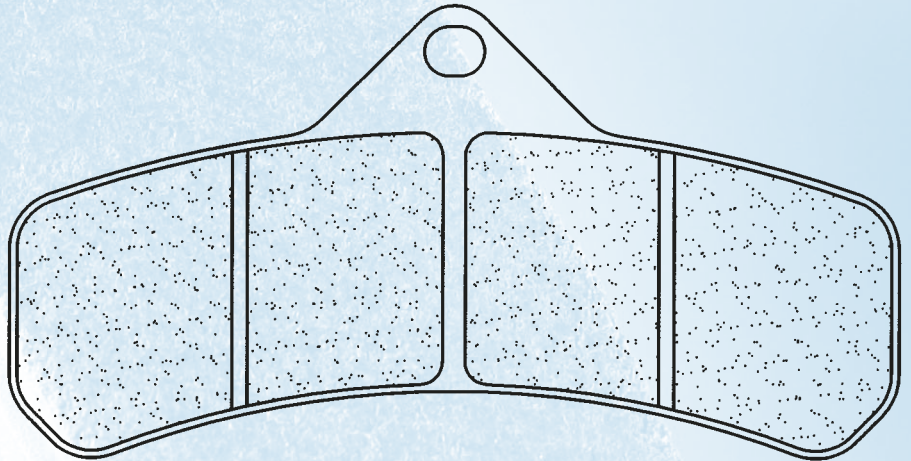

Street Sport Racing Enduro MX Off Road Racing ATV

A3+ RX3

2599

Dim./Size
→ 114,8 mm
↑ 65,7 mm
H 7,2 mm

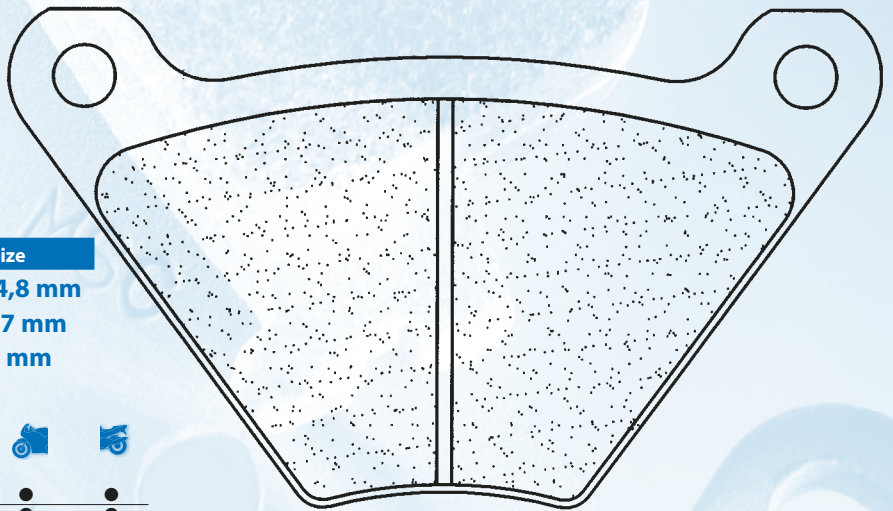

HARLEY DAVIDSON

| | | | | | | |
|------|------|------------------------|---------|---|---|---|
| FL | 1200 | FLH Police | 75 - 79 | 1 | ● | ● |
| FLH | 1200 | Anniversary | 78 | 1 | ● | ● |
| FLH | 1200 | Touring | 77 - 78 | 1 | ● | ● |
| FLH | 1200 | | 80 | 1 | ● | ● |
| FLH | 1200 | | 74 - 76 | 1 | ● | ● |
| FLHS | 1200 | | 77 - 80 | 1 | ● | ● |
| FX | 1200 | | 74 - 80 | | ● | ● |
| FXE | 1200 | | 74 - 80 | | ● | ● |
| FXS | 1200 | | 78 - 79 | | ● | ● |
| FLH | 1340 | 80 | 78 - 80 | 1 | ● | ● |
| FLH | 1340 | 80 | 81 | 1 | ● | ● |
| FLH | 1340 | Electra Glide Speciale | 84 | 1 | ● | ● |
| FLH | 1340 | Electra Glide | 82 - 83 | | ● | ● |
| FXB | 1340 | 80 | 80 - 81 | | ● | ● |

HARLEY DAVIDSON

| | | | | |
|------|------|-------------|---------|---|
| FXB | 1340 | Sturgis | 82 | ● |
| FXE | 1340 | 80 | 78 - 81 | ● |
| FXE | 1340 | Super Glide | 83 | ● |
| FXEF | 1340 | 80 Fat Bob | 79 - 81 | ● |
| FXR | 1340 | | 78 - 81 | ● |
| FXS | 1340 | 80 | 79 - 81 | ● |
| FXS | 1340 | Low Rider | 82 | ● |
| FXWG | 1340 | 80 | 80 - 81 | ● |
| FXWG | 1340 | Wide Glide | 83 | ● |

Street Sport Racing Enduro MX Off Road Racing ATV

S4

MX10

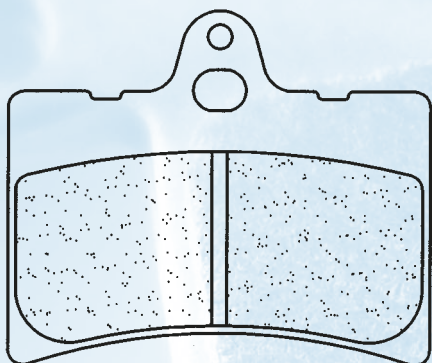

Dim./Size
 ← 55,6 mm
 ↓ 46,6 mm
 H 6 mm

2601

| | | | | |
|---------------|-------|------|---|---|
| BETA | | | | |
| TR | 34 | 92 - | 1 | ● |
| TR | 36 | 92 - | 1 | ● |
| CAGIVA | | | | |
| 50 | Prima | 93 - | 1 | ● |
| 80 | Prima | 92 - | 1 | ● |

Street Sport Racing Enduro MX Off Road Racing ATV

A3+ RX3 XBK5

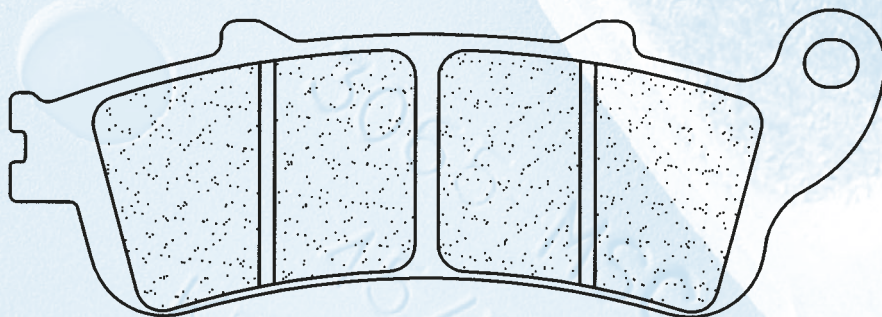

Dim./Size
 ← 115 mm
 ↓ 38,8 mm
 H 8,5 mm

2602

| | | | | | | |
|--------------|------|---------------------|---------|---|---|---|
| HONDA | | | | | | |
| NT | 650 | V Deauville | 02 - 05 | 2 | ● | ● |
| NT | 700 | Deauville / ABS | 06 - | | ● | ● |
| VFR | 800 | FI | 98 - 01 | 2 | ● | ● |
| VFR | 800 | VTEC / VTEC ABS | 02 - 05 | 2 | ● | ● |
| VFR | 800 | VTEC / VTEC ABS | 06 - | | ● | ● |
| XL | 1000 | Varadero | 99 - 06 | 2 | ● | ● |
| XL | 1000 | Varadero Travel | 05 - | 2 | ● | ● |
| XL | 1000 | Varadero | 07 - | | ● | ● |
| XL | 1000 | Varadero ABS | 04 - | | ● | ● |
| XL | 1000 | Varadero Travel ABS | 05 - | | ● | ● |

| | | | | | | |
|----------------|------|----------------------|---------|---|---|---|
| HONDA | | | | | | |
| CB | 1100 | X-11 | 00 - 03 | 2 | ● | ● |
| CBR | 1100 | XX BlackBird | 97 - 98 | 2 | ● | ● |
| ST | 1100 | Pan European ABS-TCS | 96 - 02 | 2 | ● | ● |
| ST | 1300 | Pan European / ABS | 02 - | 2 | ● | ● |
| GL | 1800 | Goldwing | 01 - | 2 | ● | ● |
| NRX | 1800 | Valkyrie Rune | 04 - | 2 | ● | ● |
| VTX | 1800 | | 01 - | 2 | ● | ● |
| VICTORY | | | | | | |
| Vision | 1731 | Arlen Ness Victory | 10 - | 2 | ● | ● |
| Vision | 1731 | Street / Tour | 08 - 10 | 2 | ● | ● |
| Vision | 1731 | 8-Ball | 10 - | 2 | ● | ● |

Street Sport Racing Enduro MX Off Road Racing ATV

S4 A3+ RX3

2621

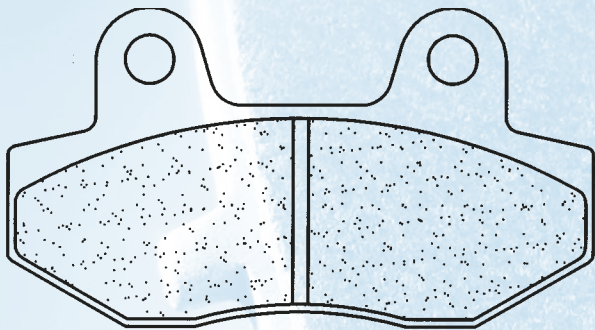

Dim./Size

← 77 mm
↑ ↓ 42 mm
H 8 mm

CAGIVA

| | | | | |
|-----|--------|------|---|---|
| 50 | Mito | 98 - | 1 | ● |
| 116 | Stella | 97 - | 1 | ● |

HONDA

| | | | | | |
|------|----|--------|---------|---|---|
| MBX | 50 | S | 83 - 85 | 1 | ● |
| NS | 50 | F Aero | 88 - | 1 | ● |
| NS-1 | 50 | | 91 - | 1 | ● |

HONDA

| | | | | | |
|-----|-----|----------|---------|---|---|
| NSR | 50 | | 89 - 90 | 1 | ● |
| NSR | 75 | Fil | 88 - 00 | 1 | ● |
| MBX | 80 | | 83 - 86 | 1 | ● |
| MBX | 80 | SW / SWD | 83 - | 1 | ● |
| MBX | 80 | DX | 82 - | 1 | ● |
| NSR | 80 | R | 87 - 92 | 1 | ● |
| CBX | 125 | Custom | 88 | 1 | ● |
| MBX | 125 | RWB | 84 - | 1 | ● |
| CB | 250 | Rebel | 86 - | 1 | ● |
| CMX | 250 | Rebel | 85 - | 1 | ● |
| | 250 | | 86 - | 1 | ● |

HYOSUNG

| | | | | | |
|-----|------|--------------------|---------|---|---|
| GT | 125 | Comet | 02 - | 1 | ● |
| GT | 125 | Comet R | 06 - | 2 | ● |
| GV | 125 | Aquila | 02 - 04 | 1 | ● |
| GV | 125 | Aquila | 05 - | 1 | ● |
| RT | 125 | Karion | 02 - | 1 | ● |
| RX | 125 | | 00 - | 1 | ● |
| RX | 125 | SM | 07 - | 1 | ● |
| XRX | 125 | SM | 07 - | 1 | ● |
| XRX | 125 | Offroad | 99 - 06 | 1 | ● |
| GT | 250 | Comet | 03 - | 1 | ● |
| GT | 250 | R | 07 - | 2 | ● |
| GV | 250 | Aquila | 02 - | 1 | ● |
| XRX | 400 | | 05 - | 1 | ● |
| GT | 600 | Comet | 03 | 2 | ● |
| GT | 650 | Comet | 04 - | 2 | ● |
| GT | 650 | Custom Trendkiller | 07 - | 2 | ● |
| GT | 650 | Comet R / S | 05 - | 2 | ● |
| GT | 650 | TTC | 07 - | 2 | ● |
| GT | 650 | X | 07 - | 2 | ● |
| GV | 650 | Aquila | 04 - 05 | 2 | ● |
| GV | 650 | Aquila | 06 - | 2 | ● |
| GV | 700 | C | 10 - | 1 | ● |
| GV | 1000 | Cruiser | 06 - | 2 | ● |

ITALJET

| | | | | | |
|--|-----|---------|------|---|---|
| | 650 | Bazooka | 06 - | 2 | ● |
| | 650 | Griffon | 06 - | 2 | ● |

KYMCO

| | | | | | |
|----|-----|--------|------|---|---|
| CK | 125 | | 04 - | 1 | ● |
| DX | 150 | Custom | 93 - | 1 | ● |
| | 150 | NSR | 93 - | 1 | ● |

MEGELLI

| | | | | | |
|--|-----|-----------|------|---|---|
| | 125 | M / R / S | 08 - | 1 | ● |
|--|-----|-----------|------|---|---|

SYM

| | | | | | |
|--|-----|-------------|---------|---|---|
| | 125 | Wolf Legend | 04 - 05 | 1 | ● |
|--|-----|-------------|---------|---|---|

Street Sport Racing Enduro MX Off Road Racing ATV

S4 A3+

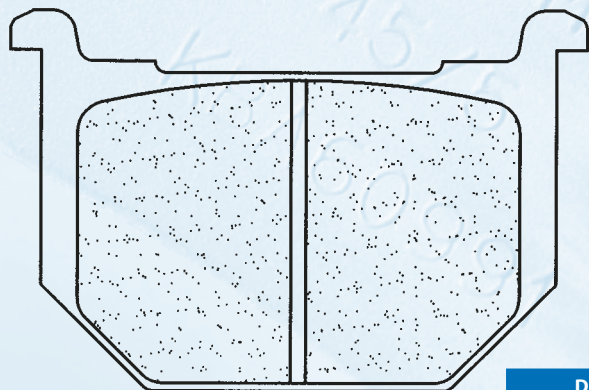

Dim./Size

← 75,8 mm
↑ ↓ 50,2 mm
H 11 mm

SUZUKI

| | | | | | |
|-----|------|---------------------------|---------|---|---|
| GN | 250 | | 85 - 97 | 1 | ● |
| GNX | 250 | E | 82 - | 1 | ● |
| GS | 250 | TT / TX | 80 - 82 | 1 | ● |
| GSX | 250 | | 80 - 82 | 1 | ● |
| GN | 400 | T / TZ / X / XX / TT | 80 - | 1 | ● |
| GSX | 400 | S / L | 80 - | 1 | ● |
| GSX | 400 | ET / EX / EZ | 81 - 83 | 1 | ● |
| GSX | 400 | F | 81 - | 1 | ● |
| GS | 450 | E / S / L | 80 - 83 | 1 | ● |
| GS | 700 | EF / ESF | 85 | 2 | ● |
| GSX | 750 | ET / EX | 80 - 81 | 2 | ● |
| GSX | 750 | ESD/EFE/ESG/ESE/ESH/EFF | 82 - 86 | 2 | ● |
| GS | 850 | GZ / GE / GG | 82 - 85 | 2 | ● |
| GS | 1000 | GT / GX / GLT / GLX | 80 - 81 | 2 | ● |
| GS | 1100 | GD / GZ / GLD / GLZ / GKZ | 82 - 83 | 1 | ● |
| GV | 1200 | GLG Madura | 85 - 86 | 2 | ● |

2694

Street Sport Racing Enduro MX Off Road Racing ATV

S4

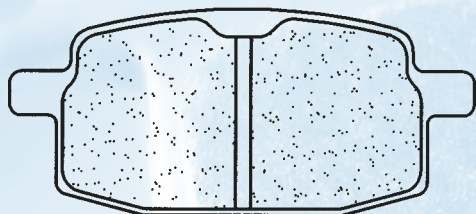

Dim./Size
 — 61 mm
 ↑ 27 mm
 H 7 mm

2696

THUMPSTAR

| | | | | | |
|-----|-------------|---------|---|---|---|
| 90 | Junior | 04 - 06 | 1 | ● | ● |
| 110 | Supa | 04 - 06 | 1 | ● | ● |
| 125 | Expert | 06 | 1 | ● | ● |
| 125 | Pro | 05 - 06 | 1 | ● | ● |
| 125 | Road Ripper | 06 - | 1 | ● | ● |

YAMAHA

| | | | | | |
|-----|----|------|---|---|--|
| TZR | 80 | 92 - | 1 | ● | |
|-----|----|------|---|---|--|

Street Sport Racing Enduro MX Off Road Racing ATV

A3+

2699

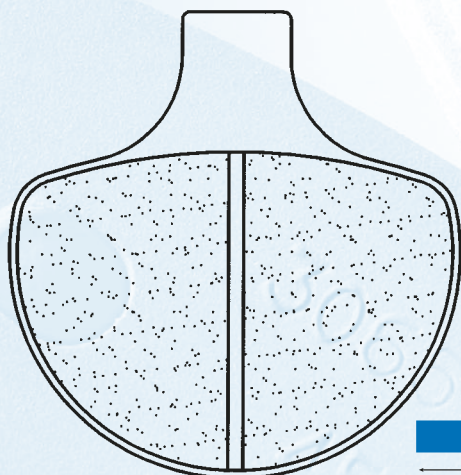

Dim./Size
 — 59,3 mm
 ↑ 61,5 mm
 H 13 mm

HARLEY DAVIDSON

| | | | | | |
|---------|------|---------------------------|---------|---|---|
| FLHT | 1340 | Electra Glide Classic | 87 - 99 | 2 | ● |
| FLHTC | 1340 | Electra Glide Classic | 85 - 86 | 2 | ● |
| FLHTC | 1340 | Electra Glide Classic | 93 | 2 | ● |
| FLHTC | 1340 | Electra Glide Classic | 90 - 99 | 2 | ● |
| FLHTC | 1340 | Ultra Classic | 90 - 99 | 2 | ● |
| FLST | 1340 | Heritage Softail | 86 - 87 | 1 | ● |
| FLST | 1340 | Heritage Softail | 90 - 99 | 1 | ● |
| FLSTC | 1340 | Heritage Softail Classic | 90 - 99 | 1 | ● |
| FLSTF | 1340 | Fat Boy | 90 - 99 | 1 | ● |
| FLSTN | 1340 | Heritage Softail Nost. | 93 - 99 | 2 | ● |
| FLT | 1340 | | 84 - 85 | 1 | ● |
| FLT | 1340 | Series | 88 - 99 | 2 | ● |
| FLT/H | 1340 | Series | 86 - 87 | 2 | ● |
| FLTC | 1340 | Tour Glide Classic | 85 - 86 | 1 | ● |
| FLTC | 1340 | Tour Glide Classic | 90 | 2 | ● |
| FXDB | 1340 | Dyna Glide Daytona | 91 - 99 | 1 | ● |
| FXDB | 1340 | Dyna Glide Sturgis | 91 - 99 | 1 | ● |
| FXDB | 1340 | Sturgis | 91 - 99 | 1 | ● |
| FXDL | 1340 | Dyna Low Rider | 93 - 99 | 2 | ● |
| FXDWG | 1340 | Dyna Wide Glide | 93 - 99 | 1 | ● |
| FXE | 1340 | | 85 - 86 | 1 | ● |
| FXLR | 1340 | Low Rider Custom | 87 - 88 | 1 | ● |
| FXLR | 1340 | Low Rider Custom | 93 - 99 | 1 | ● |
| FXR | 1340 | Sport Glide GTE | 85 - 86 | 2 | ● |
| FXR | 1340 | Super Glide | 85 - 86 | 1 | ● |
| FXR | 1340 | Super Glide | 90 - 99 | 1 | ● |
| FXR | 1340 | | 87 - 88 | 1 | ● |
| FXRS | 1340 | Low Rider | 85 - 86 | 2 | ● |
| FXRS | 1340 | Low Rider Sport | 87 - 99 | 2 | ● |
| FXRS | 1340 | Low Rider Sport Edition | 90 - 99 | 2 | ● |
| FXRS | 1340 | Low Rider Sport, Convert. | 90 - 99 | 2 | ● |
| FXRT | 1340 | Sport Glide | 85 - 86 | 2 | ● |
| FXRT | 1340 | Sport Glide | 90 - 99 | 2 | ● |
| FXST | 1340 | Softail | 84 - 86 | 1 | ● |
| FXSTC | 1340 | Softail Custom | 85 - 86 | 1 | ● |
| FXSTC | 1340 | Softail Custom | 88 - 99 | 1 | ● |
| FXSTS | 1340 | Springer Softail | 90 - 99 | 1 | ● |
| FXTZ | 1340 | Series | 88 | 2 | ● |
| FXWG | 1340 | Wide Glide | 85 - 86 | 1 | ● |
| FXWG | 1340 | | 87 - 88 | 1 | ● |
| | 1340 | Dyna Glide Daytona | 91 - | 1 | ● |
| | 1340 | Dyna Glide Sturgis | 91 - | 2 | ● |
| FLSTS | 1450 | Heritage Springer | 00 - 03 | 1 | ● |
| FLSTSC/ | | | | | |
| FLSTSCI | 1450 | Springer Classic | 05 - | 1 | ● |
| FXSTS/ | | | | | |
| FXSTSI | 1450 | Softail Springer | 00 - 04 | 1 | ● |
| FXSTS/ | | | | | |
| FXSTSI | 1450 | Softail Springer | 05 - | 1 | ● |

HARLEY DAVIDSON

| | | | | | |
|------|------|---------------------|---------|---|---|
| XLH | 883 | Sportster | 85 - 86 | 1 | ● |
| XLH | 883 | Sportster | 87 - 89 | 1 | ● |
| XLH | 883 | Sportster | 90 - 99 | 1 | ● |
| XLH | 1100 | | 87 - 88 | 1 | ● |
| XLH | 1100 | Sportster | 85 - 86 | 1 | ● |
| XLX | 1100 | | 86 | 1 | ● |
| XLH | 1200 | Series | 88 | 2 | ● |
| XLH | 1200 | Sportster | 90 - 99 | 1 | ● |
| FLHS | 1340 | Electra Glide Sport | 90 | 2 | ● |
| FLHT | 1340 | Electra Glide | 85 - 86 | 2 | ● |

Street Sport Racing Enduro MX Off Road Racing ATV

A3+

2700

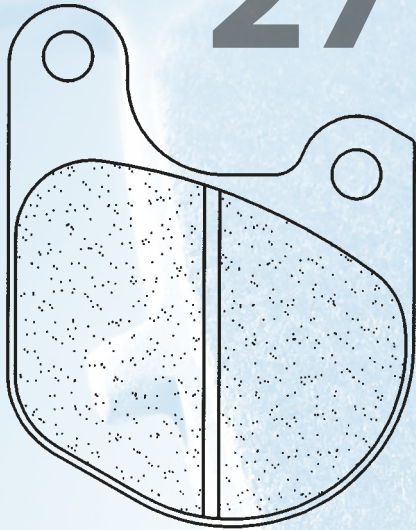

Dim./Size

→ 53,4 mm
↑↓ 68,8 mm
H 6,5 mm

HARLEY DAVIDSON

| | | | | | |
|------|------|----------------|---------|---|---|
| XLH | 883 | | 70 - 83 | 1 | ● |
| XL | 1000 | | 78 | 1 | ● |
| XLCH | 1000 | | 78 - 80 | 1 | ● |
| XLH | 1000 | Roadster | 83 - 85 | 2 | ● |
| XLH | 1000 | Sportster | 79 - 82 | 2 | ● |
| XLH | 1000 | Sportster | 83 - 85 | 2 | ● |
| XLS | 1000 | Anniversary | 82 | 2 | ● |
| XLS | 1000 | Roadster | 79 - 82 | 2 | ● |
| XLS | 1000 | Sportster | 83 | 2 | ● |
| XLX | 1000 | 61 | 83 | 2 | ● |
| XLX | 1000 | 61 | 84 | 1 | ● |
| XR | 1000 | | 85 | 2 | ● |
| FX | 1200 | | 74 - 80 | 1 | ● |
| FXE | 1200 | | 74 - 80 | 1 | ● |
| FXS | 1200 | | 78 - 79 | 1 | ● |
| FLTH | 1340 | Tour Glide | 84 - | 1 | ● |
| FXB | 1340 | 80 | 80 - 81 | 1 | ● |
| FXB | 1340 | Sturgis | 82 | 2 | ● |
| FXE | 1340 | 80 | 78 - 81 | 1 | ● |
| FXE | 1340 | Super Glide | 83 | 1 | ● |
| FXE | 1340 | | 82 | 2 | ● |
| FXEF | 1340 | 80 Fat Bob | 79 - 81 | 1 | ● |
| FXR | 1340 | Super Glide | 82 - 83 | 1 | ● |
| FXR | 1340 | | 78 - 81 | 1 | ● |
| FXRS | 1340 | Low Glide | 82 - 84 | 2 | ● |
| FXRS | 1340 | Super Glide II | 82 - 83 | 2 | ● |
| FXRT | 1340 | Super Glide II | 83 | 1 | ● |
| FXS | 1340 | 80 | 79 - 81 | 1 | ● |
| FXS | 1340 | Low Rider | 82 | 2 | ● |
| FXSB | 1340 | Low Rider | 83 | 2 | ● |
| FXWG | 1340 | 80 | 80 - 81 | 1 | ● |
| FXWG | 1340 | Wide Glide | 82 | 2 | ● |
| FXWG | 1340 | Wide Glide | 83 | 2 | ● |
| FXWG | 1340 | Wide Glide | 84 | 1 | ● |

Street Sport Racing Enduro MX Off Road Racing ATV

RX3

2701

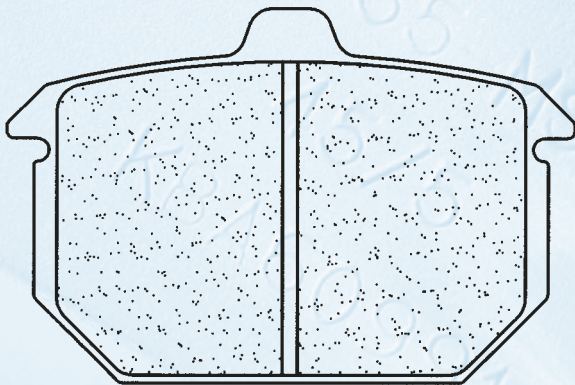

Dim./Size

→ 74,5 mm
↑↓ 49 mm
H 12 mm

HARLEY DAVIDSON

| | | | | | |
|-------|------|-----------------------|---------|--|---|
| XLH | 883 | Sportster | 85 - 86 | | ● |
| XLH | 1000 | Roadster | 83 - 85 | | ● |
| XLH | 1000 | Sportster | 83 - 85 | | ● |
| XLS | 1000 | Anniversary | 82 | | ● |
| XLS | 1000 | Sportster | 83 | | ● |
| XLX | 1000 | 61 | 83 | | ● |
| XLX | 1000 | 61 | 84 | | ● |
| XR | 1000 | | 85 | | ● |
| XLH | 1100 | Sportster | 85 - 86 | | ● |
| XLX | 1100 | | 86 | | ● |
| FLHT | 1340 | Electra Glide | 85 - 86 | | ● |
| FLHTC | 1340 | Electra Glide Classic | 85 - 86 | | ● |
| FLTC | 1340 | Tour Glide Classic | 85 - 86 | | ● |
| FXE | 1340 | | 85 - 86 | | ● |
| FXR | 1340 | Sport Glide GTE | 85 - 86 | | ● |
| FXR | 1340 | Super Glide | 82 - 83 | | ● |
| FXR | 1340 | Super Glide | 85 - 86 | | ● |
| FXRS | 1340 | Low Glide | 82 - 84 | | ● |
| FXRS | 1340 | Low Rider | 85 - 86 | | ● |
| FXRS | 1340 | Super Glide II | 82 - 83 | | ● |
| FXRT | 1340 | Sport Glide | 85 - 86 | | ● |
| FXRT | 1340 | Super Glide II | 83 | | ● |
| FXSB | 1340 | Low Rider | 83 | | ● |
| FXST | 1340 | Softail | 84 - 86 | | ● |
| FXSTC | 1340 | Softail Custom | 85 - 86 | | ● |
| FXWG | 1340 | Wide Glide | 84 | | ● |
| FXWG | 1340 | Wide Glide | 85 - 86 | | ● |
| FXWG | 1340 | | 87 - 88 | | ● |

Street Sport Racing Enduro MX Off Road Racing ATV

RX3

2702

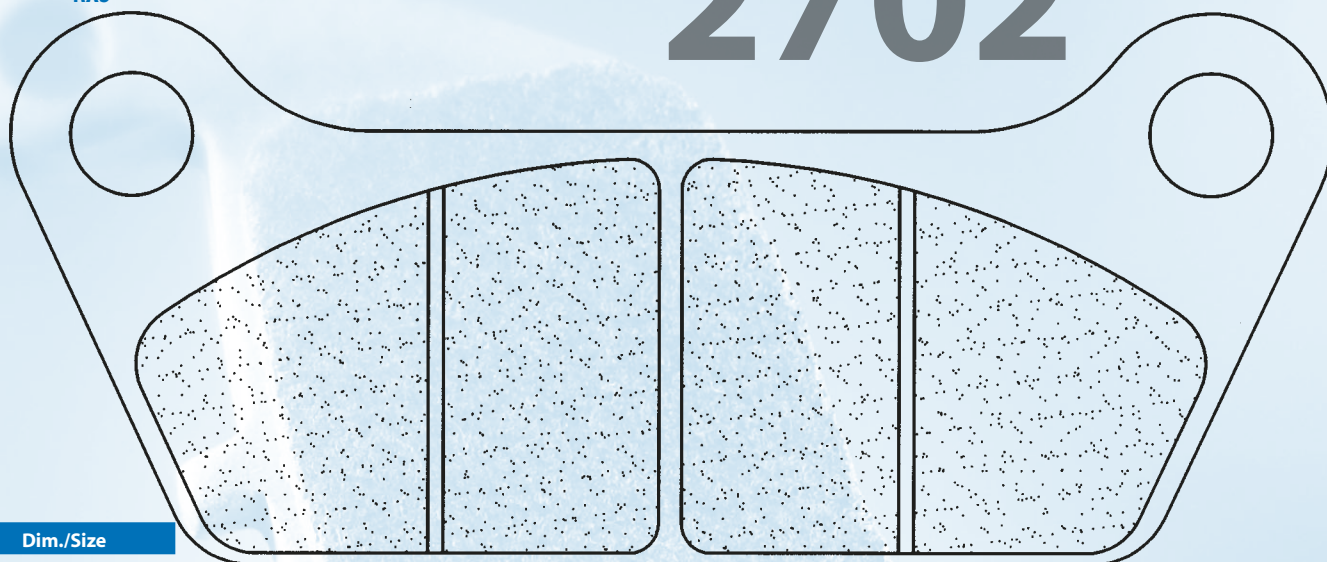

Dim./Size

174,3 mm

72,8 mm

10,4 mm

HARLEY DAVIDSON

| | | | | |
|-----|------|---------|---------|---|
| FLH | 1200 | | 80 | ● |
| FLH | 1340 | 80 | 81 | ● |
| FLH | 1340 | Classic | 82 - 83 | ● |

HARLEY DAVIDSON

| | | | | |
|------|------|------------------------|---------|---|
| FLH | 1340 | Electra Glide Speciale | 84 | ● |
| FLH | 1340 | Heritage | 81 | ● |
| FLT | 1340 | | 84 - 85 | ● |
| FLT | 1340 | 80 | 80 - 81 | ● |
| FLT | 1340 | 80 Classic | 81 | ● |
| FLT | 1340 | Classic | 82 - 83 | ● |
| FLT | 1340 | Tour Glide | 82 | ● |
| FLTH | 1340 | Tour Glide | 84 - | ● |

Street Sport Racing Enduro MX Off Road Racing ATV

A3+ XBK5 C59

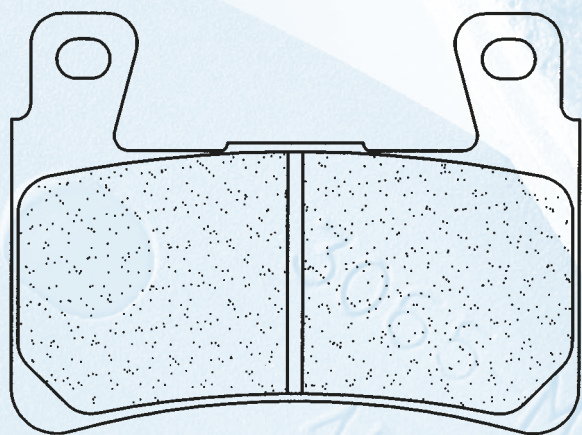

Dim./Size

74,7 mm

55,5 mm

8,2 mm

2711

HARLEY DAVIDSON

| | | | | | |
|--------------|------|----------------------|---------|---|---|
| XR | 1200 | | 08 - | 2 | ● |
| HONDA | | | | | |
| CB | 600 | Hornet (Japan model) | 98 - | 2 | ● |
| CBR | 600 | F 4 / F 4 Sport | 99 - 00 | 2 | ● |
| CBR | 600 | F / FS | 01 - | 2 | ● |
| CBR | 600 | RR | 03 - 04 | 2 | ● |
| CBR | 900 | RR Fireblade | 98 - 99 | 2 | ● |
| CBR | 900 | RR Fireblade (929) | 00 - 01 | 2 | ● |
| CBR | 900 | RR Fireblade (954) | 02 - 03 | 2 | ● |
| VTR | 1000 | SP-1 | 00 - 01 | 2 | ● |
| VTR | 1000 | SP-2 | 02 - 07 | 2 | ● |
| CB | 1300 | F1 | 01 | 2 | ● |
| CB | 1300 | R | 02 - | 2 | ● |
| CB | 1300 | Super Four | 03 - 09 | 2 | ● |
| CB | 1300 | Super Four ABS | 05 - 09 | 2 | ● |

Street Sport Racing Enduro MX Off Road Racing ATV

RX3

2713

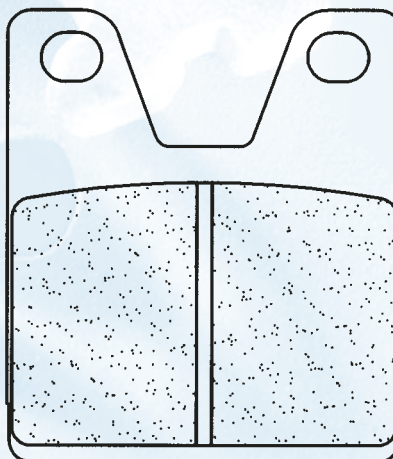

Dim./Size

51,8 mm

59,7 mm

8,6 mm

YAMAHA

| | | | | |
|-----|------|-----------|---------|---|
| YZF | 750 | R7 (OW02) | 99 - 01 | ● |
| YZF | 1000 | R1 | 98 - 01 | ● |

Street Sport Racing Enduro MX Off Road Racing ATV

A3+ RX3

HARLEY DAVIDSON

| | | | | | |
|------|------|---------------|---------|---|---|
| XLH | 883 | | 70 - 83 | | ● |
| XL | 1000 | | 78 | | ● |
| XLCH | 1000 | | 78 - 80 | | ● |
| XLH | 1000 | Sportster | 79 - 82 | | ● |
| XLS | 1000 | Roadster | 79 - 82 | | ● |
| FLH | 1340 | Classic | 82 - 83 | 1 | ● |
| FLH | 1340 | Electra Glide | 82 - 83 | 1 | ● |
| FLH | 1340 | Heritage | 81 | 1 | ● |
| FLT | 1340 | 80 | 80 - 81 | 1 | ● |
| FLT | 1340 | 80 Classic | 81 | 1 | ● |
| FLT | 1340 | Classic | 82 - 83 | 1 | ● |
| FLT | 1340 | Tour Glide | 82 | 1 | ● |

2718

Dim./Size

→ 71,1 mm
↑ 88,9 mm
H 6,6 mm

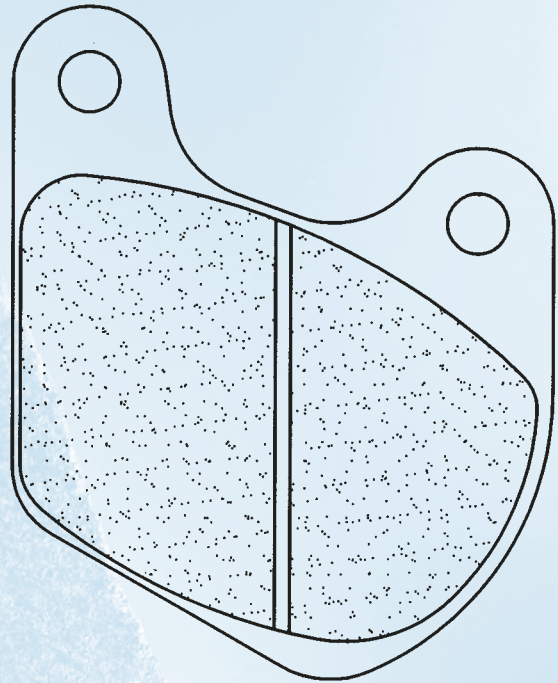

Street Sport Racing Enduro MX Off Road Racing ATV

XBK5 C59

AP RACING

6 Piston Caliper - Road/Racing

1 ●

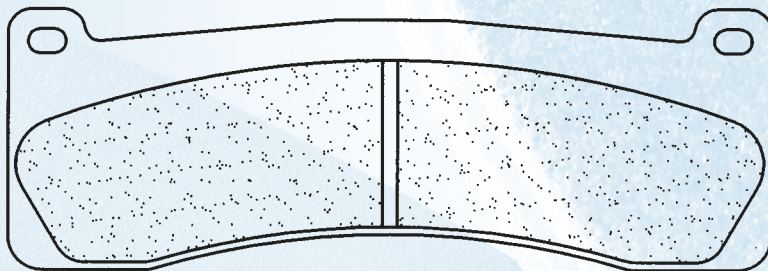

2720

Dim./Size

→ 100,7 mm
↑ 34,4 mm
H 9 mm

Street Sport Racing Enduro MX Off Road Racing ATV

MX10

KAWASAKI

| | | | | | |
|----|-----|--------------|---------|---|---|
| KX | 80 | | 97 - 00 | 1 | ● |
| KX | 85 | | 01 - | 1 | ● |
| KX | 100 | B7 | 97 - | 1 | ● |
| KL | 250 | Super Sherpa | 98 - | 1 | ● |

SUZUKI

| | | | | | |
|----|-----|----|---------|---|---|
| RM | 85 | /L | 05 - 10 | 1 | ● |
| RM | 100 | | 03 | 1 | ● |

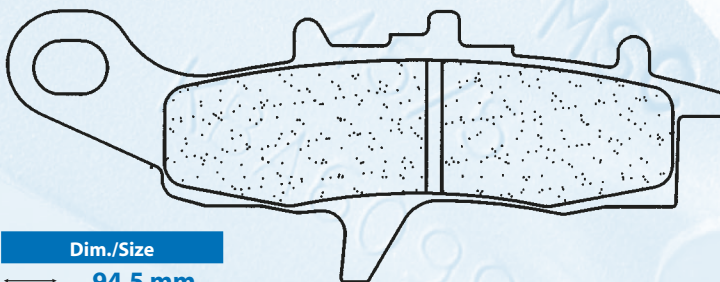

Dim./Size

→ 94,5 mm
↑ 35,5 mm
H 7 mm

2750

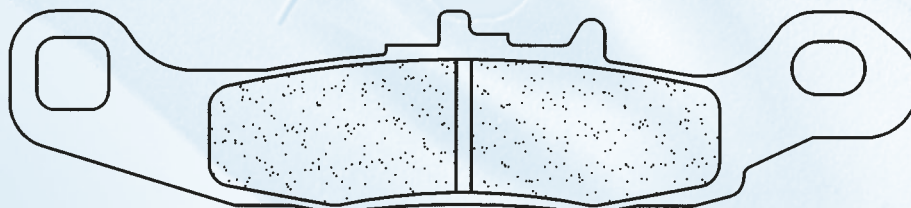

Dim./Size

→ 119,5 mm
↑ 26,5 mm
H 7 mm

Street Sport Racing Enduro MX Off Road Racing ATV

S4

MX10

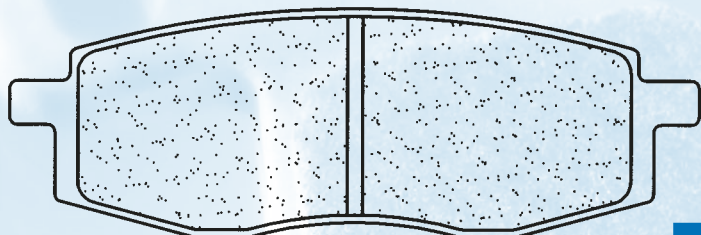

Dim./Size
 ← 90,8 mm
 ↑ 30,2 mm
 H 7,2 mm

2792

| YAMAHA | | | | | |
|--------|-----|-----------------------|---------|---|---|
| YZ | 125 | N / S / T | 85 - 87 | 1 | ● |
| YZ | 125 | U | 88 | 1 | ● |
| IT | 200 | S | 86 | 1 | ● |
| TT | 250 | | 87 - 92 | 1 | ● |
| YZ | 250 | N / S / T (2T) | 85 - 87 | 1 | ● |
| YZ | 250 | U (2T) | 88 | 1 | ● |
| TT | 350 | (1TJ) | 85 - 89 | 1 | ● |
| TT | 350 | A (3GJ) | 90 - 95 | 1 | ● |
| YZ | 490 | N / S / T / U / W / A | 85 - 90 | 1 | ● |
| TT | 600 | | 90 | 1 | ● |

Street Sport Racing Enduro MX Off Road Racing ATV

S4 A3+

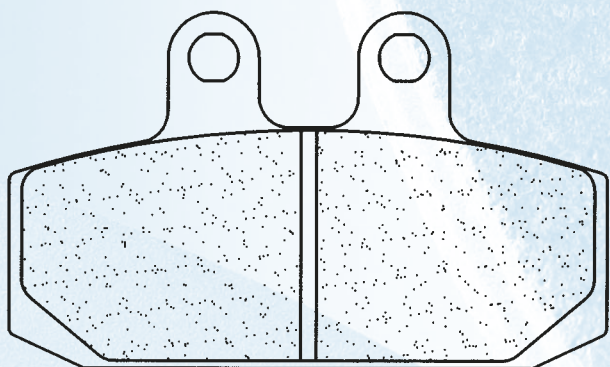

Dim./Size
 ← 78,9 mm
 ↑ 47 mm
 H 7,3 mm

2794

| CAGIVA | | | | | |
|-------------|-----|-------------------|---------|---|---|
| | 50 | Blues | 89 | 1 | ● |
| | 125 | Blues | 92 - 95 | 1 | ● |
| | 125 | Roadster | 94 - | 1 | ● |
| | 200 | Roadster | 96 - | 1 | ● |
| FANTIC | | | | | |
| | 250 | Raider | 85 | 1 | ● |
| GARELLI | | | | | |
| | 125 | Tiger XLE | 86 - | 1 | ● |
| GILERA | | | | | |
| | 125 | Cougar | 99 - | 1 | ● |
| | 125 | Fast Bike | 88 - | 1 | ● |
| | 125 | KK / KR / KZ | 86 - | 1 | ● |
| | 125 | R1 / R1S | 90 - | 1 | ● |
| ER | 125 | Rally | 87 | 1 | ● |
| MXR | 125 | | 90 | 1 | ● |
| RRT | 125 | Nebraska | 87 | 1 | ● |
| RTX | 125 | | 86 | 1 | ● |
| RX | 125 | Arizona Hawk | 85 | 1 | ● |
| X 1 | 125 | | 89 | 1 | ● |
| XR2 | 125 | | 90 | 1 | ● |
| | 200 | Arizona Hawk | 85 | 1 | ● |
| | 200 | ER | 87 | 1 | ● |
| | 200 | Fast Bike | 87 - | 1 | ● |
| | 350 | Dakota | 85 - | 1 | ● |
| XRT | 350 | | 90 - | 1 | ● |
| | 500 | Dakota | 86 | 1 | ● |
| RC | 600 | | 88 | 1 | ● |
| XRT | 600 | | 89 | 1 | ● |
| HONDA | | | | | |
| CA | 125 | Rebel | 97 - | 1 | ● |
| CLR | 125 | CityFly | 98 - | 1 | ● |
| CRM | 125 | / R | 90 - 98 | 1 | ● |
| MTX | 125 | Camel (Italy) | 88 - | 1 | ● |
| MTX | 125 | R (Italy) | 86 | 1 | ● |
| NS | 125 | (Italy) | 85 - 88 | 1 | ● |
| NSR | 125 | F / R | 90 - 92 | 1 | ● |
| NSR | 125 | R (Italy) | 89 - | 1 | ● |
| NX | 125 | Transcity | 90 - 98 | 1 | ● |
| RTV | 125 | NRS (Italy) | 87 - | 1 | ● |
| XL | 125 | R / PD / (Italy) | 85 | 1 | ● |
| XL | 125 | R / PD / Italy EX | 87 - | 1 | ● |
| XL | 200 | R / PD / (Italy) | 85 - | 1 | ● |
| MOTO MORINI | | | | | |
| | 350 | Kanguro | 87 | 1 | ● |
| | 501 | Camel | 88 | 1 | ● |
| SACHS | | | | | |
| ZX | 125 | | 98 - | 1 | ● |
| ZZ | 125 | Funbike | 98 - | 1 | ● |
| SIMSON | | | | | |
| | 125 | SR | 01 - | 1 | ● |

| APRILIA | | | | | |
|---------|-----|--------------|---------|---|---|
| | 125 | Red Rose | 89 | 1 | ● |
| | 125 | Tuareg | - 86 | 1 | ● |
| | 125 | Tuareg Rally | 86 - 88 | 1 | ● |
| | 125 | Tuareg Rally | 89 | 1 | ● |
| ETX | 125 | | - 86 | 1 | ● |
| ETX | 125 | | 86 - 87 | 1 | ● |
| MX | 125 | Cross | 85 | 1 | ● |
| | 250 | Tuareg Rally | 86 - | 1 | ● |
| | 350 | Tuareg | 86 - 87 | 1 | ● |
| | 350 | Tuareg Wind | 87 | 1 | ● |
| ETX | 350 | | - 86 | 1 | ● |
| ETX | 600 | | 86 - | 1 | ● |
| | 600 | Tuareg | 86 - 87 | 1 | ● |

Street Sport Racing Enduro MX Off Road Racing ATV



ATV1

Dim./Size

→ 56 mm
↑ 37,1 mm
H 10,2 mm

2799

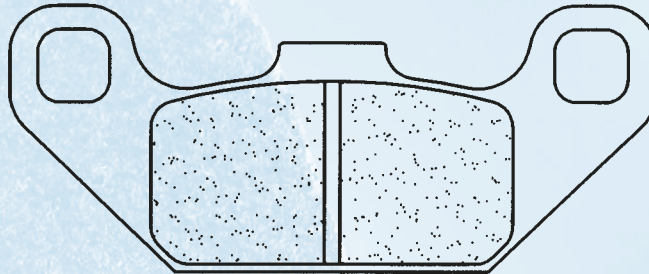
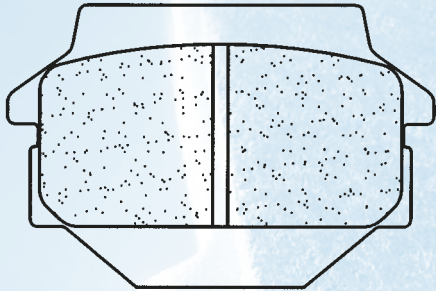

Dim./Size

→ 84,9 mm
↑ 34,9 mm
H 8 mm

KAWASAKI

| | | | | | |
|-----|-----|-----------------|---------|---|---|
| KSF | 250 | A1-A17 Mojave | 87 - | 2 | ● |
| KXF | 250 | A1 / A2 Tecate | 87 - 88 | 2 | ● |
| KXT | 250 | B2 Tecate Trike | 85 - | 1 | ● |
| KEF | 300 | A1-A6 Lakota | 95 - | 2 | ● |

SUZUKI

| | | | | | |
|----|-----|----------------------|---------|---|---|
| LT | 230 | EH/EJ/EK/EL/EM/EN/EP | 86 - 93 | 2 | ● |
| LT | 230 | SF / SG / SH / SJ | 85 - 88 | 2 | ● |
| LT | 250 | RF / RG / RH | 85 - 87 | 2 | ● |
| LT | 250 | RJ/RK/RL/RM/RN | 88 - 94 | 2 | ● |
| LT | 250 | SK / SL | 89 - 90 | 2 | ● |
| LT | 500 | RH / RJ / RK / RL | 87 - 90 | 2 | ● |

Street Sport Racing Enduro MX Off Road Racing ATV

S4 A3+

2801

Dim./Size

→ 119,7 mm
↑ 51,8 mm
H 7,8 mm

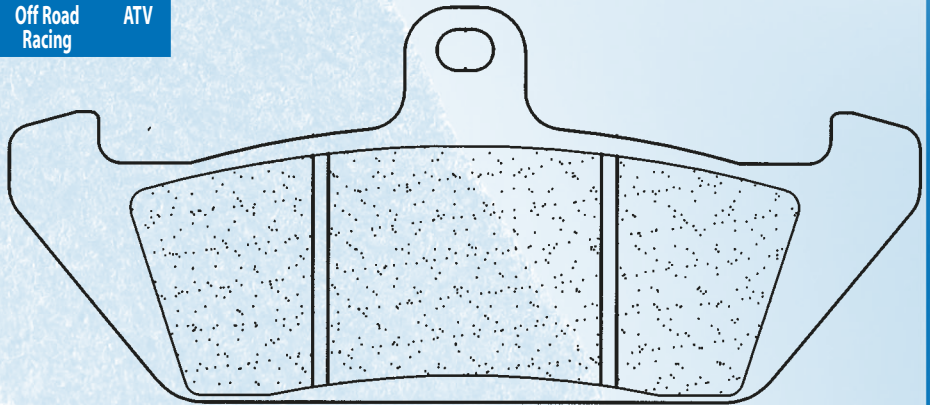

APRILIA

| | | | | |
|-----|-------------|----|---|---|
| 350 | Tuareg Wind | 88 | 1 | ● |
| 600 | Tuareg Wind | 88 | 1 | ● |

CAGIVA

| | | | | |
|-----|----------------|------|---|---|
| 350 | Elefant | 86 - | 1 | ● |
| 650 | Elefant | 86 - | 1 | ● |
| 750 | Lucky Explorer | 88 | 1 | ● |

DUCATI

| | | | | |
|-----|---------|---------|---|---|
| 350 | Indiana | 86 - | 1 | ● |
| 650 | Indiana | 86 - | 1 | ● |
| 750 | Indiana | 87 - 90 | 1 | ● |

LAVERDA

| | | | | | |
|----|-----|-------|------|---|---|
| OR | 600 | Atlas | 86 - | 1 | ● |
|----|-----|-------|------|---|---|

MOTO MORINI

| | | | | |
|-----|-----------|----|---|---|
| 350 | Indiana | 88 | 1 | ● |
| 501 | Excalibur | 89 | 1 | ● |
| 501 | New York | 89 | 1 | ● |
| 650 | Indiana | 88 | 1 | ● |
| 750 | Indiana | 88 | 1 | ● |

Street Sport Racing Enduro MX Off Road Racing ATV

S4 A3+

2802

Dim./Size

→ 68 mm
↑ 58,6 mm
H 10,7 mm

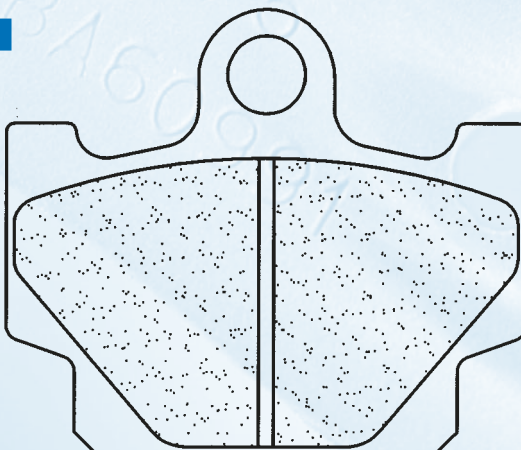

YAMAHA

| | | | | | |
|----|-----|-----------------|---------|---|---|
| DT | 80 | LC (37A) | 81 - 84 | 1 | ● |
| RD | 80 | LC | 81 - 82 | 1 | ● |
| RX | 100 | | 84 - | 1 | ● |
| RX | 115 | S | 82 - 84 | 1 | ● |
| RD | 125 | LC | 82 - 84 | 1 | ● |
| SR | 125 | SE | 92 - 96 | 1 | ● |
| RX | 135 | (13X) | 81 | 1 | ● |
| XV | 240 | Virago | 92 - | 1 | ● |
| RD | 250 | LC | 83 - | 1 | ● |
| RZ | 250 | (4L3) | 80 - | 1 | ● |
| RZ | 250 | R (29L) | 80 - | 2 | ● |
| SR | 250 | Classic | 96 - 00 | 1 | ● |
| XV | 250 | Virago | 88 - 90 | 1 | ● |
| XV | 250 | Virago | 93 - 95 | 1 | ● |
| RD | 350 | YPVS | 83 - 84 | 2 | ● |
| RZ | 350 | L / N / NC | 84 - 85 | 2 | ● |
| XJ | 400 | | 82 | 2 | ● |
| XS | 400 | DOHC | 82 | 1 | ● |
| XS | 400 | RJ / RK / J / K | 83 - 83 | 1 | ● |
| XS | 500 | DOHC | 82 - | 1 | ● |
| XV | 500 | | 83 - | 1 | ● |
| XZ | 550 | | 82 - 84 | 2 | ● |
| XT | 600 | | 84 - 86 | 1 | ● |
| XT | 600 | Z Ténéré | 84 | 1 | ● |
| XJ | 650 | LK Seca | 83 | 2 | ● |
| XJ | 650 | Turbo | 82 | 2 | ● |

Street Sport Racing Enduro MX Off Road Racing ATV

S4 A3+

| YAMAHA | | Enduro | MX | Off Road Racing | ATV |
|--------|---------------------------------|---------|----|-----------------|-----|
| RD | 50 / MX | 81 - 87 | 1 | ● | |
| RD | 80 Air Cooled | 81 - | 1 | ● | |
| RX | 80 SE | 82 - | 1 | ● | |
| RD | 250 LC | 81 - 82 | 1 | ● | |
| RD | 350 LC (4LO) | 81 - 82 | 2 | ● | |
| XJ | 550 | 81 - 84 | 2 | ● | |
| XJ | 550 H/J/K/RH/RJ/RK Maxim / Seca | 81 - 83 | 1 | ● | |
| XJ | 750 RH / RJ / RK / Seca / Maxim | 81 - 83 | 2 | ● | |
| XJ | 750 | 82 - 84 | 2 | ● | |
| XV | 920 J Virago | 82 | 2 | ● | |
| XJ | 1100 Maxim | 81 - | 2 | ● | |
| XS | 1100 S | 81 | 2 | ● | |

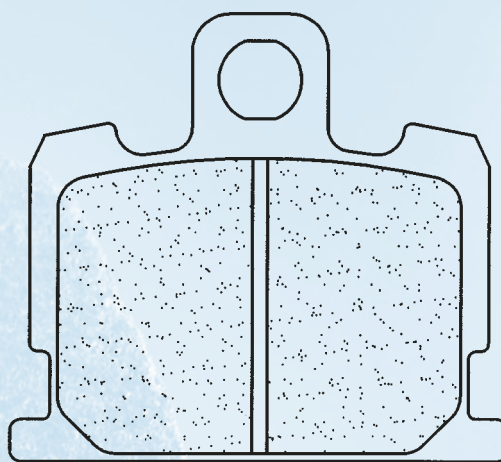

Dim./Size
 → 66 mm
 ↑ 59 mm
 H 10 mm

2807

Street Sport Racing Enduro MX Off Road Racing ATV

RX3

2813

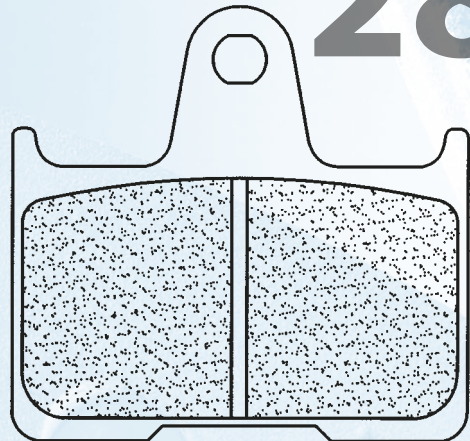

Dim./Size
 → 59,7 mm
 ↑ 57,1 mm
 H 8 mm

| HONDA | | Enduro | MX | Off Road Racing | ATV |
|----------|-------------------------------|---------|----|-----------------|-----|
| CB | 1300 X-4 | 97 - 00 | | ● | |
| CB | 1300 SF | 98 - 00 | | ● | |
| CB | 1300 F1 | 01 | | ● | |
| CB | 1300 R | 02 - | | ● | |
| KAWASAKI | | | | | |
| ZX7-RR | 750 Ninja | 96 - 02 | | ● | |
| GTR | 1400 (Rad.Cal) | 07 - | | ● | |
| ZZR | 1400 (Rad.Cal) | 06 - | | ● | |
| MZ / MUZ | | | | | |
| | 1000 S | 03 - 07 | | ● | |
| | 1000 SF | 05 - 07 | | ● | |
| | 1000 SFX | 07 - | | ● | |
| | 1000 SN | 05 - | | ● | |
| | 1000 ST | 07 - | | ● | |
| SUZUKI | | | | | |
| GSX-R | 600 K4 / K5 (Rad.cal) | 04 - 05 | | ● | |
| GSF | 650 Bandit / Bandit S | 05 - 06 | | ● | |
| GSF | 650 Bandit ABS / Bandit S ABS | 05 - 06 | | ● | |
| GSX-R | 750 K4 / K5 (Rad.cal) | 04 - 05 | | ● | |
| GSX-R | 1000 K1 / K2 | 01 - 02 | | ● | |
| GSX-R | 1000 K3 (Rad.cal) | 03 | | ● | |
| GSX-R | 1000 K4 (Rad.cal) | 04 | | ● | |
| GSX-R | 1000 K5 / K6 (Rad.cal) | 05 - 06 | | ● | |
| GS | 1200 SS (GV78A) | 01 | | ● | |
| GSX | 1400 | 01 - 07 | | ● | |

Street Sport Racing Enduro MX Off Road Racing ATV

S4 A3+ RX3

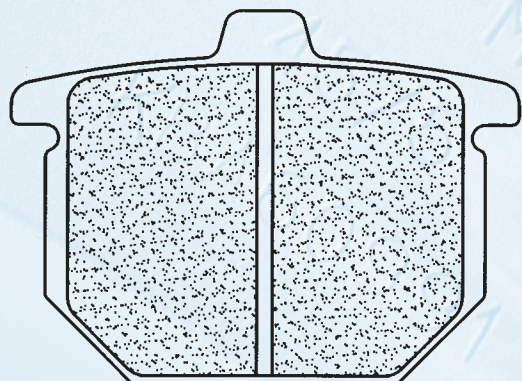

Dim./Size
 → 66,9 mm
 ↑ 49,1 mm
 H 9,5 mm

| HONDA | | Enduro | MX | Off Road Racing | ATV |
|-------|-----------------------------|---------|----|-----------------|-----|
| MT | 125 R | 78 - | 1 | ● | |
| CB | 400 N | 78 - 81 | 1 | ● | |
| CB | 400 NZ | - 79 | 1 | ● | |
| CX | 400 | 81 | 1 | ● | |
| GL | 400 | 77 - 80 | 1 | ● | |
| CX | 500 | 78 - 80 | 1 | ● | |
| CB | 750 F | 77 - 80 | 2 | ● | ● |
| CB | 750 SS | 77 - 79 | | ● | ● |
| CB | 900 F | 78 - 80 | 2 | ● | ● |
| CBX | 1000 | 78 - 80 | 2 | ● | ● |
| GL | 1000 Goldwing | 81 - | 2 | ● | ● |
| GL | 1000 Grand Touring Goldwing | 81 - | 2 | ● | ● |
| GL | 1000 K3 Goldwing | 78 - 79 | 2 | ● | ● |
| GL | 1100 A Goldwing | 79 - 81 | 2 | ● | ● |

2814

Street Sport Racing Enduro MX Off Road Racing ATV

RX3

ATV1

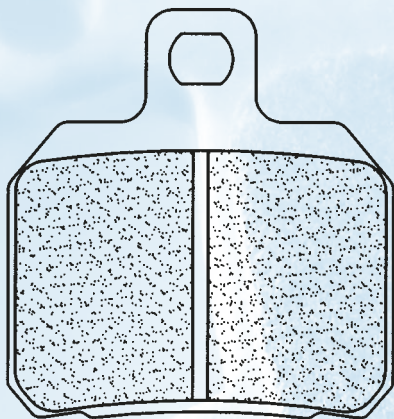

Dim./Size

→ 50,7 mm
↑ 53,8 mm
H 7,8 mm

2827

APRILIA

| | | | | |
|------|------|---------------------|---------|---|
| ETV | 1000 | Caponord | 01 - | ● |
| ETV | 1000 | Caponord Rally Raid | 04 - | ● |
| RSV | 1000 | | 97 - 01 | ● |
| RSV | 1000 | | 02 - | ● |
| RSV | 1000 | Factory Pista | 04 - | ● |
| RSV | 1000 | Nera | 04 - | ● |
| RSV | 1000 | R | 00 | ● |
| RSV | 1000 | R | 01 - 02 | ● |
| RSV | 1000 | R | 03 - | ● |
| RSV | 1000 | R Factory Replica | 04 - | ● |
| RSV | 1000 | SP | 00 - | ● |
| RSV | 1000 | Tuono Fighter | 03 - 05 | ● |
| RSV | 1000 | Tuono R | 03 | ● |
| RSV | 1000 | Tuono R Factory | 04 - | ● |
| RSV4 | 1000 | Factory | 09 - | ● |
| RSV4 | 1000 | R | 10 - | ● |
| SL | 1000 | Falco | 00 - | ● |

BENELLI

| | | | | |
|-------|------|----------------------------|---------|---|
| 2ue | 756 | Cue | 07 - 09 | ● |
| 2ue | 756 | Cue | 10 - | ● |
| Tre-K | 899 | | 07 - | ● |
| TnT | 899 | / Sport | 07 - | ● |
| | 900 | Tornado Tre | 03 - | ● |
| | 900 | Tornado Tre RS (Rad. cal.) | 04 - | ● |
| TNT | 1130 | | 05 - | ● |
| TNT | 1130 | Café Racer | 05 - | ● |
| TNT | 1130 | Officine | 07 - | ● |
| TNT | 1130 | Sport / Titanium | 05 - | ● |
| | 1130 | Tornado | 08 - | ● |
| Tre-K | 1130 | | 06 - | ● |
| Tre-K | 1130 | Amazonas | 07 - | ● |

BIMOTA

| | | | | |
|------|------|------------|------|---|
| DB5 | 1000 | Mille | 05 - | ● |
| DB5 | 1000 | R | 07 - | ● |
| DB5 | 1000 | S | 07 - | ● |
| DB6 | 1000 | Delirio | 07 - | ● |
| DB7 | 1098 | (Rad. Cal) | 08 - | ● |
| 3D | 1100 | Tesi | 07 - | ● |
| DB6R | 1100 | Delirio | 08 - | ● |

BOMBARDIER

| | | | | | |
|--|-----|-------------|---------|---|---|
| | 500 | Traxter 4x4 | 99 - 01 | 2 | ● |
|--|-----|-------------|---------|---|---|

CAGIVA

| | | | | |
|--|------|-------------|------|---|
| | 650 | Raptor | 01 - | ● |
| | 650 | V-Raptor | 01 - | ● |
| | 1000 | Raptor | 00 - | ● |
| | 1000 | V-Raptor | 00 - | ● |
| | 1000 | Xtra Raptor | 02 - | ● |
| | 1000 | X-Raptor | 03 - | ● |
| | 1000 | X3 Raptor | 04 - | ● |

DERBI

| | | | | |
|--|-----|---------------|------|---|
| | 659 | Mulhacén | 05 | ● |
| | 659 | Mulhacén | 06 - | ● |
| | 659 | Mulhacén Cafe | 08 - | ● |

DUCATI

| | | | | |
|------------------|------|--------------------------|---------|---|
| | 620 | Multistrada | 05 - | ● |
| | 620 | Multistrada Dark | 05 - | ● |
| | 620 | Sport | 03 - | ● |
| M | 696 | Monster | 08 - | ● |
| | 749 | / S | 03 - | ● |
| | 749 | R / Dark | 04 - | ● |
| | 750 | Sport / Supersport | 00 - 02 | ● |
| | 796 | Hypermotard | 10 - | ● |
| | 796 | Monster | 10 - | ● |
| | 800 | Sport / Supersport | 03 | ● |
| | 800 | Supersport | 04 | ● |
| | 848 | | 08 - | ● |
| MH | 900 | e | 01 - | ● |
| | 900 | Monster / Monster i.e | 00 - 02 | ● |
| | 900 | Supersport | 98 - 02 | ● |
| | 916 | ST4 | 99 - 01 | ● |
| | 944 | ST2 | 97 - 03 | ● |
| D16RR | 990 | Desmosedici RR | 07 | ● |
| | 992 | ST3 | 04 - | ● |
| | 992 | ST3s ABS | 06 - | ● |
| | 996 | ST4s | 02 - | ● |
| | 996 | ST4s ABS | 03 - | ● |
| | 998 | Monster S4RS | 06 | ● |
| | 999 | Monster S4R/RS | 07 - 08 | ● |
| | 999 | / S / R | 03 - | ● |
| | 999 | R Xerox | 06 - | ● |
| SportClassic1000 | | Sport / Biposto | 07 - | ● |
| SportClassic1000 | | GT | 05 - | ● |
| SportClassic1000 | | GT Touring | 09 - | ● |
| | 1000 | Hypermotard | 06 - | ● |
| | 1000 | Monster S2R | 06 - 08 | ● |
| | 1000 | Monster S4R | 06 - | ● |
| | 1000 | Monster S4Rs Testatretta | 06 - | ● |
| | 1000 | Multistrada DS | 03 - 05 | ● |
| | 1000 | Multistrada S DS | 05 - 06 | ● |
| | 1098 | / S | 07 - 08 | ● |
| | 1098 | R | 08 | ● |
| | 1098 | R Bayliss LE | 09 | ● |
| | 1098 | Streetfighter | 09 - | ● |
| | 1098 | Streetfighter S | 09 - | ● |
| | 1100 | Hypermotard | 07 - | ● |
| | 1100 | Hypermotard S | 07 - | ● |
| | 1100 | Hypermotard Evo / SP | 10 - | ● |
| | 1100 | Monster / Monster S | 09 - | ● |
| | 1100 | Multistrada | 07 - | ● |
| | 1100 | Multistrada S | 07 - | ● |
| | 1198 | / S / R Corse | 09 - | ● |
| | 1200 | Multistrada / S | 10 - | ● |

GILERA

| | | | | |
|--|-----|------------|------|---|
| | 600 | Supersport | 03 - | ● |
|--|-----|------------|------|---|

KTM

| | | | | |
|------|------|---|------|---|
| RC-8 | 1190 | | 08 - | ● |
| RC8 | 1190 | R | 09 - | ● |

LAVERDA

| | | | | |
|-----|------|------------|------|---|
| TTS | 800 | | 99 - | ● |
| SFC | 1000 | (Rad.cal.) | 04 - | ● |

MONDIAL

| | | | | |
|--|------|-------------------------|------|---|
| | 1000 | Evo (Rad. Cal.) | 04 - | ● |
| | 1000 | Piega | 03 - | ● |
| | 1000 | RZ Nuda | 04 - | ● |
| | 1000 | Starfighter (Rad. Cal.) | 04 - | ● |

MOTO GUZZI

| | | | | |
|----|------|----------------------|---------|---|
| V7 | 744 | Classic | 08 - | ● |
| V7 | 744 | Café Classic | 09 - | ● |
| | 750 | Breva i.e | 03 - | ● |
| | 750 | Nevada Club | 98 - 01 | ● |
| | 750 | Nevada / Nevada Club | 03 - 04 | ● |
| | 750 | Nevada Classic i.e | 05 - | ● |
| | 750 | Nevada Touring | 07 - | ● |
| V7 | 750 | Clubman Racer | 10 - | ● |
| | 1200 | Corsa MGS-01 | 07 - | ● |

MOTO MORINI

| | | | | |
|--|------|----------------|---------|---|
| | 998 | 9 1/2 | 06 - 10 | ● |
| | 1187 | MM3 | 07 | ● |
| | 1200 | Corsaro | 05 - 10 | ● |
| | 1200 | Corsaro Avio | 08 - 09 | ● |
| | 1200 | Corsaro Veloce | 07 - 09 | ● |
| | 1200 | Scrambler | 08 - 10 | ● |
| | 1200 | Sport | 08 - 10 | ● |

NORTON

| | | | | |
|--|-----|---------------------|----|---|
| | 961 | Commando Café Racer | 10 | ● |
| | 961 | Commando SE | 10 | ● |
| | 961 | Commando Sport | 10 | ● |

VOXAN

| | | | | |
|-----|------|------------------|---------|---|
| VB1 | 1000 | EVO | 03 - 04 | ● |
| | 1000 | Black Magic | 04 - 08 | ● |
| | 1000 | Café-Racer | 02 - 05 | ● |
| | 1000 | Café-Racer | 06 - 08 | ● |
| | 1000 | Cyclope | 02 | ● |
| | 1000 | Roadster | 02 - 05 | ● |
| | 1000 | Roadster | 06 - 08 | ● |
| | 1000 | Street Scrambler | 03 - 05 | ● |
| | 1000 | Street Scrambler | 07 - 08 | ● |
| | 1200 | GTV | 08 - | ● |

Street Sport Racing Enduro MX Off Road Racing ATV

S4 RX3

YAMAHA

| | | | | | | |
|-----|------|---------------|---------|---|---|---|
| TW | 125 | | 99 - 02 | 1 | ● | |
| TW | 125 | R / S | 03 - 04 | 1 | ● | |
| TW | 200 | | 01 - 02 | 1 | ● | |
| ST | 225 | Bronco | 97 | 1 | ● | |
| TW | 225 | | 03 | 1 | ● | |
| XT | 225 | | 05 - | 1 | ● | |
| XG | 250 | Tricker | 04 - 06 | 1 | ● | |
| XT | 250 | X Supermotard | 06 - 08 | 1 | ● | |
| YZF | 600 | R6 | 99 - 02 | | | ● |
| YZF | 1000 | R1 | 02 - 03 | | | ● |

Dim./Size
→ 99,8 mm
↑ 31 mm
H 9 mm

2828

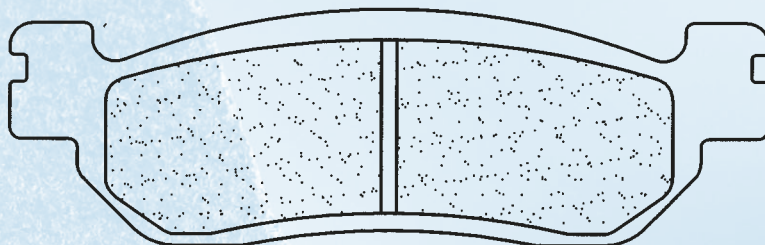

Street Sport Racing Enduro MX Off Road Racing ATV

A3+

BENELLI

| | | | | | | |
|------------|------|----|---------|---|---|--|
| 900 | Sei | | 81 - 83 | 2 | ● | |
| BMW | | | | | | |
| R65/1 | 650 | | 86 - | 1 | ● | |
| R80 | 800 | GS | 88 - 93 | 1 | ● | |
| K100 | 1000 | GS | 87 - 93 | 1 | ● | |
| R100 | 1000 | RT | 91 - | 2 | ● | |

Dim./Size
→ 59,6 mm
↑ 58,5 mm
H 9 mm

2840

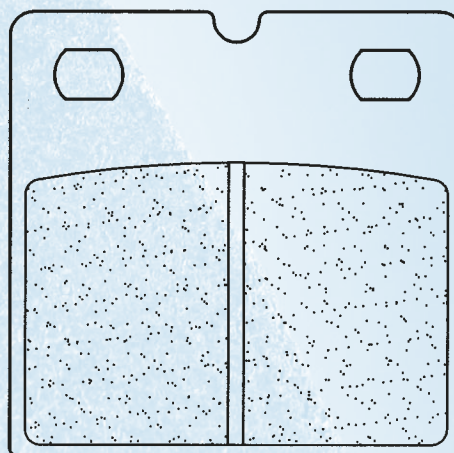

Street Sport Racing Enduro MX Off Road Racing ATV

S4 A3+ RX3

2847

YAMAHA

| | | | | | | |
|----|------|------------------|---------|---|---|---|
| XS | 250 | C | 77 - 78 | 1 | ● | ● |
| XS | 250 | D / E | 79 - 81 | 1 | ● | |
| XS | 360 | C / D | 76 - | 1 | ● | ● |
| XS | 400 | C / E / F | 77 - 79 | 1 | ● | ● |
| SR | 500 | | 78 - 82 | 1 | ● | |
| XS | 500 | C / D | 78 - 79 | 1 | ● | ● |
| XJ | 650 | | 80 - 84 | 2 | ● | |
| XJ | 650 | RJ Seca | 82 | 2 | ● | |
| XS | 650 | D1E / F / F2 | 77 - 79 | 2 | ● | |
| XS | 650 | SE | 79 - 80 | 1 | ● | ● |
| XS | 650 | SE | 81 | 1 | ● | |
| XS | 650 | G / H / J / K | 80 - 82 | 2 | ● | |
| XS | 650 | SJ / SK Heritage | 82 - | 1 | ● | |
| XS | 750 | | 77 - 79 | 2 | ● | ● |
| XS | 750 | SE | 79 - 80 | | | ● |
| XS | 850 | | 80 | 2 | ● | ● |
| XV | 1000 | TR1 | 81 - | 2 | ● | |
| XS | 1100 | | 78 - 80 | 1 | ● | ● |
| XS | 1100 | S | 81 | | | ● |

Dim./Size
→ 67,3 mm
↑ 49,9 mm
H 11 mm

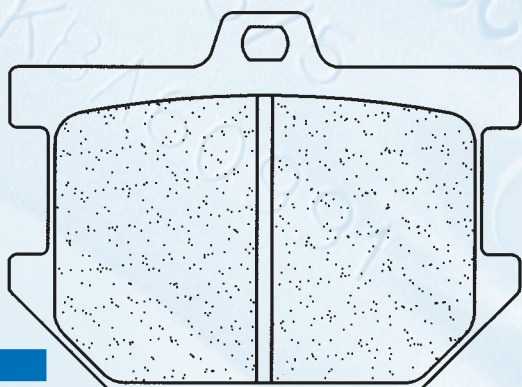

Street Sport Racing Enduro MX Off Road Racing ATV

A3+ XBK5 C59

BUELL

| | | | | | |
|-----|------|---------------|---------|---|---|
| M2 | 1200 | Cyclone | 98 - 02 | 1 | ● |
| S1 | 1200 | Lightning | 98 - 02 | 1 | ● |
| S1 | 1200 | Whitelighting | 98 - 02 | 1 | ● |
| S3 | 1200 | Thunderbolt | 98 - 02 | 1 | ● |
| S3T | 1200 | Thunderbolt | 98 - 02 | 1 | ● |
| X1 | 1200 | Lightning | 98 - 02 | 1 | ● |

HONDA

| | | | | | |
|----|------|----|---------|---|---|
| CB | 1300 | SF | 98 - 00 | 2 | ● |
|----|------|----|---------|---|---|

KAWASAKI

| | | | | | |
|--------|-----|-------|---------|---|---|
| ZX7-RR | 750 | Ninja | 96 - 02 | 2 | ● |
|--------|-----|-------|---------|---|---|

MV AGUSTA

| | | | | | |
|------|-------------------------------|--|---------|---|---|
| 750 | Brutale (All Models) (Nissin) | | 03 - 08 | 2 | ● |
| 750 | F4 (All Models) (Nissin) | | 99 - 03 | 2 | ● |
| 910 | Brutale S (Nissin) | | 05 - 08 | 2 | ● |
| 1000 | F4 (All Models) (Nissin) | | 04 - 06 | 2 | ● |

YAMAHA

| | | | | | |
|-----|-----|----------------------|---------|---|---|
| YZF | 750 | R7 (OW02) "Race Kit" | 99 - 01 | 2 | ● |
|-----|-----|----------------------|---------|---|---|

NISSIN

| | | | | | |
|--------------------------------|--|--|--|---|---|
| 6 Piston Caliper - Road/Racing | | | | 1 | ● |
|--------------------------------|--|--|--|---|---|

PERFORMANCE MACHINE

| | | | | | |
|------------------------------------------|--|--|--|---|---|
| Caliper 112x6 QC = 0051-2901/2902 - Road | | | | 1 | ● |
|------------------------------------------|--|--|--|---|---|

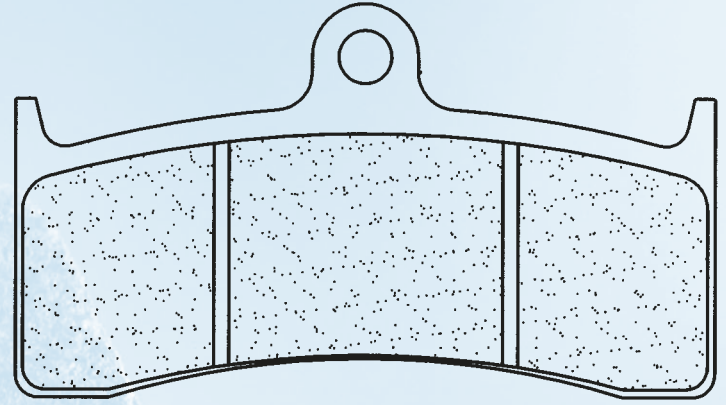
Dim./Size

→ 91,7 mm
 ↓ 51,6 mm
 H 8,2 mm

2899

Street Sport Racing Enduro MX Off Road Racing ATV

RX3

2900

Dim./Size

→ 94 mm
 ↓ 36 mm
 H 10,1 mm

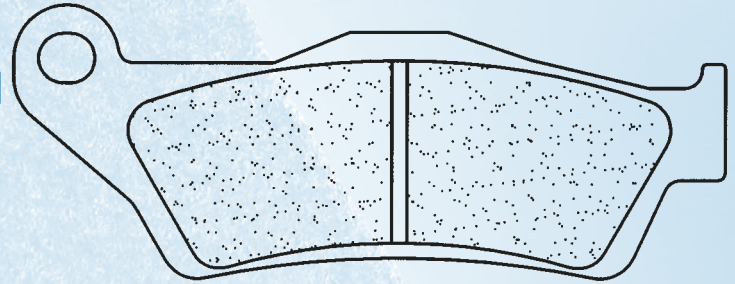
BMW

| | | | | | |
|---|------|------------------------|---------|--|---|
| F | 800 | ST | 06 - | | ● |
| R | 850 | C | 98 - | | ● |
| R | 850 | GS | 98 - | | ● |
| R | 850 | R | 95 - 02 | | ● |
| R | 850 | R | 03 - | | ● |
| R | 850 | RT | 98 - 00 | | ● |
| R | 850 | RT ABS | 01 - | | ● |
| S | 1000 | RR | 09 - | | ● |
| R | 1100 | GS | 95 - 99 | | ● |
| R | 1100 | GS | 00 - 01 | | ● |
| R | 1100 | GS ABS | 95 - 01 | | ● |
| R | 1100 | R | 95 - | | ● |
| R | 1100 | RS | 94 - | | ● |
| R | 1100 | RT | 95 - | | ● |
| R | 1100 | RT ABS | 95 - | | ● |
| R | 1100 | S | 99 - 00 | | ● |
| R | 1100 | S (Brembo Caliper) | 01 - | | ● |
| R | 1100 | S ABS (Tokico Caliper) | 01 - | | ● |
| R | 1150 | GS | 00 - 01 | | ● |
| R | 1150 | GS / GS Adventure | 02 - | | ● |
| R | 1150 | R | 01 - | | ● |
| R | 1150 | R Rockster | 03 - | | ● |

BMW

| | | | | | |
|-----|------|----------|------|--|---|
| R | 1150 | RS | 01 - | | ● |
| R | 1150 | RT ABS | 01 - | | ● |
| HP2 | 1200 | Enduro | 06 - | | ● |
| HP2 | 1200 | Megamoto | 07 - | | ● |
| K | 1200 | R Sport | 07 - | | ● |
| K | 1200 | GT ABS | 05 - | | ● |
| K | 1200 | LT ABS | 06 - | | ● |
| K | 1200 | R | 05 - | | ● |
| K | 1200 | RS | 02 - | | ● |
| K | 1200 | S | 05 - | | ● |
| R | 1200 | C | 98 - | | ● |
| R | 1200 | GS | 04 - | | ● |
| R | 1200 | R | 06 - | | ● |
| R | 1200 | R | 07 - | | ● |
| R | 1200 | RT | 05 - | | ● |
| R | 1200 | S | 05 - | | ● |
| R | 1200 | ST | 05 - | | ● |
| K | 1300 | GT | 09 - | | ● |
| K | 1300 | R | 09 - | | ● |
| K | 1300 | S | 09 - | | ● |

Street Sport Racing Enduro MX Off Road Racing ATV

MX10

2914

Dim./Size

→ 99,2 mm
 ↓ 39,7 mm
 H 7,5 mm

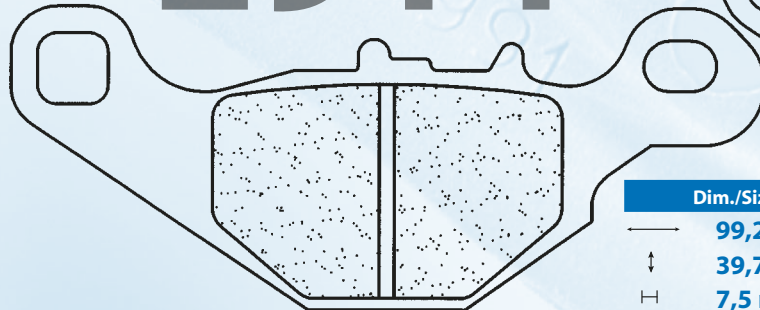
Dim./Size

→ 75,7 mm
 ↓ 40,6 mm
 H 8,2 mm

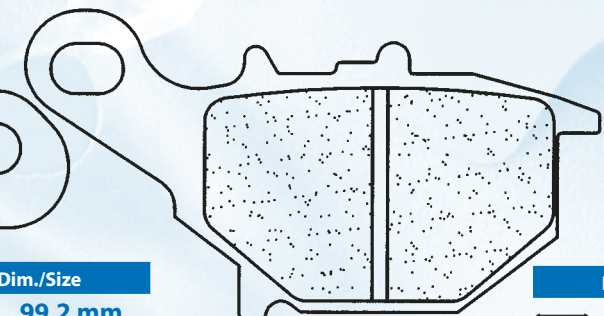
SUZUKI

| | | | | | |
|------|-----|----|---------|---|---|
| RM | 80 | T | 96 - 01 | 1 | ● |
| RM | 85 | /L | 02 - 04 | 1 | ● |
| DR-Z | 125 | L | 03 - 09 | 1 | ● |

Street Sport Racing Enduro MX Off Road Racing ATV

XBK5 C59

SPIEGLER

8 Piston Caliper - Road/Racing

1

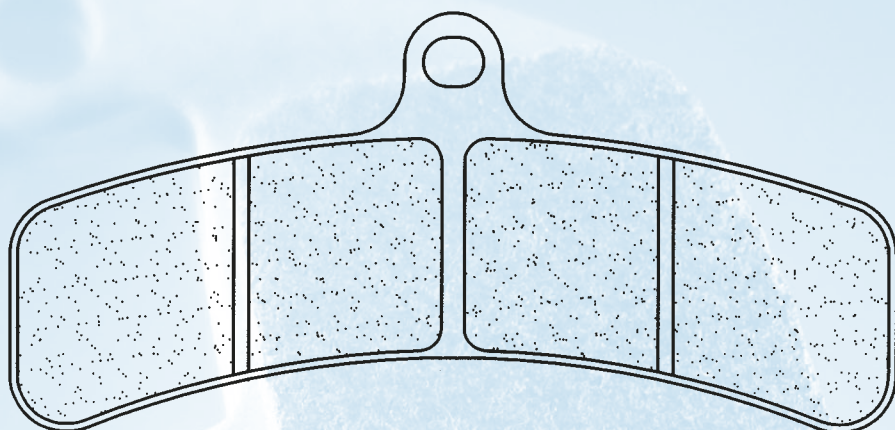

2919

Dim./Size

→ 117 mm
↑ 57,3 mm
H 8 mm

Street Sport Racing Enduro MX Off Road Racing ATV

XBK5 C59

SPIEGLER

4 Piston Caliper - Road/Racing

1

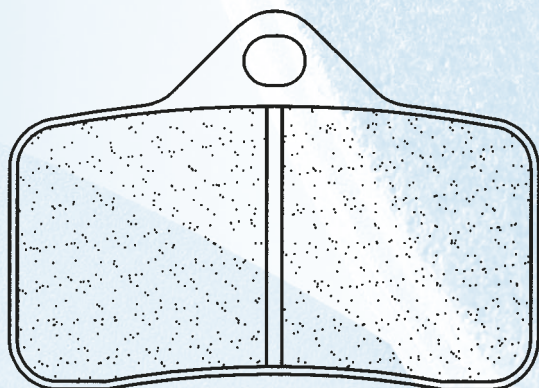

2920

Dim./Size

→ 69,5 mm
↑ 49,5 mm
H 8 mm

Street Sport Racing Enduro MX Off Road Racing ATV

RX3

AP RACING

CP 4226 Rear Caliper - Racing

1

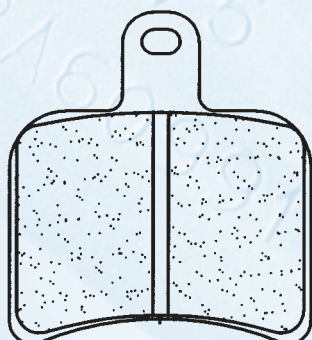

2922

Dim./Size

→ 39,6 mm
↑ 43,6 mm
H 7 mm

Street Sport Racing Enduro MX Off Road Racing ATV

X59 ATV1

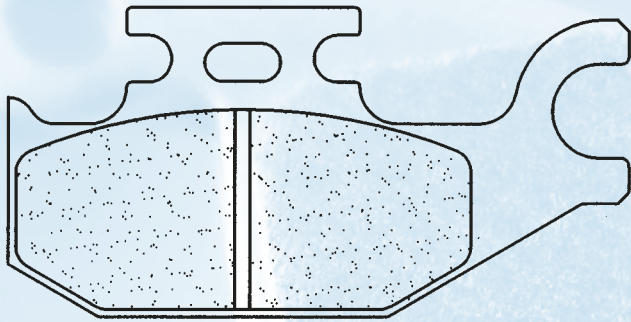

Dim./Size

82 mm
40,8 mm
9,5 mm

2923

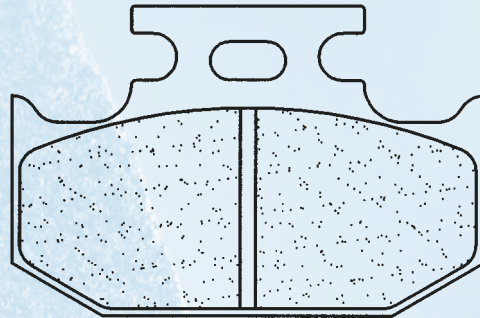

Dim./Size

62 mm
40,8 mm
9,5 mm

BOMBARDIER

| | | | | | | |
|-----|-----------------|----------|---|---|---|---|
| 200 | Rally 2x4 | 05 - | | | ● | ● |
| 330 | Outlander | 03 - L 1 | ● | ● | ● | ● |
| 400 | Outlander | 03 - L 1 | ● | ● | ● | ● |
| 400 | Outlander Max | 03 - L 1 | ● | ● | ● | ● |
| 500 | Quest | 02 - L 1 | ● | ● | ● | ● |
| 500 | Traxter 4x4 | 02 - L 1 | ● | ● | ● | ● |
| 500 | Traxter 4x4 Max | 02 - L 1 | ● | ● | ● | ● |
| 650 | DS | 01 - L 1 | ● | ● | ● | ● |
| 650 | Quest | 02 - L 1 | ● | ● | ● | ● |
| 650 | Quest Max | 02 - L 1 | ● | ● | ● | ● |
| 650 | Traxter Max | 03 - L 1 | ● | ● | ● | ● |
| 800 | Outlander | 06 - L 1 | ● | ● | ● | ● |
| 800 | Outlander XT | 06 - L 1 | ● | ● | ● | ● |

CAN-AM

| | | | | | | |
|-----|-------------------|----------|---|---|---|---|
| 400 | Outlander EFI | 09 - L 1 | ● | ● | ● | ● |
| 400 | Outlander Max STD | 07 - L 1 | ● | ● | ● | ● |
| 400 | Outlander STD | 07 - L 1 | ● | ● | ● | ● |
| 400 | Outlander MAX XT | 07 - L 1 | ● | ● | ● | ● |
| 400 | Outlander XT | 07 - L 1 | ● | ● | ● | ● |
| 500 | Outlander Max STD | 07 - L 1 | ● | ● | ● | ● |
| 500 | Outlander MAX XT | 07 - L 1 | ● | ● | ● | ● |
| 500 | Outlander STD | 07 - L 1 | ● | ● | ● | ● |
| 500 | Outlander XT | 07 - L 1 | ● | ● | ● | ● |
| 500 | Renegade | 08 - L 1 | ● | ● | ● | ● |
| 650 | Outlander Max STD | 07 - L 1 | ● | ● | ● | ● |
| 650 | Outlander MAX XT | 07 - L 1 | ● | ● | ● | ● |
| 650 | Outlander STD | 07 - L 1 | ● | ● | ● | ● |
| 650 | Outlander XT | 07 - L 1 | ● | ● | ● | ● |
| 800 | Outlander Max LTD | 07 - L 1 | ● | ● | ● | ● |
| 800 | Outlander Max STD | 07 - L 1 | ● | ● | ● | ● |
| 800 | Outlander MAX XT | 07 - L 1 | ● | ● | ● | ● |
| 800 | Outlander STD | 07 - L 1 | ● | ● | ● | ● |
| 800 | Outlander XT | 07 - L 1 | ● | ● | ● | ● |
| 800 | Renegade Efi | 07 - L 1 | ● | ● | ● | ● |
| 800 | Renegade | 08 - L 1 | ● | ● | ● | ● |
| 800 | Renegade X | 08 - L 1 | ● | ● | ● | ● |

CANNONDALE

| | | | | |
|-----|----------|----------|---|---|
| 440 | Blaze | 03 - L 1 | ● | ● |
| 440 | Cannibal | 03 - L 1 | ● | ● |
| 440 | Glamis | 03 - L 1 | ● | ● |
| 440 | Moto | 03 - L 1 | ● | ● |
| 440 | Speed | 03 - L 1 | ● | ● |

SUZUKI

| | | | | |
|-------|-----|-----------|-------------|---|
| KLT-A | 400 | King Quad | 08 - R 1 | ● |
| KLT-F | 400 | King Quad | 08 - R 1 | ● |
| LT-A | 400 | King Quad | 08 - R 1 | ● |
| LT-F | 400 | King Quad | 08 - R 1 | ● |
| LT-A | 450 | King Quad | 07 - R 1 | ● |
| LT-A | 500 | XPLO | 10 - L 1 | ● |
| LT-A | 700 | King Quad | 05 - 07 L 1 | ● |
| LT-A | 750 | King Quad | 08 - 09 L 1 | ● |
| LT-A | 750 | XPLO | 10 - L 1 | ● |

YAMAHA

| | | | | | |
|-----|-----|-------------------------|---------|---|---|
| YFM | 400 | FAM / FAN kodiak | 00 - 01 | 2 | ● |
| YFM | 400 | FAT/FAV (Big Bear) | 05 - 06 | 2 | ● |
| YFM | 400 | Grizzly FGW/FGX | 07 - 08 | 2 | ● |
| YFM | 450 | Kodiak FAR/FAS (5ND3/4) | 03 - 04 | 2 | ● |
| YFM | 450 | Kodiak FAT/FAHT/FAV | 05 - 06 | 2 | ● |
| YFM | 450 | Wolverine FXV-FXZ | 06 - | 2 | ● |

Street Sport Racing Enduro MX Off Road Racing ATV

X59 ATV1

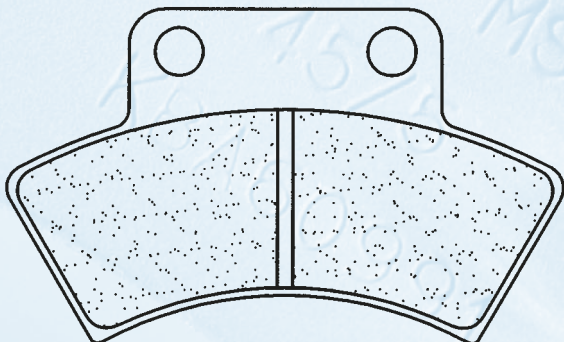

Dim./Size

72,7 mm
43,8 mm
7 mm

2924

POLARIS

| | | | |
|-----|------------------------|---------|---|
| | Trail Boss 2x4 / 4x4 | 88 - 89 | ● |
| 250 | 2x4 / 4x4 | 90 - 93 | ● |
| 250 | Big Boss 4x6 | 89 - 93 | ● |
| 250 | Trail Blazer | 90 - 98 | ● |
| 250 | Trail Boss | 91 - 99 | ● |
| 300 | 2x4 / 4x4 | 94 - 95 | ● |
| 300 | Big Boss 6x6 | 94 | ● |
| 300 | Xplorer 4x4 | 96 - 00 | ● |
| 300 | Xpress L | 96 - 97 | ● |
| 350 | Big Boss L | 93 | ● |
| 350 | L 2x4 / 4x4 | 90 | ● |
| 350 | L 4x4 | 93 | ● |
| 350 | Sportsman 4x4 | 93 | ● |
| 350 | Trail Boss L 2x4 / 4x4 | 91 - 93 | ● |
| 400 | Big Boss L | 94 - 97 | ● |
| 400 | L 2x4 | 94 - 95 | ● |
| 400 | L 4x4 | 94 | ● |
| 400 | Scrambler L 4x4 | 95 - 97 | ● |
| 400 | Sport L | 94 - 98 | ● |
| 400 | Sportsman L 4x4 | 94 - 97 | ● |
| 400 | Xplorer L 4x4 | 95 - 98 | ● |
| 400 | Xpress L | 96 - 97 | ● |
| 425 | Magnum 2x4 / 4x4 | 95 - 98 | ● |
| 425 | Magnum 6x6 | 96 - 97 | ● |
| 500 | Big Boss 6x6 | 98 - 99 | ● |
| 500 | Scrambler 4x4 | 97 | ● |
| 500 | Sportsman 4x4 | 96 - 97 | ● |
| 500 | Xplorer 4x4 | 97 | ● |

Street Sport Racing Enduro MX Off Road Racing ATV

2925

ATV1



Dim./Size

74,3 mm

52,9 mm

7 mm

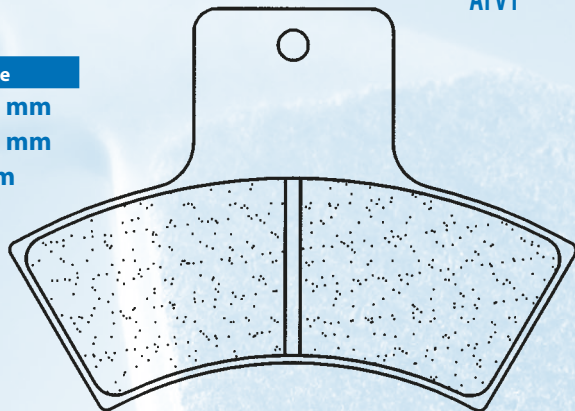

POLARIS

| | | | |
|-----|-----------------------|---------|---|
| 250 | Trail Blazer | 99 - 04 | ● |
| 250 | Xplorer 4x4 | 00 - | ● |
| 325 | Magnum 2x4 / 4x4 | 00 - 02 | ● |
| 325 | Trail Boss | 00 - 02 | ● |
| 325 | Xpedition | 00 - 01 | ● |
| 330 | Trail Boss | 03 - 04 | ● |
| 335 | Sportsman 4x4 | 99 - 00 | ● |
| 335 | Worker 4x4 | 99 - 00 | ● |
| 400 | Scrambler 2x4 / 4x4 | 00 - 02 | ● |
| 400 | Scrambler 4x4 | 98 - 00 | ● |
| 400 | Sportsman | 01 - 02 | ● |
| 400 | Xplorer L 2x4 / 4x4 | 99 - 02 | ● |
| 425 | Xpedition 4x4 | 00 - | ● |
| 455 | Diesel 4x4 EBS | 99 - 00 | ● |
| 455 | Diesel | 01 - | ● |
| 500 | Magnum 4x4 | 99 - 01 | ● |
| 500 | Scrambler 2x4 | 01 - 02 | ● |
| 500 | Scrambler 4x4 | 98 - 04 | ● |
| 500 | Sportsman 4x4 EBS/RSE | 98 - 02 | ● |

Street Sport Racing Enduro MX Off Road Racing ATV

ATV1



Dim./Size

67,3 mm

44,6 mm

7,8 mm

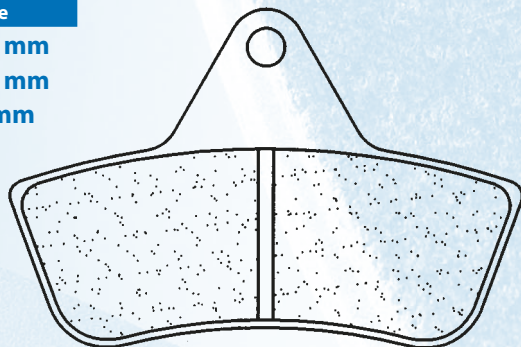

ARCTIC CAT

| | | | | |
|-----|--------------------------------|---------|---|---|
| 250 | 2X4 / 4x4 | 99 - 04 | 2 | ● |
| 300 | 2x4 / 4x4 | 98 - 04 | 2 | ● |
| 375 | 2x4 / 4x4 | 02 | 2 | ● |
| 400 | 2x4 / 4x4 | 98 - 04 | 2 | ● |
| 400 | 2x4/4x4 (FIS)(Man. Hand Brake) | 05 - | 2 | ● |
| 400 | TBX 4x4 | 04 | 2 | ● |
| 454 | Bear Cat 2x4 / 4x4 | 96 - 98 | 2 | ● |
| 454 | Arctic Cat 4x4 | 98 - | 2 | ● |
| 500 | 2x4 / 4x4 | 98 - 04 | 2 | ● |
| 500 | 2x4 / 4x4 (FIS) | 02 - 04 | 2 | ● |
| 500 | TBX 4x4 | 02 - 04 | 2 | ● |
| 500 | TRV 4x4 | 03 - 04 | 2 | ● |

LAVERDA

| | | | | |
|-----|----------------|------|---|---|
| 400 | Quasar 4x4 | 04 - | 2 | ● |
| 500 | Quasar 4x4 / C | 04 - | 2 | ● |

2926

Street Sport Racing Enduro MX Off Road Racing ATV

X59 ATV1

Dim./Size

96,9 mm

36,7 mm

7 mm

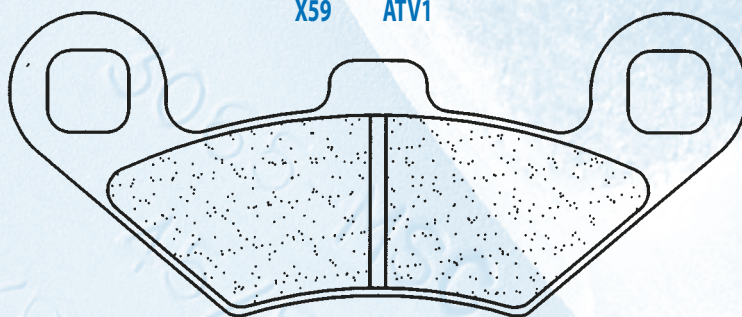

2927



CAN-AM

| | | | |
|----------------|----------------------|---------|-------|
| 450 | DS | 08 - | ● |
| POLARIS | | | |
| | Trail Boss 2x4 / 4x4 | 88 - 89 | 2 ● |
| 250 | 2x4 / 4x4 | 90 - 93 | 2 ● |
| 250 | Big Boss 4x6 | 89 - 93 | 2 ● |
| 250 | Trail Blazer | 90 - 98 | 2 ● |
| 250 | Trail Blazer | 99 - 04 | 2 ● |
| 250 | Trail Blazer | 05 - 06 | 2 ● |
| 250 | Trail Boss | 91 - 99 | 2 ● |
| 250 | Xplorer 4x4 | 00 - | 2 ● |
| 300 | 2x4 / 4x4 | 94 - 95 | 2 ● |
| 300 | Big Boss 6x6 | 94 | 2 ● |
| 300 | Sportsman 4x4 | 08 - | 2 ● ● |
| 300 | Xplorer 4x4 | 96 - 00 | 2 ● |
| 300 | Xpress L | 96 - 97 | 2 ● |
| 325 | Magnum 2x4 / 4x4 | 00 - 02 | 2 ● |
| 325 | Trail Boss | 00 - 02 | 2 ● |

POLARIS

| | | | | |
|-----|------------------------|---------|---|-----|
| 325 | Xpedition | 00 - 01 | 2 | ● |
| 325 | Xpedition | 02 - | 2 | ● |
| 330 | ATP 4x4 | 04 - 05 | 2 | ● ● |
| 330 | ATP | 06 - | 2 | ● |
| 330 | E Trail Blazer | 08 - | 2 | ● |
| 330 | Magnum 2X4 / 4X4 | 03 - 06 | 2 | ● |
| 330 | Trail Boss | 03 - 04 | 2 | ● |
| 330 | Trail Boss | 05 - 10 | 2 | ● |
| 335 | Sportsman 4x4 | 99 - 00 | 2 | ● |
| 335 | Worker 4x4 | 99 - 00 | 2 | ● |
| 350 | Big Boss L | 93 | 2 | ● |
| 350 | L 2x4 / 4x4 | 90 | 2 | ● |
| 350 | L 4x4 | 93 | 2 | ● |
| 350 | Sportsman 4x4 | 93 | 2 | ● |
| 350 | Trail Boss L 2x4 / 4x4 | 91 - 93 | 2 | ● |
| 400 | Big Boss L | 94 - 97 | 2 | ● |
| 400 | L 2x4 | 94 - 95 | 2 | ● |
| 400 | L 4x4 | 94 | 2 | ● |
| 400 | Scrambler 2x4 / 4x4 | 00 - 02 | 2 | ● |
| 400 | Scrambler 4x4 | 98 - 00 | 2 | ● |

POLARIS

| | | | | |
|-----|-----------------------|---------|---|---|
| 400 | Scrambler L 4x4 | 95 - 97 | 2 | ● |
| 400 | Sport L | 94 - 98 | 2 | ● |
| 400 | Sportsman | 01 - 02 | 2 | ● |
| 400 | Sportsman L 4x4 | 94 - 97 | 2 | ● |
| 400 | Xplorer L 4x4 | 95 - 98 | 2 | ● |
| 400 | Xplorer L 2x4 / 4x4 | 99 - 02 | 2 | ● |
| 400 | Xpress L | 96 - 97 | 2 | ● |
| 425 | Magnum 2x4 / 4x4 | 95 - 98 | 2 | ● |
| 425 | Magnum 6x6 | 96 - 97 | 2 | ● |
| 425 | Xpedition 4x4 | 00 - | 2 | ● |
| 450 | Outlaw S | 08 | | ● |
| 450 | Outlaw MXR | 09 - 10 | | ● |
| 450 | Sportsman | 06 - | 2 | ● |
| 455 | Diesel 4x4 EBS | 99 - 00 | 2 | ● |
| 455 | Diesel | 01 - | 2 | ● |
| 500 | ATP HO | 04 - 05 | 2 | ● |
| 500 | Big Boss 6x6 | 98 - 99 | 2 | ● |
| 500 | Magnum 4x4 | 99 - 01 | 2 | ● |
| 500 | Magnum 2X4 / 4x4 HDS | 02 - 03 | 2 | ● |
| 500 | Outlaw | 06 - 07 | 2 | ● |
| 500 | Predator | 03 - 05 | 2 | ● |
| 500 | Predator E | 06 - | 2 | ● |
| 500 | Ranger 6x6 | 00 - 02 | 2 | ● |
| 500 | Revolver | 06 - | 2 | ● |
| 500 | Scrambler 2x4 | 01 - 02 | 2 | ● |
| 500 | Scrambler 2x4 | 07 - 08 | 2 | ● |
| 500 | E Scrambler 2x4 / 4x4 | 08 - | 2 | ● |
| 500 | Scrambler 4x4 | 97 | 2 | ● |
| 500 | Scrambler 4x4 | 98 - 04 | 2 | ● |
| 500 | Scrambler 4x4 | 05 - 10 | 2 | ● |
| 500 | Sportsman 4x4 | 96 - 97 | 2 | ● |

2927 suite

POLARIS

| | | | | |
|-----|----------------------------|---------|---|---|
| 500 | Sportsman 4x4 EBS/RSE | 98 - 02 | 2 | ● |
| 500 | Sportsman 6x6 | 00 - 08 | 2 | ● |
| 500 | Sportsman Efi / HO | 03 - 08 | 2 | ● |
| 500 | Sportsman Touring | 08 - 10 | 2 | ● |
| 500 | Sportsman Efi Quad | 08 - 10 | 2 | ● |
| 500 | Sportsman X2 | 06 - 08 | 2 | ● |
| 500 | Sportsman X2 Efi | 07 - 09 | 2 | ● |
| 500 | Xplorer 4x4 | 97 | 2 | ● |
| 525 | Outlaw S | 08 - 10 | | ● |
| 525 | Outlaw IRS | 08 - 10 | | ● |
| 600 | Sportsman 4x4 | 03 - 05 | 2 | ● |
| 700 | Sportsman 4x4 | 02 - 06 | 2 | ● |
| 700 | Sportsman MV 700 | 05 - 06 | 2 | ● |
| 700 | Sportsman Efi | 07 - | 2 | ● |
| 700 | Sportsman X2 | 08 - | 2 | ● |
| 800 | RZR | 08 - | 2 | ● |
| 800 | Sportsman Efi | 05 - 07 | 2 | ● |
| 800 | Sportsman X2 Efi | 07 - 09 | 2 | ● |
| 800 | Sportsman Efi Int/HO | 07 - 10 | 2 | ● |
| 800 | Sportsman Touring / Efi | 08 - 09 | 2 | ● |
| 800 | Sportsman Efi 6x6 Big Boss | 09 - 10 | 2 | ● |

Street Sport Racing Enduro MX Off Road Racing ATV

C59
NISSIN

6 Piston Radial Caliper - Endurance

1

2931

Dim./Size

→ **100 mm**
 ↑ **44 mm**
 H **10 mm**

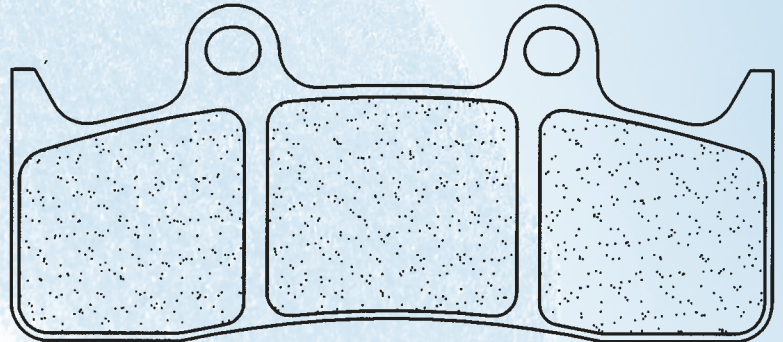

Street Sport Racing Enduro MX Off Road Racing ATV

C59
BREMBO

4 Piston Caliper - Racing

1

PVM

4 Piston Caliper - Racing

1

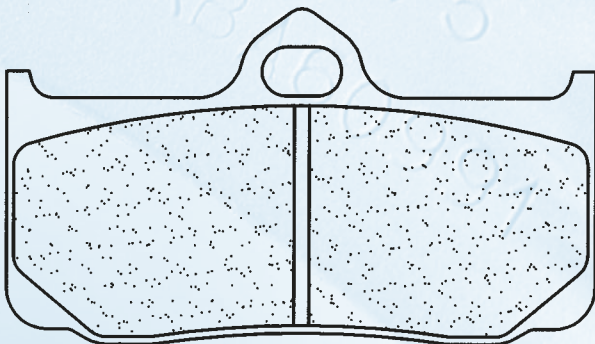

Dim./Size

→ **77,6 mm**
 ↑ **45,2 mm**
 H **10,5 mm**

2933

Street Sport Racing Enduro MX Off Road Racing ATV

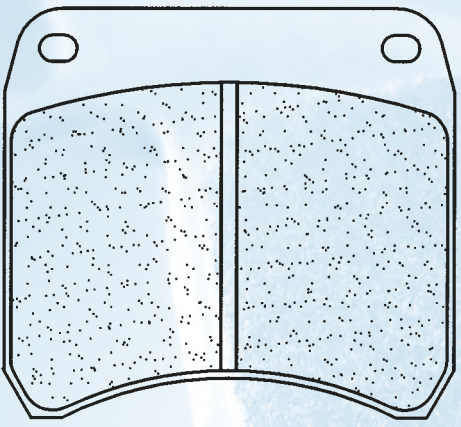
XBK5 C59



Dim./Size
 — 59,2 mm
 ↑↓ 57,4 mm
 H 10,3 mm

AP RACING CP 2868 Caliper - Road/Racing 1 ●

2950

Street Sport Racing Enduro MX Off Road Racing ATV

A3+ RX3

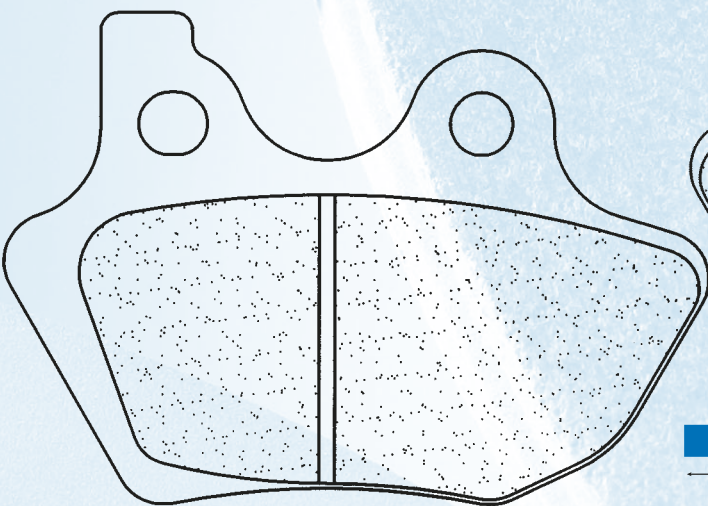

Dim./Size
 — 93,2 mm
 ↑↓ 65,1 mm
 H 7,5 mm

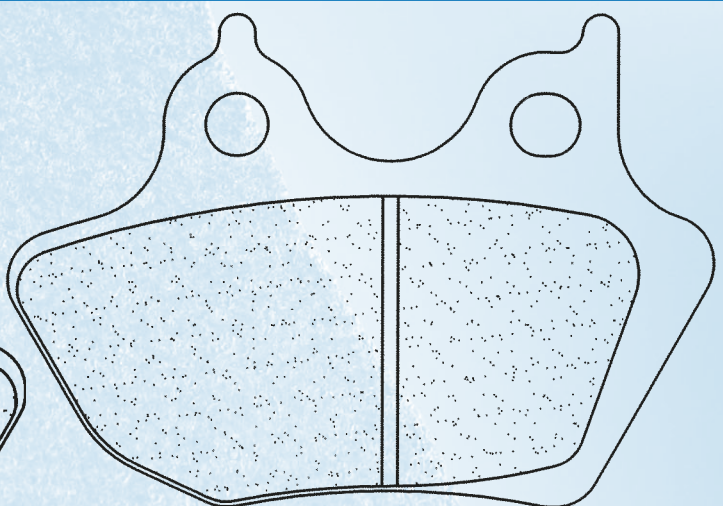

2958

HARLEY DAVIDSON

| | | | | | | |
|----------------|------|------------------------------|---------|---|---|---|
| XL | 883 | Sportster Custom | 00 - 03 | 1 | ● | ● |
| XL | 883 | Sportster R Roadster | 00 - 03 | 2 | ● | ● |
| XLH | 883 | Sportster | 00 - 03 | 1 | ● | ● |
| XLH | 883 | Sportster Hugger | 00 - 03 | 1 | ● | ● |
| XLH | 883 | Sportster R "Flat Track" | 00 - 03 | 1 | ● | ● |
| VRSCA | 1130 | V-Rod | 02 - 05 | 2 | ● | ● |
| VRSCB | 1130 | V-Rod | 04 - 05 | 2 | ● | ● |
| XL | 1200 | Sportster C Custom | 00 - 03 | 1 | ● | ● |
| XL | 1200 | Sportster Custom | 00 - 03 | 1 | ● | ● |
| XL | 1200 | Sportster S Sport | 00 - 03 | 1 | ● | ● |
| XLH | 1200 | Sportster | 00 - 03 | 1 | ● | ● |
| FLHR/FLHRI | 1450 | Road King | 00 - 04 | 2 | ● | ● |
| FLHRC/FLHRCI | 1450 | Road King Classic | 00 - 04 | 2 | ● | ● |
| FLHRS/FLHRSI | 1450 | Road King Custom | 04 - 06 | 2 | ● | ● |
| FLHT/FLHTI | 1450 | Electra Glide Standard | 00 - 06 | 2 | ● | ● |
| FLHTC/FLHTCI | 1450 | Electra Glide Classic | 00 - 06 | 2 | ● | ● |
| FLHTCUI | 1450 | Electra Glide Ultra Classic | 00 - 06 | 2 | ● | ● |
| FLHXI | 1450 | Street Glide | 06 - | 2 | ● | ● |
| FLSTC/FLSTCI | 1450 | Heritage Classic | 00 - 04 | 1 | ● | ● |
| FLSTC/FLSTCI | 1450 | Softail | 05 - 06 | 1 | ● | ● |
| FLSTF/FLSTFI | 1450 | Fat Boy | 00 - 06 | 1 | ● | ● |
| FLSTI | 1450 | Heritage Softail | 06 - | 1 | ● | ● |
| FLSTN/FLSTNI | 1450 | Softail Deluxe | 05 - 06 | 1 | ● | ● |
| FLSTS | 1450 | Heritage Springer | 00 - 03 | | ● | ● |
| FLSTSC/FLSTSCI | 1450 | Springer Classic | 05 - | | ● | ● |
| FLTR/FLTRI | 1450 | Road Glide Classic | 00 - 06 | 2 | ● | ● |
| FXD | 1450 | Dyna Super Glide | 00 - 03 | 1 | ● | ● |
| FXDBI | 1450 | Dyna Street Bob | 06 | 1 | ● | ● |
| FXDC/FXDCI | 1450 | Dyna Super Glide Custom | 05 - 06 | 1 | ● | ● |
| FXDI | 1450 | 35th Anniversary Super Glide | 06 - | 1 | ● | ● |
| FXDI | 1450 | Dyna Super Glide | 04 - 06 | 1 | ● | ● |
| FXDL | 1450 | Dyna Low Rider | 00 - 03 | 2 | ● | ● |
| FXDLI | 1450 | Dyna Low Rider | 04 - 06 | 1 | ● | ● |
| FXDS-CON | 1450 | Dyna Convertible | 00 - 02 | 2 | ● | ● |
| FXDWG | 1450 | Dyna Wide Glide | 00 - 03 | 2 | ● | ● |
| FXDWGI | 1450 | Dyna Wide Glide | 04 - 06 | 1 | ● | ● |
| FXDX | 1450 | Dyna Super Glide Sport | 00 - 03 | 2 | ● | ● |

HARLEY DAVIDSON

| | | | | | | |
|--------------|------|-----------------------------|---------|---|---|---|
| FXDXI | 1450 | Dyna Super Glide Sport | 04 - 06 | 2 | ● | ● |
| FXDXT | 1450 | Dyna Super Glide T-Sport | 00 - 03 | 2 | ● | ● |
| FXST/FXSTI | 1450 | Softail Standard | 00 - 04 | 1 | ● | ● |
| FXSTB/FXSTBI | 1450 | Night Train | 00 - 04 | 1 | ● | ● |
| FXSTBI | 1450 | Night Train | 06 - | 1 | ● | ● |
| FXSTD/FXSTDI | 1450 | Softail Deuce | 00 - 04 | 1 | ● | ● |
| FXSTDI | 1450 | Softail Deuce | 05 - 06 | 1 | ● | ● |
| FXSTI | 1450 | Softail Standard | 05 - 06 | 1 | ● | ● |
| FXSTS/FXSTSI | 1450 | Softail Springer | 00 - 04 | | ● | ● |
| FXSTS/FXSTSI | 1450 | Softail Springer | 05 - | | ● | ● |
| FXSTSI | 1450 | Softail | 06 - | 1 | ● | ● |
| FLHR | 1584 | Road King | 07 - | 2 | ● | ● |
| FLHRC | 1584 | Road King Classic | 07 - | 2 | ● | ● |
| FLHRS | 1584 | Road King Custom | 07 - | 2 | ● | ● |
| FLHT | 1584 | Electra Glide Standard | 07 - | 2 | ● | ● |
| FLHTC | 1584 | Electra Glide Classic | 07 - | 2 | ● | ● |
| FLHTCU | 1584 | Ultra Classic Electra Glide | 07 - | 2 | ● | ● |
| FLHX | 1584 | Street Glide | 07 - | 2 | ● | ● |
| FLSTC | 1584 | Heritage Softail Classic | 07 - | 1 | ● | ● |
| FLSTF | 1584 | Fat Boy | 07 - | 1 | ● | ● |
| FLSTFI | 1584 | Fat Boy | 07 - | 1 | ● | ● |
| FLSTN | 1584 | Softail Deluxe | 07 - | 1 | ● | ● |
| FLSTNI | 1584 | Softail Deluxe | 07 - | 1 | ● | ● |
| FLSTSCI | 1584 | Softail | 07 - | 1 | ● | ● |
| FXD | 1584 | Dyna Super Glide | 07 - | 1 | ● | ● |
| FXDB | 1584 | Dyna Street Bob | 07 - | 1 | ● | ● |
| FXDC | 1584 | Dyna Super Glide Custom | 07 - | 1 | ● | ● |
| FXDL | 1584 | Dyna Low Rider | 07 - | 1 | ● | ● |
| FXDWG | 1584 | Dyna Wide Glide | 07 - | 1 | ● | ● |
| FXST | 1584 | Softail Standard | 07 - | 1 | ● | ● |
| FXSTB | 1584 | Night Train | 07 - | 1 | ● | ● |
| FXSTC | 1584 | Softail Custom | 07 - | 1 | ● | ● |
| FXSTD | 1584 | Softail Deuce | 07 - | 1 | ● | ● |

Buyers Guide/Moto

1 - 2 = Nombre de jeux / Number of sets
 L = Gauche / Left - R = Droite / Right

Street Sport Racing Enduro MX Off Road Racing ATV

A3+

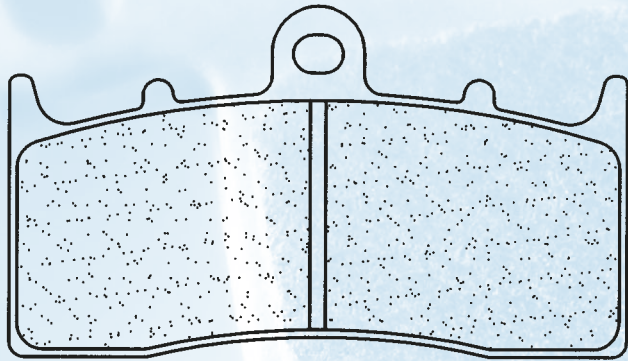

BMW

| | | | | | |
|---|------|------------------------|---------|---|---|
| R | 850 | R | 03 - | 2 | ● |
| R | 1100 | S ABS (Tokico Caliper) | 01 - | 2 | ● |
| R | 1150 | R | 01 - | 2 | ● |
| R | 1150 | R Rockster | 03 - | 2 | ● |
| R | 1150 | RS | 01 - | 2 | ● |
| K | 1200 | R Sport | 07 - | 2 | ● |
| K | 1200 | LT ABS | 01 - 05 | 2 | ● |
| K | 1200 | R | 05 - | 2 | ● |
| R | 1200 | CL | 03 - | 2 | ● |
| R | 1200 | R | 07 - | 2 | ● |
| K | 1300 | R | 09 - | 2 | ● |

Dim./Size

81,2 mm

46 mm

8,9 mm

2960

Street Sport Racing Enduro MX Off Road Racing ATV

A3+

SUZUKI

| | | | | | |
|----|-----|---------------|---------|---|---|
| RF | 900 | RR / RS / RS2 | 94 - 95 | 2 | ● |
| RF | 900 | RT / RV / RW | 96 - 99 | 2 | ● |

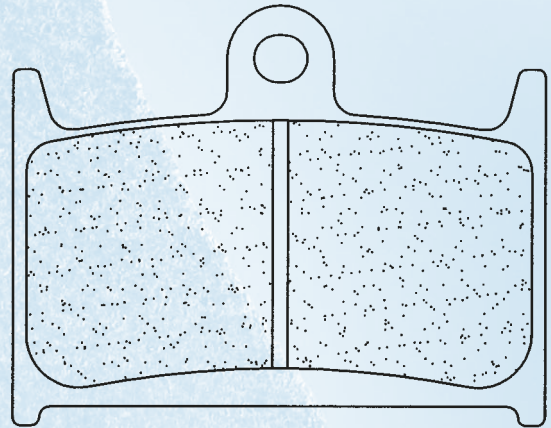

Dim./Size

69,8 mm

55,1 mm

7 mm

2961

Street Sport Racing Enduro MX Off Road Racing ATV

RX3

DUCATI

| | | | |
|-----|----|------|---|
| 999 | RS | 04 - | ● |
|-----|----|------|---|

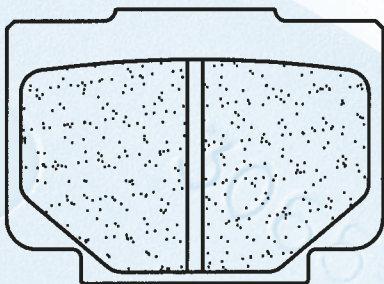

Dim./Size

49,7 mm

36 mm

8 mm

2984

Street Sport Racing Enduro MX Off Road Racing ATV

RX3

BMW

| | | | | |
|---|------|--------|---------|---|
| K | 1200 | LT | 99 - 00 | ● |
| K | 1200 | LT ABS | 01 - 05 | ● |
| R | 1200 | CL | 03 - | ● |

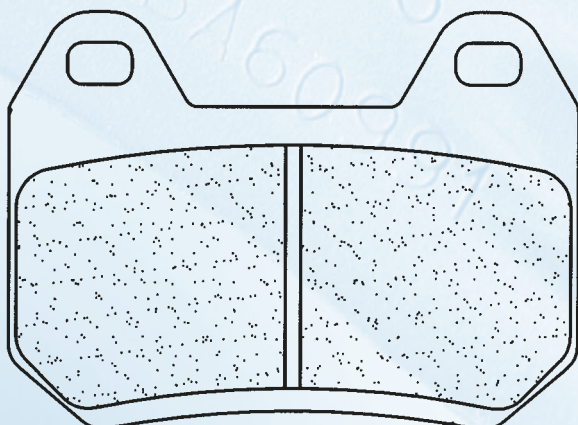

Dim./Size

75 mm

55,5 mm

8,5 mm

2987



Buyers guide

SCOOTER MAXI SCOOTER

Légende Legend

| | |
|---------|--------------|
| SCOOTER | MAXI-SCOOTER |
|---------|--------------|

Applications
Applications

SC MSC

Nuances disponibles
Available compounds

Année / Year
Avant / Front
Arrière / Rear

| APRILIA | | 97 | 1 | ● | ● |
|---------------|--------|----|---|---|---|
| 50 SR Stealth | | | | | |
| 125 Leonardo | | 96 | 1 | ● | |
| PIAGGIO | | | | | |
| 125 X9 | 04 - L | | 1 | ● | |
| 125 X9 | 04 - R | | 1 | ● | |

Gauche / Left
ou / or
Droit / Right

Nombre
de jeux
Number
of sets

3013

Référence
Reference

Dessin de
la plaquette -
Taille réelle
Pad drawing
- Real size

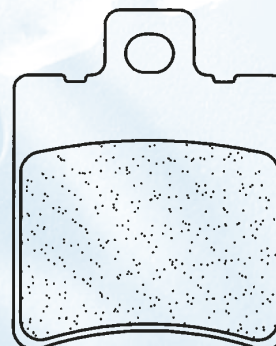

Dim./Size

| | | |
|---|----------------|-------------------------|
| → | 67,4 mm | ◀ Largeur / Width |
| ↑ | 49,6 mm | ◀ Hauteur / Height |
| H | 7 mm | ◀ Epaisseur / Thickness |

SCOOTER MAXI-SCOOTER

SC

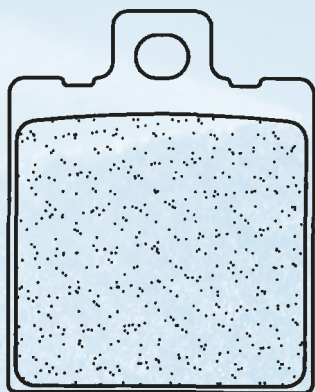

Dim./Size

→ 39,7 mm
↑ 50 mm
H 7 mm

APRILIA

| | | | | | |
|----|----|---------|---|---|---|
| 50 | RS | 93 - 95 | 1 | ● | ● |
| 50 | RS | 96 - 99 | 1 | ● | |

BETA

| | | | | | |
|----|------------|---------|---|---|--|
| 50 | Chrono 502 | 97 - | 1 | ● | |
| 50 | Quadra | 97 - | 1 | ● | |
| 50 | Tempo | 97 - 98 | 1 | ● | |

CAGIVA

| | | | | | |
|----|----------|------|---|---|--|
| 50 | Cucciolo | 97 - | 1 | ● | |
| 50 | Nuvola | 00 - | 1 | ● | |

3001

SCOOTER MAXI-SCOOTER

MSC

3003

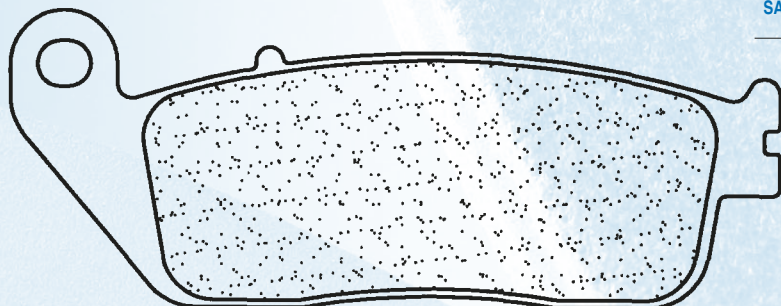

Dim./Size

→ 102 mm
↑ 40 mm
H 8,1 mm

HONDA

| | | | | | |
|----|--------------------|------|---|---|--|
| CN | 250 Helix (Fusion) | 93 - | 1 | ● | |
|----|--------------------|------|---|---|--|

KYMCO

| | | | | | |
|-----|----------------|---------|---|---|---|
| 125 | Downtown i | 10 - | 1 | ● | |
| 200 | Downtown i | 10 - | 1 | ● | |
| 250 | Xciting | 04 - 05 | 1 | ● | ● |
| 250 | Xciting | 06 - | 1 | ● | |
| 300 | Downtown i ABS | 10 - | 1 | ● | |
| 300 | People Gti | 10 - | 1 | ● | |
| 300 | Xciting Ri | 08 - | 2 | ● | |
| 500 | Xciting | 04 - | 2 | ● | ● |
| 500 | Xciting R ABS | 09 - | 2 | ● | ● |
| 700 | MyRoad | 09 - | 2 | ● | ● |

SACHS

| | | | | | |
|-----|--------------|----|---|---|--|
| 400 | Quattrocento | 08 | 2 | ● | |
|-----|--------------|----|---|---|--|

SCOOTER MAXI-SCOOTER

SC



Dim./Size

→ 31,6 mm
↑ 52 mm
H 5,5 mm

APRILIA

| | | | | | |
|------|--------------------|------|---|---|--|
| AF-1 | 50 AE | 86 - | 1 | ● | |
| AF-1 | 50 Europa / Futura | 90 - | 1 | ● | |
| | 50 Red Rose | 90 - | 1 | ● | |
| | 50 Tuareg | 86 - | 1 | ● | |
| | 50 Tuareg Rally | 90 - | 1 | ● | |

BENELLI

| | | | | | |
|----|--------|---------|---|---|--|
| 50 | Chrono | 92 - 93 | 1 | ● | |
|----|--------|---------|---|---|--|

FANTIC

| | | | | | |
|----|-------|------|---|---|--|
| 50 | Fast | | 1 | ● | |
| 50 | Oasis | 90 - | 1 | ● | |

KTM

| | | | | | |
|----|----|------|---|---|--|
| 50 | GO | 94 - | 1 | ● | |
|----|----|------|---|---|--|

MALAGUTI

| | | | | | |
|------|-----------------------------|---------|---|---|--|
| 50 | Centro | 93 - | 1 | ● | |
| F-12 | 50 Phantom (Liquid Cooled) | 94 - 98 | 1 | ● | |
| F-15 | 50 Fire Fox (Liquid Cooled) | 96 - 99 | 1 | ● | |

MBK

| | | | | | |
|----|---------|---------|---|---|--|
| 50 | X-Limit | 98 - 03 | 1 | ● | |
|----|---------|---------|---|---|--|

YAMAHA

| | | | | | |
|----|------|---------|---|---|--|
| DT | 50 R | 98 - 03 | 1 | ● | |
|----|------|---------|---|---|--|

3004

| HONDA | | | | | |
|---------|-----|-----------------------|---------|---|---|
| SRX | 50 | Shadow | 98 - | 1 | ● |
| | 75 | Yupy | 90 - | 1 | ● |
| SRX | 90 | Shadow | 98 - | 1 | ● |
| KYMCO | | | | | |
| | 50 | Cobra Cross | 01 - | 1 | ● |
| | 50 | Cobra Exclusive | 01 - | 1 | ● |
| | 50 | Cobra Racer | 01 - | 1 | ● |
| CX | 50 | Curio Super | 94 - | 1 | ● |
| | 50 | Easy | 01 - | 1 | ● |
| ZX | 50 | Fever | 96 - | 1 | ● |
| | 50 | Filly LX | 01 - | 1 | ● |
| | 50 | Heroism | 95 - 96 | 1 | ● |
| | 50 | Scout | 95 - | 1 | ● |
| DD | 50 | Sniper | 94 - | 1 | ● |
| | 50 | Super 9 | 00 - 01 | 1 | ● |
| ZX | 50 | Super Fever | 02 - | 1 | ● |
| | 50 | Top Boy On/Off Road | 96 - | 1 | ● |
| | 50 | Top Boy Racer / Cross | 01 - | 1 | ● |
| | 50 | Yup | 01 - | 1 | ● |
| K12 | 50 | | 95 - | 1 | ● |
| KB | 50 | | 95 - | 1 | ● |
| | 100 | Top Boy On/Off Road | 99 - | 1 | ● |
| KB | 100 | | 99 - | 1 | ● |
| | 150 | Freeway | 95 - | 1 | ● |
| PEUGEOT | | | | | |
| SV | 50 | Geo | 91 - | 1 | ● |
| SV | 50 | L | 93 - | 1 | ● |
| SV | 80 | Geo | 91 - | 1 | ● |
| SV | 100 | | 91 - | 1 | ● |
| SV | 125 | Geo | 91 - 92 | 1 | ● |
| SV | 125 | Geo / L Executive | 93 - | 1 | ● |
| SYM | | | | | |
| SR | 100 | Sunrise | 97 - | 1 | ● |

SCOOTER MAXI-SCOOTER
SC MSC

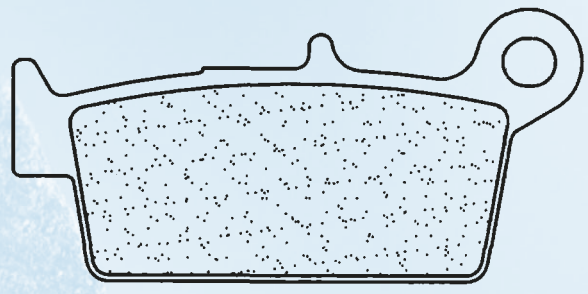

Dim./Size
→ 75 mm
↑ 36,1 mm
H 8,5 mm

3006

| MALAGUTI | | | | | |
|----------|-----|-------------|---------|---|---|
| | 125 | Centro ie | 08 - | | ● |
| | 160 | Centro ie | 08 - | | ● |
| MBK | | | | | |
| | 50 | X-Power | 98 - 03 | | ● |
| | 100 | Booster | 01 - | 1 | ● |
| | 125 | Flame R / F | 96 - 03 | 1 | ● |
| SACHS | | | | | |
| | 50 | Bee | 08 - 10 | 1 | ● |
| | 125 | Bee | 08 - 09 | 1 | ● |
| YAMAHA | | | | | |
| DT | 50 | R | 89 - 97 | 1 | ● |
| TZM | 50 | R | 94 - | | ● |
| TZR | 50 | | 90 - 92 | | ● |
| TZR | 50 | | 93 - 02 | | ● |
| XC | 125 | Cygnus | 96 - 03 | 1 | ● |
| XC | 150 | Fly One R | 98 - | 1 | ● |

SCOOTER MAXI-SCOOTER
SC MSC

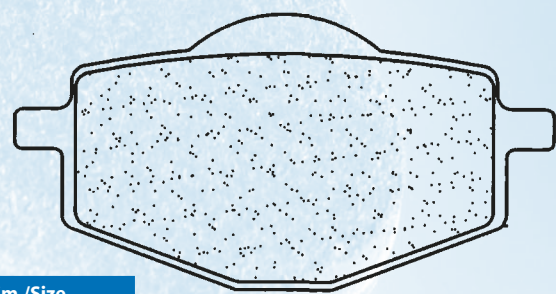

Dim./Size
→ 71 mm
↑ 36,2 mm
H 9 mm

3008

SCOOTER MAXI-SCOOTER
SC MSC

Dim./Size
→ 51,8 mm
↑ 36,6 mm
H 8 mm

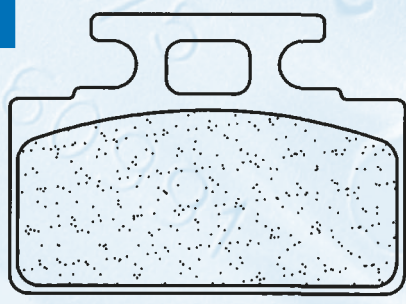

3009

| HONDA | | | | | |
|-------|-----|--------------|---------|---|---|
| NH | 50 | Lead | 86 - 93 | 1 | ● |
| NH | 80 | Lead Scooter | 86 - | 1 | ● |
| R | 80 | Lead | 88 - | 1 | ● |
| R | 125 | Lead | 88 - | 1 | ● |
| KYMCO | | | | | |
| | 50 | Manboy | 95 - | 1 | ● |
| | 50 | Zap | 95 - | 1 | ● |
| SP | 90 | Yup | 95 - | 1 | ● |
| SYM | | | | | |
| | 50 | Bullet | 93 | 1 | ● |
| | 50 | Cinderella | 99 - | 1 | ● |
| | 50 | Mio | 05 - | 1 | ● |
| DD | 50 | | 02 - | 1 | ● |
| | 100 | Cinderella | 01 - | 1 | ● |
| | 100 | Mio | 05 - | 1 | ● |
| | 110 | Bullet | 93 | 1 | ● |
| | 125 | Aero Wolf | | 1 | ● |

SCOOTER

MAXI-SCOOTER

HONDA

CN 250 Hélix



86 - 87

1



MSC

3011

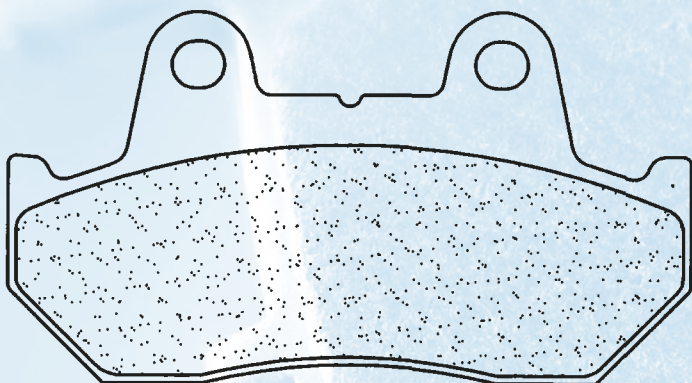

Dim./Size

→ 90 mm
↑ 49 mm
H 11 mm

SCOOTER

MAXI-SCOOTER

SC

3012

FANTIC

| | | | | | |
|----|-----------|------|--|--|---|
| 50 | Big Wheel | 94 - | | | ● |
| 50 | Grinta | 95 - | | | ● |
| 50 | Leader | 95 - | | | ● |

RIEJU

| | | | | | | |
|-----|----|--------------------------------------|---------|---|---|---|
| MRT | 50 | (Single Piston Caliper) | 09 - 10 | 1 | ● | ● |
| RS2 | 50 | FR | 09 - 10 | | | ● |
| | 50 | NKD | 08 - 10 | | | ● |
| MRT | 50 | Pro (Radial / Double Piston Caliper) | 09 - 10 | | | ● |

| | | | | | | |
|-----|----|------------------------------------------------|---------|---|---|---|
| MRT | 50 | Supermotard (Cast Wheel/Single Piston Caliper) | 09 - 10 | 1 | ● | ● |
|-----|----|------------------------------------------------|---------|---|---|---|

| | | | | | | |
|-----|----|-----------------------------------------|---------|--|--|---|
| MRT | 50 | Supermotard (Radial Caliper/Cast Wheel) | 09 - 10 | | | ● |
|-----|----|-----------------------------------------|---------|--|--|---|

| | | | | | | |
|--|----|--------------|---------|---|---|--|
| | 50 | Tango Motard | 09 - 10 | 1 | ● | |
|--|----|--------------|---------|---|---|--|

SHERCO

| | | | | | | |
|--|----|---------------------------------------|------|---|---|--|
| | 50 | SU (2T) Urban Base (Cast wheel model) | 10 - | 1 | ● | |
|--|----|---------------------------------------|------|---|---|--|

SUZUKI

| | | | | | | |
|----|----|------|------|---|---|--|
| TV | 50 | Wolf | 89 - | 1 | ● | |
|----|----|------|------|---|---|--|

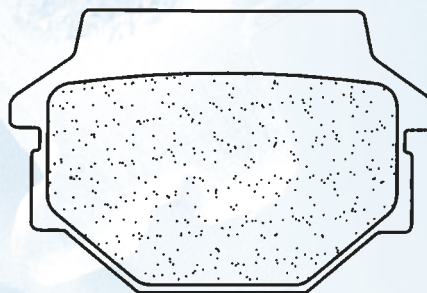
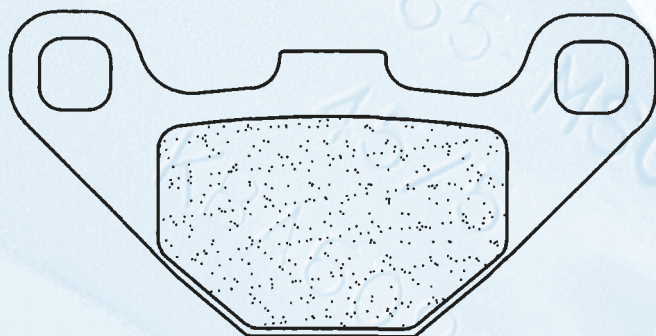

Dim./Size

→ 85 mm
↑ 42,5 mm
H 8 mm

Dim./Size

→ 56 mm
↑ 37,1 mm
H 10 mm

SCOOTER MAXI-SCOOTER

SC MSC

Dim./Size
→ 39,7 mm
↑ 49,5 mm
H 6 mm

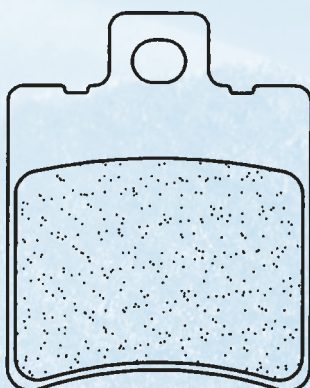

3013

APRILIA

| | | | | | |
|-----|----------------------------|---------|---|---|---|
| 50 | Amico All models | 92 - | 1 | ● | |
| 50 | Area 51 | 98 - | 1 | ● | ● |
| 50 | Business | 97 - | 1 | ● | |
| 50 | Classic | 96 - | 1 | ● | |
| 50 | Club | 97 - | 1 | ● | |
| 50 | Gulliver / Liquid | 95 - | 1 | ● | |
| 50 | Habana | 01 - | 1 | ● | |
| 50 | Mc Gulliver | 00 - | 1 | ● | |
| 50 | Mojito / Mojito Custom | 02 - | 1 | ● | |
| 50 | Netscaper | 97 - | 1 | ● | |
| 50 | Racing | 98 - | 1 | ● | ● |
| 50 | Rally | 95 - | 1 | ● | |
| 50 | Rally Liquid | 96 - | 1 | ● | |
| 50 | Scarabeo | 94 - 99 | 1 | ● | |
| 50 | Scarabeo Ditech | 02 - | 1 | ● | |
| 50 | Scarabeo Street | 00 - | 1 | ● | |
| 50 | Sonic | 99 - | 1 | ● | |
| 50 | SR / SR Liquid | 93 - | 1 | ● | |
| 50 | SR Ditech / Racing | 00 - | 1 | ● | |
| 50 | SR Replica (Liquid Cooled) | 96 - | 1 | ● | |
| 50 | SR Stealth | 97 - | 1 | ● | ● |
| 50 | SR Street | 05 - | 1 | ● | |
| 50 | SR Urban Kid | 93 - | 1 | ● | |
| 50 | SR Viper | 93 - | 1 | ● | |
| 50 | SR WWW | 97 - | 1 | ● | |
| 50 | Younger | 97 - | 1 | ● | |
| 125 | Leonardo | 97 - 98 | 1 | ● | ● |
| 125 | Leonardo | 96 | 1 | ● | |
| 150 | Leonardo | 97 - 98 | 1 | ● | ● |

ATALA

| | | | | | |
|------|--------------|------|---|---|--|
| 25 | Carosello | 97 - | 1 | ● | |
| AT10 | 50 Byte | 97 - | 1 | ● | |
| | 50 Carosello | 97 - | 1 | ● | |
| | 50 Hacker | 95 - | 1 | ● | |
| | 50 Skeggia | 98 - | 1 | ● | |
| 125 | Hacker | 98 - | 1 | ● | |

BENELLI

| | | | | | |
|-----|-------------------------|------|---|---|---|
| 50 | 491 | 98 - | 1 | ● | |
| 50 | 491 RR / Superbike | 99 - | 1 | ● | ● |
| 50 | 491 ST | 01 - | 1 | ● | |
| K2 | 50 Air / LC / Namur | 99 - | 1 | ● | ● |
| 50 | Chrono | 94 - | 1 | ● | |
| 50 | Naked | 02 - | 1 | ● | |
| 50 | Nemo / Quadra | 94 - | 1 | ● | |
| 50 | Pepe | 99 - | 1 | ● | |
| K2 | 100 Biposto | 99 - | 1 | ● | |
| 100 | Naked | 02 - | 1 | ● | |
| LX | 100 Pepe | 02 - | 1 | ● | |
| 125 | Adiva | 00 - | 1 | ● | |
| 125 | Velvet / Velvet Touring | 99 - | 1 | ● | ● |
| 150 | Adiva | 00 - | 1 | ● | |
| 150 | Velvet / Velvet Touing | 00 - | 1 | ● | ● |
| 250 | Velvet / Velvet Touring | 99 - | 1 | ● | ● |
| 400 | Velvet Dusk | 03 - | | ● | |

BETA

| | | | | | |
|-----|----------------|---------|---|---|---|
| 50 | Ark | 96 - | 1 | ● | ● |
| 50 | Ark LC Serie K | 98 - | 1 | ● | ● |
| 50 | Chrono 13 | 94 - | 1 | ● | |
| 50 | Eikon | 04 - | 1 | ● | |
| 50 | Quadra | 94 - 96 | 1 | ● | |
| 50 | RK-6 | 96 - | 1 | ● | ● |
| 50 | Tempo | 99 - | 1 | ● | |
| 125 | Eikon | 04 - | 1 | ● | |
| 150 | Eikon | 04 - | 1 | ● | |

CAGIVA

| | | | | | |
|-----|----------|------|---|---|--|
| 125 | Cucciolo | 00 - | 1 | ● | |
| 125 | Nuvola | 00 - | 1 | ● | |

CPI

| | | | | | |
|-----|-----------|------|--|--|---|
| 50 | GTR | 03 - | | | ● |
| 125 | GTR / GTS | 02 - | | | ● |
| 200 | GTR / GTS | 02 - | | | ● |

DERBI

| | | | | | |
|----|--------------------------|------|---|---|--|
| 50 | Vamos R (Brembo Caliper) | 95 - | 1 | ● | |
|----|--------------------------|------|---|---|--|

GARELLI

| | | | | | |
|-----|---------|------|---|---|---|
| 50 | Flo | 00 - | 1 | ● | |
| 125 | Panther | 02 - | | | ● |
| 150 | Panther | 02 - | | | ● |
| 250 | Panther | 02 - | | | ● |

GENERIC

| | | | | | |
|----|------------------------|------|--|--|---|
| 50 | Toxic | 07 - | | | ● |
| 50 | Trigger SM | 06 - | | | ● |
| 50 | Trigger SM Competition | 08 - | | | ● |
| 50 | Trigger X | 06 - | | | ● |
| 50 | Trigger X Competition | 08 - | | | ● |

GILERA

| | | | | | |
|-----|----------------|---------|---|---|---|
| 50 | Eaglet | 97 - | 1 | ● | |
| 50 | Ice | 02 - | 1 | ● | |
| 50 | Runner | 98 - 05 | 1 | ● | |
| 50 | Runner | 97 | 1 | ● | |
| 50 | Runner SP | 01 - 05 | 1 | ● | |
| 50 | Stalker | 97 - | 1 | ● | |
| 50 | Storm | 94 - | 1 | ● | |
| 50 | Typhoon | 93 - 95 | 1 | ● | |
| NRG | 50 | 94 - | 1 | ● | |
| 70 | Runner Malossi | 98 - | 1 | ● | ● |
| 80 | Typhoon | 95 - | 1 | ● | |
| 175 | Mad Mud | 02 - | | | ● |
| 200 | Stalker | 97 - | 1 | ● | |

HERCULES

| | | | | | |
|----|---------------------------|------|---|---|--|
| 50 | Gipsy / Splinter / Reggae | 95 - | 1 | ● | |
|----|---------------------------|------|---|---|--|

HONDA

| | | | | | |
|-----|-----------------------|---------|---|---|--|
| 50 | Formula | 94 - | 1 | ● | |
| SGX | 50 Sky | 97 - 03 | 1 | ● | |
| 50 | Sky Classic | 00 - | 1 | ● | |
| 50 | Sky Vetro | 00 - | 1 | ● | |
| SFX | 50 Sport | 95 - 04 | 1 | ● | |
| SH | 50 T / Fifty / Scoopy | 97 - 03 | 1 | ● | |
| SZX | 50 X8R-S / X8R-X | 98 - | 1 | ● | |
| SXR | 50 | 98 - | 1 | ● | |

HYOSUNG

| | | | | | |
|-----|------------|------|---|---|--|
| 125 | Boomer | 03 - | 1 | ● | |
| GPS | 125 D | 00 - | 1 | ● | |
| 125 | Exceed | 02 - | 1 | ● | |
| 125 | Grand Prix | 98 - | 1 | ● | |
| 125 | Hyper | 99 - | 1 | ● | |
| 150 | Exceed | 02 - | 1 | ● | |
| 150 | Grand Prix | 98 - | 1 | ● | |

ITALJET

| | | | | | |
|----|---------|------|---|---|---|
| 50 | Formula | 94 - | 1 | ● | ● |
| 80 | Formula | 94 - | 1 | ● | ● |

KEEWAY

| | | | | | |
|-----|-----|------|---|---|--|
| 125 | Arn | 06 - | 1 | ● | |
| 150 | Arn | 06 - | 1 | ● | |

KTM

| | | | | | |
|----|--------------------------|---------|---|---|--|
| 50 | Comet PL / TS / RLW / RS | 86 - 91 | 1 | ● | |
|----|--------------------------|---------|---|---|--|

MACAL

| | | | | | |
|----|-------|------|---|---|--|
| 50 | Flash | 99 - | 1 | ● | |
|----|-------|------|---|---|--|

MALAGUTI

| | | | | | |
|------|--------------------------------|---------|---|---|---|
| 50 | Centro SL | 98 - | 1 | ● | |
| 50 | Ciak | 00 - | 1 | ● | |
| 50 | Ciak Twin Disk | 02 - | 1 | ● | ● |
| EL | 50 Crosser | 97 - | 1 | ● | |
| F-15 | 50 Fire Fox | 01 - | 1 | ● | |
| F-15 | 50 Fire Fox LC | 01 - | 1 | ● | ● |
| F-10 | 50 Jet-Line | 94 - | 1 | ● | |
| F-15 | 50 Mechatronic | 03 - | 1 | ● | ● |
| F-12 | 50 Phantom (Air cooled) | 99 - | 1 | ● | |
| F-12 | 50 Phantom (Liquid Cooled) | 99 - | 1 | ● | ● |
| F-12 | 50 Phantom Digit | 02 - | 1 | ● | ● |
| F-12 | 50 Racing Life LC / Tyre Track | 03 - | 1 | ● | ● |
| F-10 | 50 Timemachine | 03 - | 1 | ● | |
| F-10 | 50 WAP | 02 - | 1 | ● | |
| 50 | Yesterday | 97 - | 1 | ● | |
| 100 | Ciak | 00 - | 1 | ● | ● |
| F-12 | 100 Phantom | 00 - | 1 | ● | |
| F-12 | 100 Phantom Twin Disk | 02 - | 1 | ● | ● |
| 125 | Ciak / Ciak Master | 01 - 08 | 1 | ● | |

3013 suite

| MALAGUTI | | | | |
|----------|----------------------------------|---------|---|---|
| 125 | F-18 | 00 - | 1 | ● |
| 150 | Ciak / Ciak Master | 01 - 08 | 1 | ● |
| 150 | F-18 | 00 - | 1 | ● |
| | Ciak (Electric Power) | 00 - 05 | 1 | ● |
| MBK | | | | |
| 50 | Booster 12 " | 03 - | 1 | ● |
| 50 | Booster Naked | 04 - | 1 | ● |
| 50 | Booster NG | 95 - | 1 | ● |
| 50 | Booster Road | 94 - 95 | 1 | ● |
| 50 | Booster Rocket | 96 - | 1 | ● |
| 50 | Booster Spirit | 96 - | 1 | ● |
| 50 | Booster Track | 96 - | 1 | ● |
| 50 | Equalis | 95 - | 1 | ● |
| 50 | Evolis | 92 - | 1 | ● |
| 50 | Fizz | 94 - | 1 | ● |
| 50 | Flipper | 98 - | 1 | ● |
| MBK | | | | |
| 50 | Forte | 94 - 95 | 1 | ● |
| 50 | Mach G | 03 - | 1 | ● |
| 50 | Nitro | 97 - | 1 | ● |
| 50 | Ovetto | 97 - | 1 | ● |
| 50 | Ovetto (4T) | 09 - | 1 | ● |
| 80 | Evolis | 94 - | 1 | ● |
| 100 | Nitro | 01 - | 1 | ● |
| 100 | Ovetto | 01 - | 1 | ● |
| 125 | Doodo | 00 - 05 | 1 | ● |
| 150 | Doodo | 00 - 05 | 1 | ● |
| MOTRON | | | | |
| 50 | Spike | 97 - | 1 | ● |
| 50 | Sting | 95 - | 1 | ● |
| 50 | Synco | 97 - | 1 | ● |
| 50 | Thunder | 95 - | 1 | ● |
| PEUGEOT | | | | |
| 50 | Buxy (Brembo Caliper) | 94 - 97 | 1 | ● |
| 50 | Speedake (Brembo Caliper) | 94 - 97 | 1 | ● |
| 50 | Speedflight LC (Brembo Caliper) | 96 - 00 | 1 | ● |
| 50 | Zenith (Grimeca Caliper) | 96 - | 1 | ● |
| 50 | Zenith Luxe | 94 - | 1 | ● |
| 100 | Speedflight LCA (Brembo Caliper) | 97 - | 1 | ● |
| 125 | Tweet | 10 - | | ● |
| 150 | Tweet | 10 - | | ● |
| PGO | | | | |
| 50 | G-max Doppler | 06 - | 1 | ● |
| 50 | Rodoshow | 01 - | 1 | ● |
| 90 | Rodoshow | 02 - | 1 | ● |
| PIAGGIO | | | | |
| NRG | 50 Extreme | 01 - | 1 | ● |
| 50 | Free | 97 - | 1 | ● |
| NRG | 50 MC 2 | 98 - 02 | 1 | ● |
| NRG | 50 MC 2 | 96 - 97 | 1 | ● |
| NRG | 50 MC 3 DD / DT | 02 - | 1 | ● |
| 50 | NTT | 95 | 1 | ● |
| NRG | 50 Power DD | 05 | 1 | ● |
| NRG | 50 Power DD | 06 - | | ● |
| NRG | 50 Purejet | 05 | 1 | ● |
| NRG | 50 Purejet | 06 - | | ● |
| NRG | 50 Silver Bullet | 10 | | ● |
| 50 | Storm | 94 - 95 | 1 | ● |
| 50 | Typhoon | 93 - 95 | 1 | ● |
| 50 | Typhoon Catalysed | 02 - | 1 | ● |

| PIAGGIO | | | | |
|----------|---------------------------------------|---------|---|---|
| 50 | Zip & Zip | 94 - | 1 | ● |
| 50 | Zip Fast Rider | 93 - 95 | 1 | ● |
| LXV | 50 | 08 - | 1 | ● |
| NRG.1 | 50 | 94 - 95 | 1 | ● |
| NRG | 50 | 96 - 00 | 1 | ● |
| TPH | 50 | 93 - 95 | 1 | ● |
| | 100 Free | 02 - | 1 | ● |
| 125 | Hexagon | 94 - 95 | 1 | ● |
| PIAGGIO | | | | |
| 125 | Typhoon Catalysed | 02 - | 1 | ● |
| LXV | 125 | 08 - | 1 | ● |
| SKR | 125 | 94 - | 1 | ● |
| 150 | Hexagon | 94 - 95 | 1 | ● |
| LX | 150 | 08 - | 1 | ● |
| SHE-LUNG | | | | |
| 50 | Racer | 96 - | 1 | ● |
| SIAM | | | | |
| 50 | Falcon | 97 - | 1 | ● |
| 50 | Scross | 97 - | 1 | ● |
| SIMSON | | | | |
| 50 | Habict CX | 01 - | 1 | ● |
| 50 | Spatz | 99 - | 1 | ● |
| 50 | Sperber | 99 - | 1 | ● |
| 50 | Star | 99 - | 1 | ● |
| 125 | Schikra | 99 - | | ● |
| SUZUKI | | | | |
| AP | 50 R / S / T / V / W | 96 - 02 | 1 | ● |
| AY | 50 V/W/V/W/W/RW/K1-K4 Katana | 97 - 04 | 1 | ● |
| UX | 50 W Zillion | 99 - 02 | 1 | ● |
| AY | 50 WRK2-WRK4 Katana (Grimeca Caliper) | 99 - 04 | 1 | ● |
| YAMAHA | | | | |
| YQ | 50 Aerox / Aerox R | 97 - | 1 | ● |
| YM | 50 Breeze | 94 - 95 | 1 | ● |
| BW'S | 50 Bump | 97 - | 1 | ● |
| CS | 50 JOG-R | 02 - 05 | 1 | ● |
| CS | 50 JOG-R | 06 - 09 | 1 | ● |
| YN | 50 Neo's (2T) | 97 - 09 | 1 | ● |
| YN | 50 Neo's (4T) | 09 - | 1 | ● |
| BW'S | 50 Next Generation | 99 - 07 | 1 | ● |
| BW'S | 50 Original | 96 - | 1 | ● |
| BW'S | 50 R | 94 - 95 | 1 | ● |
| YA | 50 R Axis | 95 - 96 | 1 | ● |
| BW'S | 50 Spy | 95 - | 1 | ● |
| YH | 50 Why | 98 - 09 | 1 | ● |
| CS | 50 Z (JOG-RR) | 03 - 05 | 1 | ● |
| CS | 50 Z (JOG-RR) | 06 - 10 | 1 | ● |
| YE | 50 Zest | 92 - 95 | 1 | ● |
| YE | 80 Zest | 93 - | 1 | ● |
| YQ | 100 Aerox | 00 - 04 | 1 | ● |
| YN | 100 Neo's | 99 - 03 | 1 | ● |
| XN | 125 Teos | 00 - 03 | 1 | ● |
| XN | 150 Teos | 02 - | 1 | ● |

SCOOTER MAXI-SCOOTER

SC MSC

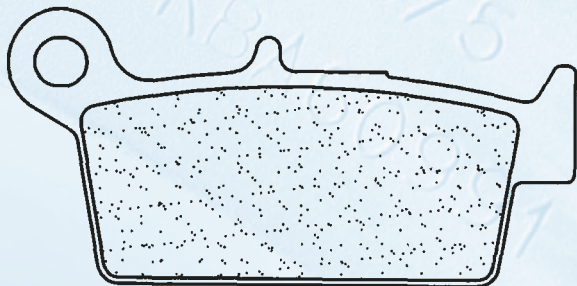

Dim./Size
 ← 75 mm
 ↑ 36,1 mm
 H 9,5 mm

| DAELIM | | | | |
|---------|-------------|---------|---|---|
| 50 | Besbi | 07 - | 1 | ● |
| HONDA | | | | |
| NH | 50 Lead | 94 - | 1 | ● |
| NH | 90 Yupy | 90 - 94 | 1 | ● |
| ITALJET | | | | |
| 125 | Amarcord | 08 - | 1 | ● |
| KYMCO | | | | |
| 50 | Cobra Cross | 99 - 00 | 1 | ● |
| 50 | Cobra Racer | 99 - 00 | 1 | ● |
| 50 | ZX12 | 06 - | 1 | ● |
| 90 | Man Boy | 96 - | 1 | ● |
| 125 | Super 9 | 00 - | 1 | ● |
| 250 | Super 9 | 00 - | 1 | ● |

3014

SCOOTER MAXI-SCOOTER

SC MSC

3015

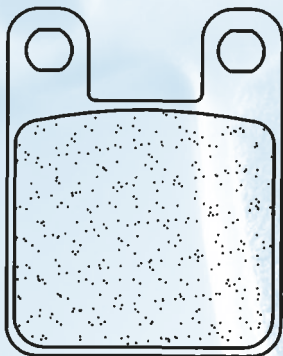

Dim./Size

36 mm

45,5 mm

6 mm

APRILIA

| | | | | |
|----|----|------|--|---|
| 50 | RS | 06 - | | ● |
| 50 | RX | 06 - | | ● |

BARIGO

| | | | | |
|--|------------------|------|---|---|
| | Scooter Electric | 97 - | 1 | ● |
|--|------------------|------|---|---|

BETA

| | | | | |
|-----|-------------|---------|---|---|
| 50 | Eikon | 99 - 03 | 1 | ● |
| RR | Enduro | 99 - | | ● |
| RR | Enduro Alu | 04 - 07 | | ● |
| RR | Motard Alu | 04 - | | ● |
| RR | Pro Race | 98 - | | ● |
| RR | Standard | 99 - | | ● |
| RR | Supermotard | 04 - 07 | 1 | ● |
| RR | Supermotard | 99 - 03 | | ● |
| 50 | Techno | 96 - | 1 | ● |
| 50 | Tempo | 92 - 96 | 1 | ● |
| 125 | Eikon | 99 - 03 | 1 | ● |
| 150 | Eikon | 99 - 03 | 1 | ● |
| 250 | Eikon | 99 - | 1 | ● |

BUTALCO

| | | | | |
|----|--------|------|--|---|
| 50 | Astro | 01 - | | ● |
| 50 | Lobito | 99 - | | ● |

CAGIVA

| | | | | |
|----|----------|------|---|---|
| 50 | Corsa | 98 - | 1 | ● |
| 50 | Mantis | 99 - | 1 | ● |
| 50 | Progress | 98 - | 1 | ● |

DERBI

| | | | | |
|-----|-----------------------|---------|---|---|
| 50 | Aceno | 98 - | 1 | ● |
| 50 | Atlantis | 99 - | 1 | ● |
| 50 | Atlantis 4T / Bullet | 04 - | 1 | ● |
| 50 | Atlantis H2O / Wave | 01 - | 1 | ● |
| 50 | Aventura | 95 - | 1 | ● |
| 50 | Black Devil | 04 - | | ● |
| 50 | DRD Pro Corse | 06 - | | ● |
| 50 | Easy | 96 - | 1 | ● |
| 50 | Fenix | 94 - | 1 | ● |
| 50 | Furax | 95 - | 1 | ● |
| 50 | Hunter | 97 - | 1 | ● |
| 50 | Manhattan | 99 - | 1 | ● |
| GPR | Nude | 05 - | | ● |
| 50 | Paddock | 96 - | 1 | ● |
| 50 | Predator LC | 98 - | 1 | ● |
| 50 | Predator O2 | 00 - | 1 | ● |
| GPR | R | 98 - 04 | | ● |
| 50 | R DRD | 05 - | | ● |
| 50 | R Racer | 05 - | 1 | ● |
| 50 | R X-Treme | 05 - | 1 | ● |
| GPR | Racing | 05 - | | ● |
| 50 | Rambla | 06 - | 1 | ● |
| 50 | Savanah | 91 - | 1 | ● |
| 50 | Senda L | 99 - | 1 | ● |
| 50 | Senda R / X-Treme | 94 - 04 | 1 | ● |
| 50 | Senda R DRD | 03 - 04 | | ● |
| 50 | Senda SM / X-Treme | 99 - 04 | 1 | ● |
| 50 | Senda SM DRD | 03 - 04 | 1 | ● |
| 50 | Senda SM DRD Black Ed | 03 - | | ● |
| 50 | SM DRD / Racer | 05 - | | ● |
| 50 | SM X-Treme / X-Race | 05 - | | ● |
| 50 | Stinger | 96 - | 1 | ● |
| 50 | Urban | 94 - | 1 | ● |
| 50 | Vamos R / L / FL | 95 - | 1 | ● |
| 50 | Variant Sport R | 01 - | 1 | ● |
| DS | | 88 | 1 | ● |
| FDX | | 89 | 1 | ● |
| GP | | 01 - | 1 | ● |
| GP1 | | 01 - 04 | 1 | ● |
| GP1 | | 05 - | | ● |
| 100 | Atlantis 4T | 04 - | 1 | ● |

DERBI

| | | | | |
|-----|-------------------|------|---|---|
| 100 | Atlantis O2 / H2O | 01 - | 1 | ● |
| 125 | Atmosphere | 99 - | 1 | ● |
| 125 | Boulevard | 04 - | 1 | ● |
| 125 | GP1 | 05 - | | ● |
| 125 | Predator | 99 - | 1 | ● |
| 150 | Boulevard | 04 - | 1 | ● |

FACTORY

| | | | | | |
|----|----|--------|------|--|---|
| SM | 50 | Chrono | 04 - | | ● |
| SP | 50 | Chrono | 04 - | | ● |
| RP | 50 | Desert | 04 - | | ● |
| YR | 50 | Desert | 04 - | | ● |

GILERA

| | | | | | |
|-----|--------|-------------|------|---|---|
| 50 | H@k | 99 - | 1 | ● | |
| GSM | 50 | Supermotard | 01 - | 1 | ● |
| 50 | Zulu | 01 - | 1 | ● | |
| RCR | 50 | | 04 - | 1 | ● |
| SMT | 50 | | 04 - | 1 | ● |
| 125 | Surfer | 01 - | 1 | ● | |
| SC | 125 | | 06 - | | ● |

HERO ENVOY

| | | | | |
|----|--|------|---|---|
| 50 | | 99 - | 1 | ● |
|----|--|------|---|---|

HRD

| | | | | |
|----|---------------------|---------|--|---|
| 50 | Sonic 2 Supermotard | 00 - 02 | | ● |
| 50 | Sonic 2 Trail | 00 - 02 | | ● |

HUSQVARNA

| | | | | |
|----|----|------|--|---|
| 50 | SM | 02 - | | ● |
| 50 | WR | 02 - | | ● |

ITALJET

| | | | | |
|-----|----------------|---------|---|---|
| 50 | Dragster | 99 - | 1 | ● |
| 50 | Formula Air | 99 - | 1 | ● |
| 50 | Formula LC | 98 - | 1 | ● |
| 50 | Formula Race | 95 - | 1 | ● |
| 50 | Torpedo | 97 - | 1 | ● |
| 50 | Torpedo 4T | 01 - | 1 | ● |
| 50 | Velocifero | 94 - | 1 | ● |
| 125 | Dragster | 97 - | 1 | ● |
| 125 | Formula | 96 - | 1 | ● |
| 125 | Formula LC | 99 - | 1 | ● |
| 125 | Torpedo 4T Pro | 99 - 09 | 1 | ● |
| 125 | Twin | 99 - | 1 | ● |
| 150 | Torpedo 4T Pro | 00 - | 1 | ● |
| 180 | Dragster | 99 - | 1 | ● |

MACAL

| | | | | |
|----|------------|------|---|---|
| 50 | Trophy | 99 - | 1 | ● |
| 50 | Trophy H2O | 99 - | 1 | ● |

MALAGUTI

| | | | | | |
|-----|-------|--------|------|---|---|
| XSM | 50 | | 04 - | | ● |
| NKD | 50 | Drakon | 06 - | | ● |
| 50 | Fifty | 04 - | | ● | |

XTM

| | | | | |
|----|--|------|---|---|
| 50 | | 04 - | 1 | ● |
|----|--|------|---|---|

MBK

| | | | | |
|----|---------|------|---|---|
| 50 | X-Limit | 04 - | 1 | ● |
| 50 | X-Power | 04 - | | ● |

MH (MOTORHISPANIA)

| | | | | | |
|-----|----|-------------|------|---|---|
| RYZ | 50 | Enduro | 05 - | 1 | ● |
| MH | 50 | Furia 6v | 99 - | 1 | ● |
| MH | 50 | Furia Max | 06 - | 1 | ● |
| RX | 50 | Racing | 00 - | | ● |
| RYZ | 50 | Supermotard | 05 - | | ● |
| MH | 50 | Urban Bike | 06 - | | ● |

PEUGEOT

| | | | | | |
|-------|---------------------------------|-----------------------|---------|---|---|
| 50 | Buxy (AJP Caliper) | 94 - | 1 | ● | |
| 50 | Elyséo | 02 - | 1 | ● | |
| 50 | Elyséo (AJP Caliper) | 98 - 01 | 1 | ● | |
| 50 | Elystar | 02 - 07 | 1 | ● | |
| 50 | Elystar Advantage | 02 - 07 | 1 | ● | |
| XP6 | 50 | Enduro | 03 - 10 | 1 | ● |
| 50 | Jet C-Tech | 09 - | 1 | ● | |
| 50 | Jet Force | 03 - | 1 | ● | |
| 50 | Jet Force H2I | 11 - | 1 | ● | |
| 50 | Looxor | 02 - 05 | 1 | ● | |
| 50 | Looxor | 06 - | 1 | ● | |
| 50 | Ludix (All models 10") | 04 - 09 | 1 | ● | |
| 50 | Ludix 2 Trend 12" | 07 - 10 | 1 | ● | |
| 50 | Ludix Blaster Furious | 09 - | 1 | ● | |
| 50 | Ludix Blaster RCUP | 09 - | 1 | ● | |
| 50 | Ludix Blaster RS12 | 09 - | 1 | ● | |
| 50 | Ludix Elegance 14" | 04 - 09 | 1 | ● | |
| 50 | Metal-X (All models) | 03 - 06 | 1 | ● | |
| 50 | Speedake (AJP Caliper) | 94 - | 1 | ● | |
| 50 | Speedfight 2 Air cooled | 01 - 08 | 1 | ● | |
| 50 | Speedfight 2 Furious/WRC/X-Race | 03 - 08 | 1 | ● | |
| 50 | Speedfight 2 Liquid Cooled | 01 - 08 | 1 | ● | |
| 50 | Speedfight LC (AJP Caliper) | 96 - 00 | 1 | ● | |
| 50 | Squab (AJP Caliper) | 94 - | 1 | ● | |
| XP S6 | 50 | Street / Super Motard | 04 - | | ● |
| XPS | 50 | Street / Top Road | 03 - 09 | | ● |
| XPS | 50 | Super Motard | 03 - 10 | | ● |
| XP6 | 50 | Supermotard | 03 - 09 | 1 | ● |
| 50 | TKR / TKR WRC | 05 - | 1 | ● | |
| 50 | TKR Street Zone / WRC | 03 - | 1 | ● | |
| XPS | 50 | Track / Enduro | 03 - 09 | 1 | ● |
| XP6 | 50 | Trail | 04 - 05 | 1 | ● |
| 50 | Trekker Metal X | 01 - | 1 | ● | |

3015 suite

PEUGEOT

| | | | | | |
|------|---------------------------------|---------|---|---|---|
| 50 | Trekker Road (AJP Caliper) | 98 - | 1 | ● | |
| 50 | Trekker Street Board | 00 - | 1 | ● | |
| 50 | Trekker Urban Black | 00 - | 1 | ● | |
| 50 | Vivacity (AJP Caliper) | 99 - 07 | 1 | ● | |
| 50 | Zenith LS | 96 - 99 | 1 | ● | |
| XR-6 | | | | | ● |
| 50 | | 02 - 07 | | | ● |
| 100 | Elyséo | 02 - | 1 | ● | ● |
| 100 | Elyséo (AJP Caliper) | 98 - 01 | 1 | ● | ● |
| 100 | Looxor | 01 - 04 | 1 | ● | ● |
| 100 | Speedfight (AJP Caliper) | 97 - | 1 | ● | ● |
| 100 | Speedfight 2 Furious/WRC/X-Race | 03 - | 1 | ● | ● |
| 100 | Squab | 98 - | 1 | ● | ● |
| 100 | Trekker Road | 98 - | 1 | ● | ● |
| 100 | Vivacity (AJP Caliper) | 99 - 07 | 1 | ● | ● |
| 125 | Elyséo (AJP Caliper) | 98 - 01 | 1 | ● | ● |
| 125 | Looxor | 03 - 08 | | | ● |
| 150 | Looxor | 03 - | | | ● |
| | AJP Caliper | | | ● | |

PIAGGIO

| | | | | | |
|-----|--------|------|---|---|--|
| 50 | Diesis | 02 - | 1 | ● | |
| 100 | Diesis | 02 - | 1 | ● | |

RIEJU

| | | | | | |
|-----|------------------------------------|---------|---|---|---|
| SMX | 50 (Cast Wheel) | 07 - 08 | 1 | ● | ● |
| MRX | 50 Castrol | 01 - 02 | | | ● |
| RR | 50 Castrol | 00 - 02 | | | ● |
| | 50 FD4 Super Marathon | 85 | 1 | ● | ● |
| | 50 First / H2O | 97 - | 1 | ● | ● |
| RS2 | 50 Matrix (AJP Caliper) | 02 - 08 | | | ● |
| RS2 | 50 Matrix (J.Juan Caliper) | 07 - 09 | | | ● |
| RS2 | 50 NKD | 05 | | | ● |
| | 50 NKD | 07 | | | ● |
| RS2 | 50 Pro (AJP Caliper) | 06 - 10 | | | ● |
| RS2 | 50 Pro (J.Juan Caliper) | 07 - 10 | | | ● |
| MRX | 50 Pro / Top | 04 - 08 | | | ● |
| SMX | 50 Pro Street (Cast Wheel) | 06 - 08 | | | ● |
| SMX | 50 Pro Supermotard / Top | 04 - 07 | | | ● |
| | 50 Spike | 04 - 06 | 1 | ● | ● |
| RRX | 50 Spike (17" Cast wheel) | 06 - 09 | 1 | ● | ● |
| RRX | 50 Spike (17" wheel / Spoke Wheel) | 03 - 08 | 1 | ● | ● |
| | 50 Spike pro | 04 | | | ● |
| | 50 Spike X50 | 06 - 07 | 1 | ● | ● |
| RR | 50 Sport | 03 - 06 | 1 | ● | ● |
| | 50 Tango | 07 - 10 | | | ● |
| | 50 Tango Motard | 09 - 10 | | | ● |
| RR | 50 Thunderfire | 97 - 02 | 1 | ● | ● |
| MRX | 50 | 03 - 08 | 1 | ● | ● |
| RRX | 50 | 06 - 09 | 1 | ● | ● |
| RS1 | 50 | 97 - 00 | 1 | ● | ● |
| SMX | 50 | 02 - 06 | 1 | ● | ● |
| RS1 | 50 | 01 - | | | ● |
| 75 | K6 / P6 | 87 | 1 | ● | ● |
| RST | 80 | 91 - | 1 | ● | ● |

ROXON

| | | | | | |
|----|---------|------|---|---|---|
| 50 | DUEL SM | 06 - | 1 | ● | ● |
| 50 | DUEL TT | 06 - | 1 | ● | ● |

SACHS

| | | | | | |
|----|-------------------|---------|--|--|---|
| 50 | Madass (2 stroke) | 04 - 05 | | | ● |
| 50 | Madass (4 stroke) | 04 - 05 | | | ● |

SHERCO

| | | | | | |
|----|------------------|---------|--|--|---|
| 50 | Enduro (2T) | 02 - 07 | | | ● |
| 50 | Supermotard (2T) | 02 - 07 | | | ● |

SIMSON

| | | | | | |
|-----|------|------|---|---|--|
| 125 | Star | 99 - | 1 | ● | |
|-----|------|------|---|---|--|

SUZUKI

| | | | | | |
|-----|---------------------------------------|---------|---|---|---|
| DR | 50 Big | 89 - | 1 | ● | ● |
| UF | 50 Estilete | 00 - 02 | 1 | ● | ● |
| SMX | 50 Super Motard | 98 - | 1 | ● | ● |
| AY | 50 WRK1-WRK5 Katana (AJP Caliper) | 01 - 05 | 1 | ● | ● |
| AY | 50 WRK2-WRK4 Katana (Grimeca Caliper) | 99 - 04 | | | ● |

YAMAHA

| | | | | | |
|-----|------|---------|---|---|---|
| RMX | 50 | 98 - | 1 | ● | ● |
| DT | 50 R | 04 - | 1 | ● | ● |
| TZR | 50 | 03 - 08 | | | ● |

SCOOTER MAXI-SCOOTER

MSC

3017

Dim./Size

— 90 mm
↑ 49 mm
H 9 mm

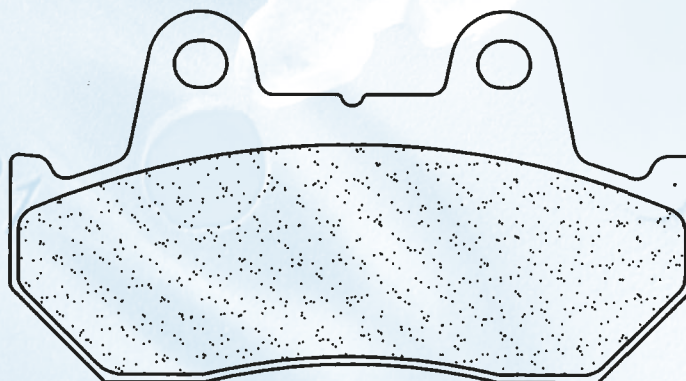

HONDA

| | | | | | |
|----|--------------------|---------|---|---|---|
| CN | 250 Helix (Fusion) | 92 | 1 | ● | ● |
| CN | 250 Scooter | 88 - 92 | 1 | ● | ● |
| CN | 250 Scooter | 93 - | 1 | ● | ● |
| CN | 250 Spazio | 90 - 97 | 1 | ● | ● |

SCOOTER MAXI-SCOOTER

SC MSC

3018

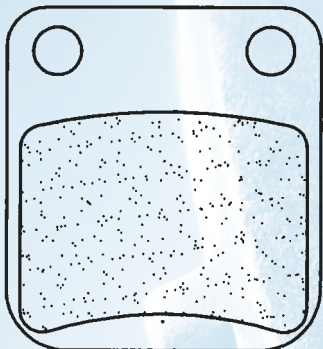

Dim./Size
 — 41,2mm
 ↑ 45,2 mm
 H 8 mm

DAELIM

| | | | | |
|----------------|------------------|---------|---|---|
| 50 | Cordi | 06 - | 1 | ● |
| 50 | Delfino | 99 - | 1 | ● |
| 50 | E-Five | 03 - | 1 | ● |
| 50 | History | 01 - | 1 | ● |
| 50 | Message II | 02 - | 1 | ● |
| 50 | S-Five | 01 - 05 | 1 | ● |
| 50 | Tapo | 99 - | 1 | ● |
| 50 | Vivo | 99 - | 1 | ● |
| 100 | Delfino | 99 - | 1 | ● |
| 125 | DLX / Otello DLX | 01 - | 1 | ● |
| 125 | History | 01 - | 1 | ● |
| NS | 125 II | 00 - | 1 | ● |
| 125 | Message II | 00 - | 1 | ● |
| 125 | Otello | 99 - | 1 | ● |
| 125 | Otello | 08 - | | ● |
| 125 | S2 FI | 07 - | | ● |
| 125 | U3 FI | 07 - | | ● |
| S2 | 125 | 05 - | | ● |
| S2 | 250 Free Wind | 05 - | | ● |
| HONDA | | | | |
| SC | 50 1-ZX | 92 - | 1 | ● |
| SP | 50 | - 91 | 1 | ● |
| PEUGEOT | | | | |
| 125 | Sum-Up | 08 - | 1 | ● |
| SACHS | | | | |
| 50 | Madass (4T) | 06 - 09 | | ● |
| 125 | Madass (4T) | 06 - 09 | | ● |

SCOOTER MAXI-SCOOTER

SC MSC

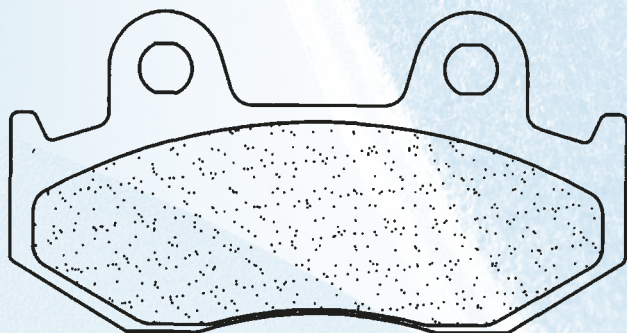

Dim./Size
 — 81,1 mm
 ↑ 42 mm
 H 8,5 mm

HONDA

| | | | | |
|----------------|----------------------------|---------|---|---|
| 100 | Lead | 00 - | 1 | ● |
| NES | 125 @ | 01 - | 1 | ● |
| SH | 125 | 02 - 08 | 1 | ● |
| NES | 150 @ | 01 - | 1 | ● |
| SH | 150 | 02 - 08 | 1 | ● |
| CH | 250 Spacy | 85 - 86 | 1 | ● |
| CH | 250 Spacy / Freeway Fusion | 88 - | 1 | ● |
| CN | 250 Spazio | 88 - 89 | 1 | ● |
| ITALJET | | | | |
| 50 | Rollercraft | 08 - | 1 | ● |
| PGO | | | | |
| 50 | T-Rex 3 | 02 - | 1 | ● |

3019

SCOOTER MAXI-SCOOTER

SC MSC

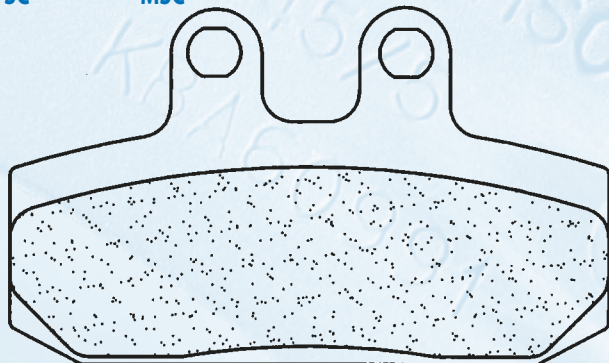

Dim./Size
 — 79 mm
 ↑ 47,1 mm
 H 7,5 mm

HONDA

| | | | | |
|-----------------|--------------|---------|---|---|
| SJ | 50 Bali | 93 - 99 | 1 | ● |
| EX | 100 Bali | 96 - | 1 | ● |
| SJ | 100 Bali | 97 - | 1 | ● |
| MALAGUTI | | | | |
| 125 | Runner | 87 - | 1 | ● |
| 500 | Spidermax GT | 04 - | 2 | ● |
| 500 | Spidermax RS | 09 - | 2 | ● |

3020

SCOOTER MAXI-SCOOTER

MSC

3021

Dim./Size

79 mm

47,1 mm

8,7 mm

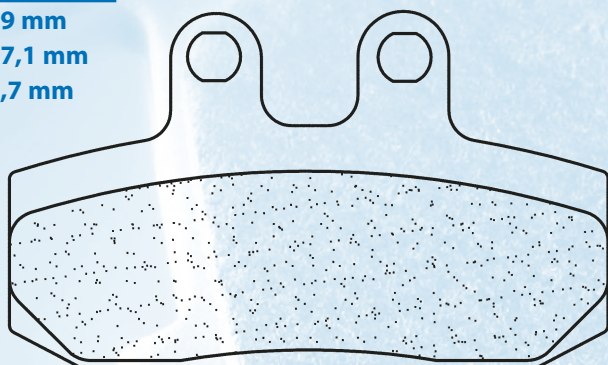

APRILIA

| | | | | |
|-----|----------------------------|-----------|---|---|
| 125 | Léonardo (Grimeca Caliper) | 99 - | 1 | ● |
| 125 | Scarabéo / Scarabéo GT | 99 - 03 | 1 | ● |
| 125 | Sportcity | 05 - | 1 | ● |
| 150 | Léonardo (Grimeca Caliper) | 99 - | 1 | ● |
| 150 | Scarabeo | 99 - 03 | 1 | ● |
| 200 | Scarabéo / Scarabéo GT | 02 - 03 | 1 | ● |
| 200 | Sportcity | 05 - | 1 | ● |
| 250 | Léonardo (Grimeca Caliper) | 99 - | 1 | ● |
| 250 | Sportcity ie | 07 - | 1 | ● |
| 300 | Léonardo (Grimeca Caliper) | 05 - | 1 | ● |
| 400 | Scarabéo ie | 07 - | 1 | ● |
| 500 | Atlantic | 02 - 05 L | 1 | ● |
| 500 | Scarabéo | 03 - 09 L | 1 | ● |
| 500 | Scarabéo Class | 10 - | 1 | ● |

SIMSON

| | | | | |
|-----|---------|------|---|---|
| 125 | Schikra | 99 - | 1 | ● |
|-----|---------|------|---|---|

SCOOTER MAXI-SCOOTER

SC

MSC

3022

Dim./Size

85 mm

42,5 mm

6,5 mm

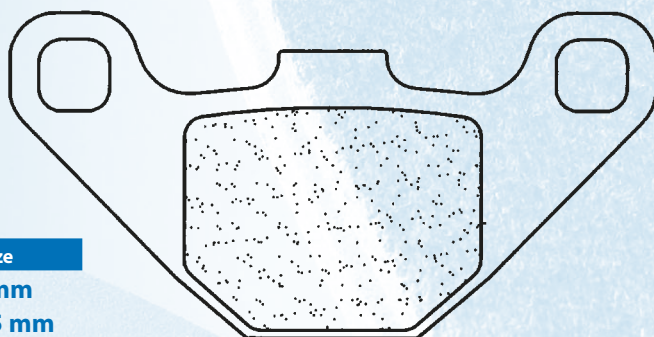

Dim./Size

47,4 mm

37,1 mm

8,7 mm

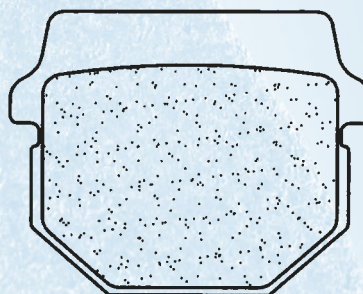

ADLY

| | | | | |
|----|-----------------|-----|---|-----|
| 50 | Panther | 01- | 1 | ● |
| 50 | Silver Fox | 06- | 1 | ● |
| 50 | Super Sonic | 00- | 2 | ● |
| RS | 50 Super Sonic | 06- | 1 | ● ● |
| 50 | Thunderbike | 97- | 1 | ● |
| RT | 100 Panther | 01- | 1 | ● |
| RT | 100 Silver Fox | 06- | 1 | ● |
| RT | 100 Super Sonic | 01- | 2 | ● |
| RT | 100 Thunderbike | 01- | 2 | ● ● |
| RT | 125 Super Sonic | 01- | 2 | ● |
| RT | 125 Thunderbike | 01- | 2 | ● ● |

AEON

| | | | | |
|-----|--------|-----|---|---|
| 50 | Aero | 06- | 1 | ● |
| 50 | Regal | 06- | 1 | ● |
| 50 | Torch | 06- | 1 | ● |
| 90 | Regal | 06- | 1 | ● |
| 100 | Pulsar | 06- | 1 | ● |
| 110 | Aero | 06- | 1 | ● |
| 110 | Pulsar | 06- | 1 | ● |
| 125 | Pulsar | 06- | 1 | ● |
| 150 | Pulsar | 06- | 1 | ● |

CPI

| | | | | |
|----|---------|---------|---|---|
| 50 | Hussar | 01 - 02 | 1 | ● |
| 50 | Mars | 01 - | 1 | ● |
| 50 | Popcorn | 01 - 02 | 1 | ● |

FANTIC

| | | | | |
|----|-----------------|------|--|---|
| 50 | Regolarna Casa | 08 - | | ● |
| 50 | Supersei Molard | 08 - | | ● |

GARELLI

| | | | | |
|-----|--------|------|---|---|
| 125 | Raider | 02 - | 1 | ● |
|-----|--------|------|---|---|

GILERA

| | | | | |
|----|--------|------|--|---|
| 50 | Eaglet | 97 - | | ● |
|----|--------|------|--|---|

HYOSUNG

| | | | | |
|----|----------------|------|---|---|
| 50 | Avanti | 99 - | 1 | ● |
| 50 | Rush | 97 - | 1 | ● |
| 50 | Sense | 98 - | 1 | ● |
| 50 | Super Cab | 95 - | 1 | ● |
| 50 | Super Cab Plus | 98 - | 1 | ● |

HYOSUNG

| | | | | |
|----|----------------|------|---|---|
| SB | 50 | 00 - | 1 | ● |
| SD | 50 | 00 - | 1 | ● |
| SF | 50 | 99 - | 1 | ● |
| | 100 Cab | 98 - | 1 | ● |
| EZ | 100 | 00 - | 1 | ● |
| KR | 110 Master | 04 - | 1 | ● |
| | 110 Midas Plus | 98 - | 1 | ● |
| FX | 110 | 02 - | 1 | ● |

ITALJET

| | | | | |
|-----|-----------|---------|---|---|
| 100 | Millenium | 00 - 01 | 1 | ● |
| 125 | Millenium | 00 - 01 | 1 | ● |
| 150 | Millenium | 00 - 01 | 1 | ● |

KEEWAY

| | | | | |
|-----|-----------|------|---|---|
| 50 | Flash | 07 - | 1 | ● |
| 50 | Hurricane | 06 - | 1 | ● |
| 90 | Hurricane | 06 - | 1 | ● |
| 125 | Matrix | 06 - | 1 | ● |

KREIDLER

| | | | | |
|----|------------|------|---|---|
| 25 | Florett XL | 99 - | 1 | ● |
| 50 | Florett | 99 - | 1 | ● |

MAICO

| | | | | |
|-----|--------------------|------|---|---|
| 50 | Cruiser | 99 - | 1 | ● |
| R-1 | 50 Superbike | 99 - | 1 | ● |
| 50 | Thunderbike I / II | 99 - | 1 | ● |
| 50 | Trafficjammer | 99 - | 1 | ● |

MALAGUTI

| | | | | |
|-----|------|------|--|---|
| 125 | Blog | 10 - | | ● |
| 160 | Blog | 10 - | | ● |

MZ / MUZ

| | | | | |
|-----|---------|---------|---|---|
| 50 | Moskito | 99 - 02 | 1 | ● |
| 125 | Moskito | 02 | 1 | ● |

PEUGEOT

| | | | | |
|----|-----------------------------------|---------|---|---|
| 50 | Buxy (Hengtong Caliper) | 94 - | 1 | ● |
| 50 | Elyseo (Hengtong Caliper) | 98 - | 1 | ● |
| 50 | Kisbee (4T) | 10 - | 1 | ● |
| 50 | Speedake (Hengtong Caliper) | 94 - | 1 | ● |
| 50 | Speedflight LC (Hengtong Caliper) | 96 - 00 | 1 | ● |
| 50 | Squab (Hengtong Caliper) | 94 - | 1 | ● |

3022 suite

PEUGEOT

| | | | | |
|-----|-------------------------------------|------|---|---|
| 50 | Trekker Off Road (Hengtong Caliper) | 98 - | 1 | ● |
| 50 | Vivacity (Hengtong Caliper) | 05 - | 1 | ● |
| 50 | Zenith (Hengtong Caliper) | 96 - | 1 | ● |
| 100 | Speedfight (Hengtong Caliper) | 97 - | 1 | ● |
| 100 | Vivacity (Hengtong Caliper) | 05 - | 1 | ● |

PGO

| | | | | |
|----|-------------|------|---|---|
| 50 | Big Max | 03 - | 1 | ● |
| 50 | Comet Sport | 91 - | 1 | ● |
| 50 | Galaxy | 91 - | 1 | ● |
| 50 | Road 66 | 95 - | 1 | ● |

PS

| | | | | |
|----|--------|------|---|---|
| 50 | | 93 - | 1 | ● |
| 90 | Galaxy | 92 - | 1 | ● |

PIAGGIO

| | | | | | |
|-----|----|----------------|------|---|---|
| NRG | 50 | Power DD | 06 - | 1 | ● |
| NRG | 50 | Purejet | 06 - | 1 | ● |
| NRG | 50 | Silver Bullett | 10 | 1 | ● |
| | 50 | Typhoon | 06 - | 1 | ● |

SIAM

| | | | | | |
|--|-----|-----|------|---|---|
| | 50 | Mat | 97 - | 1 | ● |
| | 100 | Mat | 97 - | 1 | ● |

SULA

| | | | | | |
|--|-----|--------------|------|---|---|
| | 50 | Thunder Bird | 99 - | 1 | ● |
| | 100 | Thunder Bird | 99 - | 1 | ● |
| | 125 | Thunder Bird | 99 - | 1 | ● |

SUZUKI

| | | | | | |
|------|-----|----------------------------------|---------|---|---|
| AH | 50 | N Address (CA1GA) Italian Market | 92 - 95 | 1 | ● |
| ZZ | 50 | Scooter | 92 - | 1 | ● |
| CC | 50 | Tune | 92 - | 1 | ● |
| AJ | 50 | ZZ Sepia | 92 - | 1 | ● |
| LIDO | 75 | Style | 84 - | 1 | ● |
| AH | 80 | Address | 88 - | 1 | ● |
| AH | 80 | Scooter | 92 - 94 | 1 | ● |
| AJ | 80 | ZZ Sepia | 90 - | 1 | ● |
| AH | 100 | Address | 91 - 96 | 1 | ● |
| UE | 125 | CTK1 | 01 - 03 | 1 | ● |
| AN | 125 | HKK5 | 06 - 08 | 1 | ● |
| CS | 125 | LIDO | 90 - | 1 | ● |
| UE | 150 | CTK1 | 02 - | 1 | ● |

TGB

| | | | | | |
|--|-----|-----------------------------------------|---------|---|---|
| | 50 | 303 Revolution | 02 - 03 | 1 | ● |
| | 50 | 303R Hawk / laser | 04 - | 1 | ● |
| | 50 | City (2T) / City (4T) | 07 - | 1 | ● |
| | 50 | Delivery / Express (From E/F no 609100) | 06 - 09 | 1 | ● |
| | 50 | F409 Cruise | 02 - 05 | 1 | ● |
| | 50 | Generic Trigger | 02 - | 1 | ● |
| | 50 | High Wheel | 02 - | 1 | ● |
| | 50 | X Bullet R | 06 - | | ● |
| | 125 | 204 Classic | 03 - 04 | 1 | ● |
| | 125 | 303 Revolution | 02 - 03 | 1 | ● |
| | 125 | F409 | 02 - 05 | 1 | ● |
| | 125 | X-Bullet R | 08 - | | ● |

SCOOTER MAXI-SCOOTER

SC

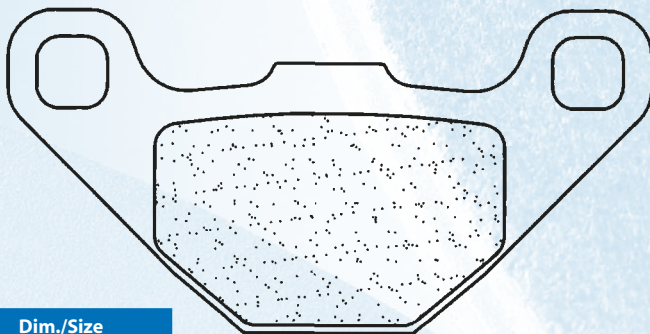

Dim./Size

85 mm

42,5 mm

6,5 mm

3024

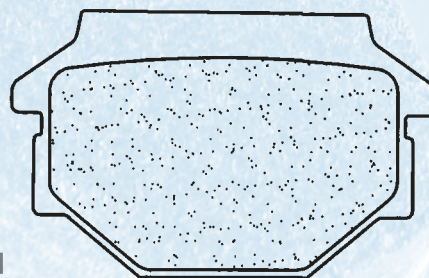

Dim./Size

56 mm

34,9 mm

8,7 mm

MALAGUTI

| | | | | | |
|------|----|--|---------|---|---|
| F-10 | 50 | | 92 - 93 | 1 | ● |
|------|----|--|---------|---|---|

PEUGEOT

| | | | | | |
|----|----|----------------|------|---|---|
| SV | 50 | Rolland Garros | 93 - | 1 | ● |
| SV | 50 | T | 93 - | 1 | ● |
| SV | 50 | Sport | 93 - | 1 | ● |

SULA

| | | | | | |
|--|----|-----------|------|---|---|
| | 50 | City Bird | 99 - | 1 | ● |
|--|----|-----------|------|---|---|

SCOOTER MAXI-SCOOTER

MSC

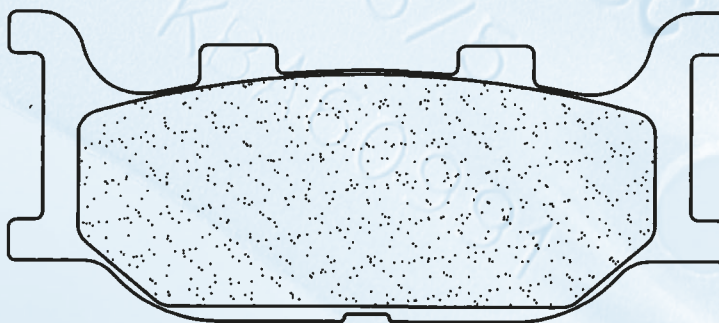

Dim./Size

94 mm

40,7 mm

10 mm

BAOXIN

| | | | | | |
|----|-----|---|------|---|---|
| BX | 125 | L | 97 - | 1 | ● |
|----|-----|---|------|---|---|

QUINGOI

| | | | | | |
|----|-----|----|------|---|---|
| QM | 125 | 2V | 02 - | 1 | ● |
|----|-----|----|------|---|---|

ITALJET

| | | | | | |
|--|-----|---------|------|---|---|
| | 125 | Jupiter | 02 - | 1 | ● |
| | 150 | Jupiter | 02 - | 1 | ● |
| | 250 | Jupiter | 02 - | 1 | ● |

MBK

| | | | | | |
|--|-----|----------|---------|---|---|
| | 250 | Skyliner | 96 - 98 | 1 | ● |
| | 250 | Skyliner | 99 - 02 | 1 | ● |
| | 400 | Skyliner | 04 - | 1 | ● |

YAMAHA

| | | | | | |
|----|-----|------------------|---------|---|---|
| CP | 250 | Maxam / Morphus | 05 - 08 | 1 | ● |
| YP | 250 | Majesty | 96 - 98 | 1 | ● |
| YP | 250 | Majesty DX / ABS | 98 - 99 | 1 | ● |
| YP | 250 | Majesty | 99 - 03 | 1 | ● |
| YP | 400 | Majesty | 05 - | 2 | ● |
| XP | 500 | T-Max (S/T/V) | 04 - 07 | 2 | ● |

3025

SCOOTER MAXI-SCOOTER

MSC

3026

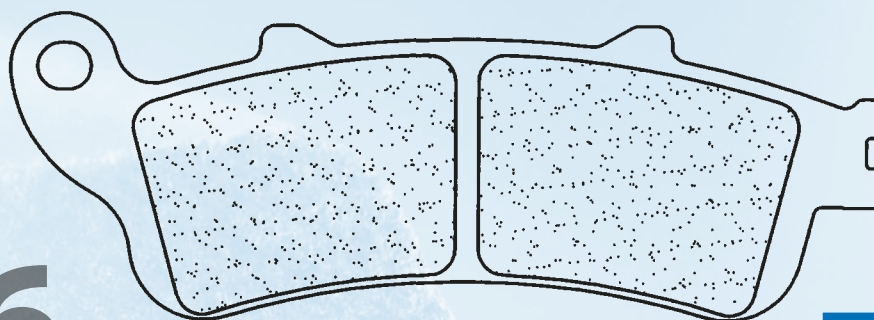

Dim./Size

→ 115 mm
↑↓ 38,8 mm
H 8,5 mm

HONDA

| | | | | | |
|-----|-----|-------------------------------|---------|---|---|
| FES | 125 | Panthéon | 98 - 02 | 1 | ● |
| FES | 125 | Panthéon | 03 - | 1 | ● |
| FES | 150 | Panthéon | 99 - 02 | 1 | ● |
| FES | 150 | Panthéon | 03 - | 1 | ● |
| FES | 250 | Foresight | 98 - 99 | 1 | ● |
| FES | 250 | Foresight | 00 - | 1 | ● |
| NSS | 250 | Forza | 00 - 04 | 1 | ● |
| NSS | 250 | Jazz | 01 - 04 | 1 | ● |
| FJS | 400 | Silver Wing | 06 - 08 | 1 | ● |
| FJS | 600 | Silver Wing / Silver Wing ABS | 01 - | 2 | ● |

SCOOTER MAXI-SCOOTER

SC

Dim./Size

→ 45,8 mm
↑↓ 52,7 mm
H 6,4 mm



CPI

| | | | |
|---------------|-----------------|---------|-----|
| 50 | GTS | 02 | ● |
| MBK | | | |
| 50 | Nitro | 97 - | ● |
| 50 | Stunt | 99 - | 1 ● |
| 100 | Nitro | 01 - | ● |
| YAMAHA | | | |
| YQ | Aerox / Aerox R | 97 - | ● |
| EW | Slider | 00 - 05 | 1 ● |

3027

SCOOTER MAXI-SCOOTER

MSC

Dim./Size

→ 94 mm
↑↓ 36 mm
H 7,6 mm

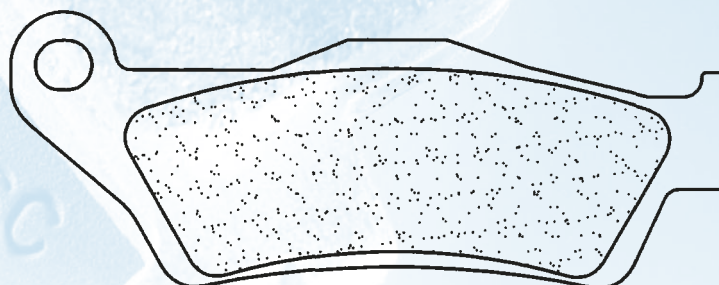

GILERA

| | | | | | |
|----|-----|----------|---------|---|---|
| GP | 500 | Nexus | 04 - | 2 | ● |
| | 800 | | 08 - | 2 | ● |
| | 125 | Skyliner | 98 - 00 | 1 | ● |
| | 125 | Skyliner | 01 - 10 | 1 | ● |
| | 125 | Thunder | 01 - 03 | 1 | ● |

MBK

| | | | | | |
|--|-----|----------|---------|---|-----|
| | 150 | Skyliner | 01 - | 1 | ● |
| | 150 | Thunder | 01 - 03 | 1 | ● |
| | 150 | Vertex | 97 - | 1 | ● |
| | 180 | Skyliner | 04 - | 1 | ● |
| | 300 | Kilibre | 03 - 04 | 1 | ● ● |

PIAGGIO

| | | | | |
|-----|------------|---------|---|---|
| 400 | Beverly ie | 07 - | 1 | ● |
| 500 | X9 Evo | 03 - 06 | 2 | ● |
| 500 | X9 Evo ABS | 04 - | 2 | ● |

SUZUKI

| | | | | | |
|----|-----|---------|---------|---|---|
| UH | 125 | Burgman | 02 - 06 | 1 | ● |
| UH | 150 | Burgman | 04 - 06 | 1 | ● |

YAMAHA

| | | | | | |
|----|-----|-----------|---------|---|---|
| YP | 125 | Majesty | 98 - 00 | 1 | ● |
| YP | 125 | Majesty | 01 - 09 | 1 | ● |
| XQ | 125 | Maxster | 01 - 03 | 1 | ● |
| YP | 150 | Majesty | 01 - | 1 | ● |
| XQ | 150 | Maxster | 01 - | 1 | ● |
| YP | 180 | R Majesty | 04 - | 1 | ● |
| YP | 180 | R Majesty | 03 | 1 | ● |
| XC | 300 | Versity | 03 - 05 | 1 | ● |
| XC | 300 | Versity | 06 - | ● | ● |

SCOOTER MAXI-SCOOTER

SC MSC

3029

Dim./Size

61 mm

27 mm

7 mm

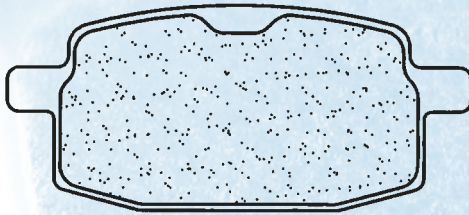

GARELLI

| | | | | | |
|-----|----|---------|------|---|---|
| SR | 50 | Pony | 95 - | 1 | ● |
| PMX | 50 | Rally | 00 - | 1 | ● |
| | 50 | Starter | 02 - | 1 | ● |
| CPR | 50 | | 02 - | 1 | ● |
| FX | 50 | | 02 - | 1 | ● |

ITALJET

| | | | | | |
|--|----|----------|------|---|---|
| | 50 | Bazooka | 93 - | 1 | ● |
| | 50 | Cruise | 95 - | 1 | ● |
| | 50 | Pista 2 | 93 - | 1 | ● |
| | 50 | Scoop | 93 - | 1 | ● |
| | 50 | Yankee 8 | 94 - | 1 | ● |

LEM

| | | | | | |
|--|----|-------|------|---|---|
| | 50 | Flash | 94 - | 1 | ● |
|--|----|-------|------|---|---|

MBK

| | | | | | |
|--|----|--------|------|---|---|
| | 50 | Target | 92 - | 1 | ● |
|--|----|--------|------|---|---|

MZ / MUZ

| | | | | | |
|--|----|-----------------|---------|---|---|
| | 50 | Moskito FB | 97 - 03 | 1 | ● |
| | 50 | Moskito SX JP50 | 00 - 03 | 1 | ● |

PEUGEOT

| | | | | | |
|--|----|-------------|------|---|---|
| | 50 | V-Clic (4T) | 08 - | 1 | ● |
|--|----|-------------|------|---|---|

PGO

| | | | | | |
|--|----|---------------|---------|---|---|
| | 50 | Big Max | 94 - 02 | 1 | ● |
| | 50 | Big Max Sport | 96 - | 1 | ● |
| | 50 | Comet | 93 - | 1 | ● |
| | 50 | EPS | 96 - | 1 | ● |
| | 50 | Hot | 97 - | 1 | ● |
| | 50 | Mega | 96 - | 1 | ● |
| | 50 | Tornado | 96 - | 1 | ● |

PMX

| | | | | | |
|--|-----|--------------|------|---|---|
| | 50 | | 98 - | 1 | ● |
| | 80 | 1.25 Big Max | 94 - | 1 | ● |
| | 90 | Big Max | 96 - | 1 | ● |
| | 90 | Tornado | 00 - | 1 | ● |
| | 100 | Big Max | 94 - | 1 | ● |

PMX

| | | | | | |
|--|-----|---------|------|---|---|
| | 110 | | 00 - | 1 | ● |
| | 125 | Kung Fu | | | ● |
| | 125 | Tornado | 96 - | 1 | ● |

SHE-LUNG

| | | | | | |
|--|-----|--------|------|---|---|
| | 50 | Falcon | 97 - | 1 | ● |
| | 125 | Mars | 97 - | 1 | ● |

SIAMOTO

| | | | | | |
|--|----|--------|------|---|---|
| | 50 | Birdie | 02 - | 1 | ● |
|--|----|--------|------|---|---|

TGB

| | | | | | |
|--|-----|---------|------|--|---|
| | 250 | Dynasty | 06 - | | ● |
|--|-----|---------|------|--|---|

YAMAHA

| | | | | | |
|------|-----|-------------|---------|---|---|
| CS | 50 | JOG (Spain) | 88 - | 1 | ● |
| CY | 50 | RS JOG R | 96 - | 1 | ● |
| CR | 50 | Target | 91 - | 1 | ● |
| CR | 50 | Z | 91 - 95 | 1 | ● |
| YA | 50 | ZA Jog Z | 95 - | 1 | ● |
| BW'S | 100 | | 96 - | 1 | ● |

ADLY

| | | | | | |
|----|-----|-------------------------|-------|---|---|
| | 25 | Silver Fox | 00-05 | 1 | ● |
| | 50 | Cat | 01- | 1 | ● |
| | 50 | Cosy | 01- | 1 | ● |
| | 50 | Fox | 00- | 1 | ● |
| | 50 | Fox Plus | 01- | 1 | ● |
| | 50 | Jet | 96- | 1 | ● |
| | 50 | Pista, Pista Twin Light | 96- | 1 | ● |
| RT | 50 | Road Tracer | 02- | 1 | ● |
| | 50 | Silver Fox | 00-05 | 1 | ● |
| | 70 | Fox plus | 01- | 1 | ● |
| | 70 | Pista, Pista Twin Light | 01- | 1 | ● |
| | 80 | Cosy | 01- | 1 | ● |
| RT | 90 | Road Tracer | 02- | 1 | ● |
| | 100 | Cat | 01- | 1 | ● |
| | 100 | Jet | 96- | 1 | ● |
| RT | 100 | Road Tracer | 02- | 1 | ● |
| | 100 | Silver Fox | 01-05 | 1 | ● |
| | 125 | Cat | 01- | 1 | ● |

BENELLI

| | | | | | |
|------|----|------|--|---|---|
| KB-X | 50 | Race | | 1 | ● |
|------|----|------|--|---|---|

CAGIVA

| | | | | | |
|--|----|------|------|---|---|
| | 50 | City | 08 - | 1 | ● |
|--|----|------|------|---|---|

FANTIC

| | | | | | |
|--|----|-----------|------|---|---|
| | 50 | Big Wheel | 94 - | 1 | ● |
| | 50 | Grinta | 95 - | 1 | ● |
| | 50 | Leader | 95 - | 1 | ● |
| | 50 | Pony SR | 93 - | 1 | ● |
| | 50 | Queenie | 95 - | 1 | ● |

SCOOTER MAXI-SCOOTER

SC MSC

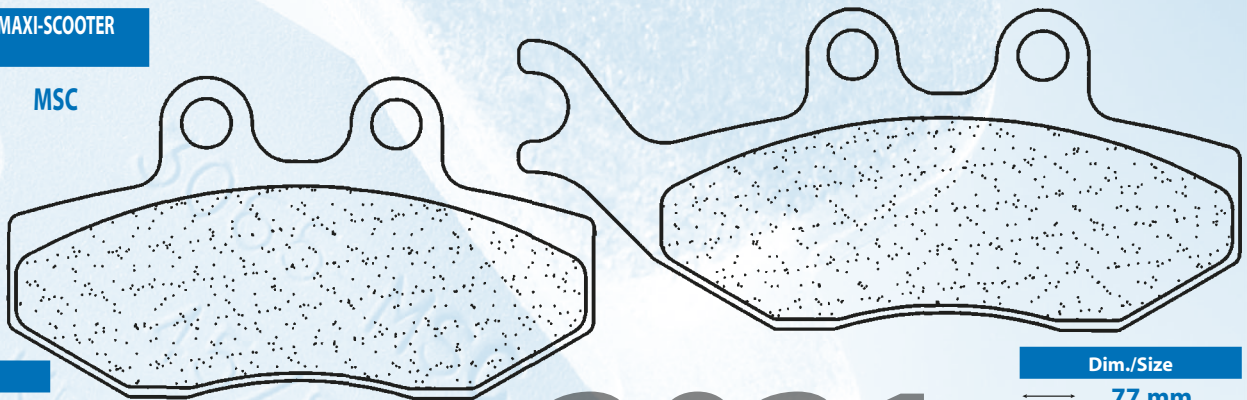

Dim./Size

94,5 mm

42 mm

7,5 mm

3031

Dim./Size

77 mm

42 mm

7,5 mm



DERBI

| | | | | | |
|--|----|-----------------------|------|---|---|
| | 50 | Black Devil | 04 - | 1 | ● |
| | 50 | R DRD | 05 - | 1 | ● |
| | 50 | Senda SM DRD Black Ed | 03 - | 1 | ● |
| | 50 | SM DRD / Racer | 05 - | 1 | ● |
| | 50 | SM X-Treme / X-Race | 05 - | 1 | ● |

FACTORY

| | | | | | |
|----|----|--------|------|---|---|
| SM | 50 | Chrono | 04 - | 1 | ● |
| SP | 50 | Chrono | 04 - | 1 | ● |
| RP | 50 | Desert | 04 - | 1 | ● |
| YR | 50 | Desert | 04 - | 1 | ● |

FANTIC

| | | | | | |
|--|----|-----------------|------|---|---|
| | 50 | Regolarna Casa | 08 - | 1 | ● |
| | 50 | Supersei Motard | 08 - | 1 | ● |

APRILIA

| | | | | | |
|--|----|-----------------|---------|---|---|
| | 50 | MX | 03 - | 1 | ● |
| | 50 | RS / RS Replica | 00 - 05 | 1 | ● |
| | 50 | RS Tuono | 03 - | 1 | ● |
| | 50 | RX | 90 - | 1 | ● |
| | 50 | RX Racing | 04 - | 1 | ● |

BENELLI

| | | | | | |
|--|-----|-------------|------|---|---|
| | 400 | Velvet Dusk | 03 - | 1 | ● |
|--|-----|-------------|------|---|---|

CPI

| | | | | | |
|--|-----|-----------|------|---|---|
| | 50 | GTR | 02 | 1 | ● |
| | 50 | GTS | 02 | 1 | ● |
| | 125 | GTR / GTS | 02 - | 1 | ● |
| | 200 | GTR / GTS | 02 - | 1 | ● |

| GAS GAS | | | | | |
|--------------------|-----|-----------------------------|---------|---|---|
| EC | 50 | Rookie | 05 - | 1 | ● |
| GENERIC | | | | | |
| | 50 | Toxic | 07 - | 1 | ● |
| | 50 | Trigger SM | 06 - | 1 | ● |
| | 50 | Trigger SM Competition | 08 - | 1 | ● |
| | 50 | Trigger X | 06 - | 1 | ● |
| | 50 | Trigger X Competition | 08 - | 1 | ● |
| GILERA | | | | | |
| DNA | 50 | (Grimeca Caliper) | 00 - | 1 | ● |
| | 50 | Runner PJ | 06 - | 1 | ● |
| | 50 | Runner SP | 06 - | 1 | ● |
| DNA | 125 | (Grimeca Caliper) | 01 - | 1 | ● |
| VX | 125 | Runner 4T (Grimeca Caliper) | 01 - | 1 | ● |
| FX | 125 | Runner/SP (Grimeca Caliper) | 00 - | 1 | ● |
| | 175 | Mad Mud | 02 - | 1 | ● |
| DNA | 180 | (Grimeca Caliper) | 01 - | 1 | ● |
| FXR | 180 | Runner | 98 - 99 | 1 | ● |
| VXR | 180 | Runner 4T (Grimeca Caliper) | 01 - | 1 | ● |
| FXR | 180 | Runner/SP (Grimeca Caliper) | 00 - | 1 | ● |
| VXR | 200 | Runner 4T (Grimeca Caliper) | 01 - | 1 | ● |
| FX | 200 | Runner SP | 98 - | 1 | ● |
| KEEWAY | | | | | |
| TX | 50 | SM | 10 - | 1 | ● |
| MALAGUTI | | | | | |
| XSM | 50 | | 04 - | 1 | ● |
| | 50 | Fifty | 04 - | 1 | ● |
| CH | 50 | | 86 - | 1 | ● |
| | 125 | Madison | 99 - | 1 | ● |
| | 125 | Phantom Max | 04 - | 1 | ● |
| | 150 | Madison | 99 - | 1 | ● |
| | 180 | Madison | 02 - | 1 | ● |
| | 200 | Madison | 03 - | 1 | ● |
| | 200 | Phantom Max | 04 - | 1 | ● |
| | 250 | Madison ie | 06 - | 1 | ● |
| | 250 | Madison RS | 04 - 07 | 1 | ● |
| | 250 | Password | 05 - | 1 | ● |
| | 250 | Phantom Max | 04 - 08 | 1 | ● |
| MBK | | | | | |
| | 50 | X-Limit Supermotard | 04 - | 1 | ● |
| | 50 | X-Power | 04 - | 1 | ● |
| MH (MOTORHISPANIA) | | | | | |
| MH | 50 | Urban Bike | 06 - | 1 | ● |

| PEUGEOT | | | | | |
|---------|-----|-------------------------------------|---------|---|---|
| XP S6 | 50 | Street / Super Motard | 04 - | 1 | ● |
| XPS | 50 | Street / Top Road | 03 - 09 | 1 | ● |
| XPS | 50 | Super Motard | 03 - 10 | 1 | ● |
| | 125 | Elyseo | 03 - | 1 | ● |
| | 125 | Elystar | 03 - | 1 | ● |
| | 125 | Geopolis | 06 - | 1 | ● |
| | 125 | Jet Force / Compressor | 03 - | 1 | ● |
| | 125 | LXR | 10 - | 1 | ● |
| | 125 | Satelis | 06 - 09 | 1 | ● |
| | 125 | Satelis Compressor | 06 - 10 | 1 | ● |
| | 125 | Satelis RS | 07 - 10 | 1 | ● |
| | 150 | Elyseo | 01 - | 1 | ● |
| | 150 | Elystar | 03 - | 1 | ● |
| | 200 | LXR | 10 - | 1 | ● |
| | 250 | Geopolis (AJP Caliper) / ABS | 06 - 09 | 1 | ● |
| | 250 | Satelis (AJP Caliper) | 07 - 10 | 1 | ● |
| | 400 | Geopolis (AJP Caliper) | 07 - 10 | 1 | ● |
| PIAGGIO | | | | | |
| | 125 | Beverly (Grimeca Caliper) | 02 - 06 | 1 | ● |
| LX | 125 | Hexagon | 98 - 99 | 1 | ● |
| LX4 | 125 | Hexagon | 98 - 99 | 1 | ● |
| LX | 125 | Skipper / ST | 99 - | 1 | ● |
| GTX | 125 | Super Hexagon (Grimeca Caliper) 11' | 00 - | 1 | ● |
| LXT | 180 | Hexagon | 99 - | 1 | ● |
| GTX | 180 | Super Hexagon (Grimeca Caliper) 11' | 00 - | 1 | ● |
| LX | 180 | | 98 - 99 | 1 | ● |
| | 200 | Beverly (Grimeca Caliper) | 02 - 06 | 1 | ● |
| LXT | 200 | | 98 - | 1 | ● |
| BV | 200 | | 05 - | 1 | ● |
| GT | 250 | Hexagon | 99 - | 1 | ● |
| LX4 | 250 | Hexagone | 98 - 99 | 1 | ● |
| GTX | 250 | Super Hexagon | 01 - | 1 | ● |
| RIEJU | | | | | |
| RS2 | 50 | NKD | 05 | 1 | ● |
| RS2 | 50 | Pro (AJP Caliper) | 06 - 10 | 1 | ● |
| MRX | 50 | Pro / Top | 04 - 08 | 1 | ● |
| SMX | 50 | Pro Street (Cast Wheel) | 06 - 08 | 1 | ● |
| SMX | 50 | Pro Supermotard / Top | 04 - 07 | 1 | ● |
| SHERCO | | | | | |
| | 50 | SM 0.5 Black Panther | 08 - 10 | 1 | ● |
| YAMAHA | | | | | |
| DT | 50 | X Supermotard | 04 - | 1 | ● |
| TZR | 50 | | 03 - 08 | 1 | ● |

SCOOTER MAXI-SCOOTER

MSC

Dim./Size

← 99,8 mm
↑ 31 mm
H 9 mm

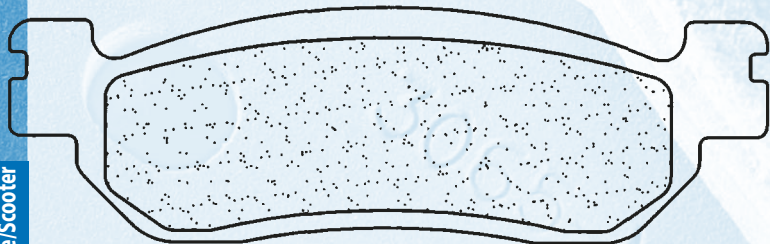

| ITALJET | | | | | |
|---------|-----|------------------|---------|---|---|
| | 125 | Jupiter | 02 - | | ● |
| | 150 | Jupiter | 02 - | | ● |
| MBK | | | | | |
| | 125 | Cityliner | 08 - | | ● |
| | 250 | Skyliner | 99 - 02 | | ● |
| YAMAHA | | | | | |
| RZ | 50 | (5FC1/2) | 02 - | 1 | ● |
| YP | 250 | Majesty | 99 - 03 | | ● |
| YP | 250 | Majesty DX / ABS | 98 - 99 | | ● |
| YP | 250 | R X-Max | 05 - 09 | | ● |
| YP | 250 | R X-Max | 10 - | | ● |
| VP | 250 | X-City | 07 - | | ● |

3033

SCOOTER MAXI-SCOOTER

SC

Dim./Size

← 31,6 mm
↑ 52 mm
H 5,5 mm

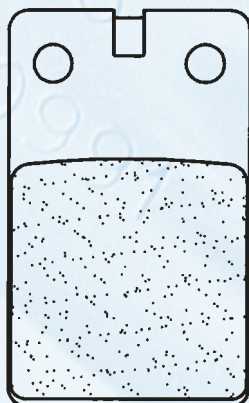

| APRILIA | | | | | |
|----------|----|-----------------------|---------|---|---|
| | 50 | Red Rose | 88 - 89 | 1 | ● |
| GILERA | | | | | |
| | 50 | 503 | 91 - | 1 | ● |
| | 50 | Bullit | 90 - | 1 | ● |
| R | 50 | | 96 - | 1 | ● |
| MALAGUTI | | | | | |
| CR 1 | 50 | Crosser | 95 - | 1 | ● |
| | 50 | Fifty Full / CX / Top | 85 - | 1 | ● |
| | 50 | Fifty Mistral | 90 - | 1 | ● |
| F-15 | 50 | Fire Fox | 96 - 99 | 1 | ● |
| F-12 | 50 | Phantom | 94 - 98 | 1 | ● |
| RST | 50 | Sport | 87 - | 1 | ● |

3034

SCOOTER MAXI-SCOOTER

SC

Dim./Size

← 96,6 mm
↑ 42 mm
H 8,3 mm

Dim./Size

← 77 mm
↑ 42 mm
H 8,3 mm

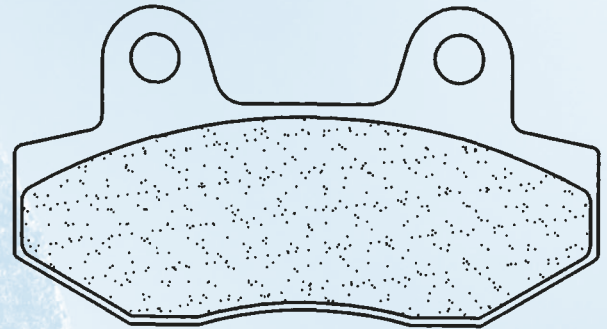
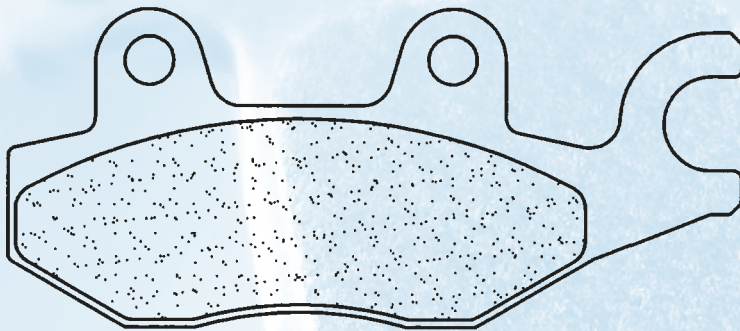

3036

MBK

| | | | | |
|---------------|---------|---------|---|---|
| 50 | X-Power | 98 - 03 | 1 | ● |
| YAMAHA | | | | |
| 50 | R | 94 - | 1 | ● |
| 50 | | 90 - 92 | 1 | ● |
| 50 | | 93 - 02 | 1 | ● |

SCOOTER MAXI-SCOOTER

SC

MSC

3037

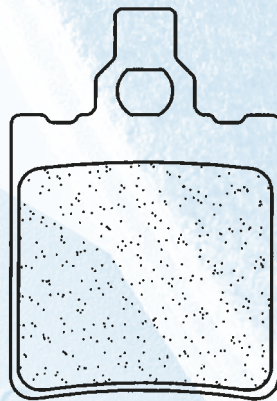

Dim./Size

← 35,3 mm
↑ 51,5 mm
H 6 mm

APRILIA

| | | | | |
|------|----|-----------------|---------|---|
| AF-1 | 50 | AE | 86 - | ● |
| AF-1 | 50 | Europa / Futura | 90 - | ● |
| | 50 | MX | 03 - | ● |
| | 50 | RS | 96 - 99 | ● |
| | 50 | RS / RS Replica | 00 - 05 | ● |
| | 50 | RS Tuono | 03 - | ● |
| | 50 | RX | 90 - | ● |
| | 50 | RX Racing | 04 - | ● |
| | 50 | Tuareg | 86 - | ● |
| | 50 | Tuareg Rally | 90 - | ● |
| 125 | | Léonardo | 96 | ● |

FANTIC

| | | | |
|----|-------|------|---|
| 50 | Oasis | 90 - | ● |
|----|-------|------|---|

KEEWAY

| | | | | |
|----|----|----|------|---|
| TX | 50 | SM | 10 - | ● |
|----|----|----|------|---|

KYMCO

| | | | | |
|-----|---------|---------|---|---|
| 125 | Freeway | 93 - 95 | 1 | ● |
|-----|---------|---------|---|---|

MALAGUTI

| | | | | | | |
|----|----|-----------|------|---|---|---|
| ES | 50 | Dune | 89 - | 1 | ● | ● |
| | 50 | Evolution | 91 - | 1 | ● | ● |

CAGIVA

| | | | | |
|----|------|---------|---|---|
| 50 | City | 92 - 94 | 1 | ● |
|----|------|---------|---|---|

DAELIM

| | | | | |
|----|-----------|------|---|---|
| 50 | Bonita | 09 - | 1 | ● |
| | G Message | 98 - | 1 | ● |
| | S-Five | 06 - | 1 | ● |

GARELLI

| | | | | |
|-----|---------|------|---|---|
| 125 | Panther | 02 - | 1 | ● |
| 150 | Panther | 02 - | 1 | ● |
| 250 | Panther | 02 - | 1 | ● |

HONDA

| | | | | | |
|-----|----|-----------------|---------|---|---|
| GP | 50 | Dio | 89 - | 1 | ● |
| SR | 50 | Dio | 93 - | 1 | ● |
| | 50 | Giorno | 92 - | 1 | ● |
| | 50 | Jazz | 92 - | 1 | ● |
| ZX | 50 | Super Dio | 92 - | 1 | ● |
| SR | 50 | Super Dio | 91 - 92 | 1 | ● |
| | 50 | Tact S | 93 - | 1 | ● |
| HSC | 50 | ZR / 01 Scooter | 92 - | 1 | ● |
| SP | 50 | | 92 - | 1 | ● |

SYM

| | | | | | |
|--|-----|-------------|---------|---|---|
| | 50 | City Hopper | 99 - 02 | 1 | ● |
| | 50 | Orbit | 08 - 09 | 1 | ● |
| | 50 | Super Fancy | 98 - | 1 | ● |
| | 125 | Orbit | 08 - 09 | 1 | ● |

SCOOTER MAXI-SCOOTER

SC

MSC

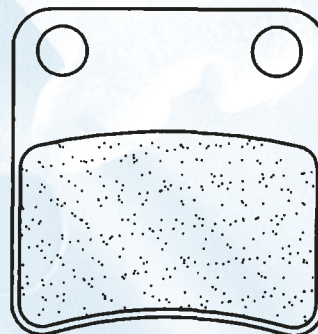

Dim./Size

← 40,9 mm
↑ 42,7 mm
H 8 mm

3038

SCOOTER

MAXI-SCOOTER

SC

MSC

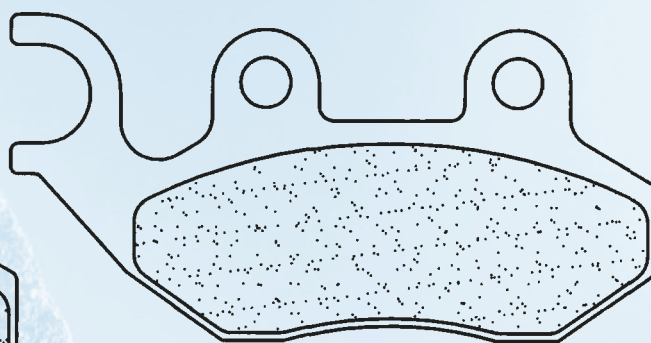

Dim./Size

69,8 mm

41 mm

8,2 mm

Dim./Size

85 mm

42,9 mm

8,2 mm

3039

| CAGIVA | | | | |
|---------|----------------------|---------|---|---|
| 50 | City | 95 - | 1 | ● |
| GARELLI | | | | |
| PMX | 50 Sport | 00 - | 1 | ● |
| KRS | 50 | 02 - | 1 | ● |
| 125 | Freeland | 02 - | 1 | ● |
| 125 | T-Rex | 00 - | 1 | ● |
| 150 | Freeland | 02 - | 1 | ● |
| PEUGEOT | | | | |
| 50 | Tweet (4T) | 10 - | 1 | ● |
| 125 | Tweet | 10 - | 1 | ● |
| 150 | Tweet | 10 - | 1 | ● |
| PGO | | | | |
| 50 | Dr. Big | 01 - | 1 | ● |
| 50 | G-max | 06 - | 1 | ● |
| 50 | Libra | 10 - | 1 | ● |
| 50 | Ligero | 06 - | 1 | ● |
| PMX | 50 Naked | 06 - | 1 | ● |
| PMX | 50 Sport | 01 - | 1 | ● |
| 50 | T-Rex | 99 - | 1 | ● |
| PMS | | | | |
| 50 | My Bubu | 02 - | 1 | ● |
| 110 | T-Rex | 99 - | 1 | ● |
| 125 | Charge A / B | 02 - | 1 | ● |
| 125 | Ligero | 06 - | 1 | ● |
| 125 | My Bubu / Young Bubu | 02 - | 1 | ● |
| 125 | T Rex | 99 - | 1 | ● |
| 150 | TR3 | 02 - | 1 | ● |
| 150 | T-Rex | 01 - | 1 | ● |
| | i-Dep (Electric) | 09 - | 1 | ● |
| SYM | | | | |
| 50 | Fiddle II | 08 - 10 | 1 | ● |
| 50 | Jet 4 (4T) | 10 - | 1 | ● |
| 50 | Jet Alpha | 95 - | 1 | ● |
| 50 | Jet BasiX | 06 - 09 | 1 | ● |
| 50 | Jet Euro X | 06 - | 1 | ● |
| 50 | Jet Euro X S | 99 - 05 | 1 | ● |

| SYM | | | | |
|-----|--------------------------------|---------|---|---|
| 50 | Jet Sport X SR | 06 - | 1 | ● |
| 50 | Jungle | 96 - | 1 | ● |
| 50 | Mask / Mask LC | 00 - 05 | 1 | ● |
| 50 | Red Devil | 99 - 09 | 1 | ● |
| 50 | Super Fancy | 95 - 97 | 1 | ● |
| 50 | Symphony (4T) | 09 - | 1 | ● |
| 50 | Symply | 07 - | 1 | ● |
| 100 | Jet | 99 - 00 | 1 | ● |
| 100 | Jet Euro X | 05 - | 1 | ● |
| 100 | Jet Sport X | 06 - | 1 | ● |
| 100 | Party | 97 - | 1 | ● |
| 100 | Super Fancy | 95 - | 1 | ● |
| 110 | Star | 03 - | 1 | ● |
| 125 | Attila | 95 - | 1 | ● |
| 125 | Citycom | 08 - | 1 | ● |
| HD | | | | |
| 125 | Evo i | 07 - 10 | 1 | ● |
| 125 | Fiddle II | 08 - | 1 | ● |
| 125 | Jet 4 (4T) | 10 - | 1 | ● |
| 125 | Megalo | 00 - 07 | 1 | ● |
| 125 | New Duke | 02 - | 1 | ● |
| HD | | | | |
| 125 | S Evo | 07 - | 1 | ● |
| 125 | Super Duke | 99 - 02 | 1 | ● |
| 125 | Symphony (4T) | 09 - | 1 | ● |
| 125 | Symply | 07 - 09 | 1 | ● |
| 150 | Attila | 00 - | 1 | ● |
| 150 | Super Duke | 99 - 02 | 1 | ● |
| HO1 | | | | |
| 150 | HD Evo | 95 - | 1 | ● |
| 200 | HD Evo i | 07 - | 1 | ● |
| 200 | HD Evo i | 07 - 09 | 1 | ● |
| GTS | | | | |
| 300 | Citycom i | 08 - 09 | 2 | ● |
| TGB | | | | |
| 50 | 101 R | 04 - 09 | 1 | ● |
| 50 | 202 Classic | 03 - 09 | 1 | ● |
| 50 | Akros Tec | 03 - 04 | 1 | ● |
| 50 | Delivery (Up to E/F no 609099) | 04 - 06 | 1 | ● |

SCOOTER

MAXI-SCOOTER

SC

MSC

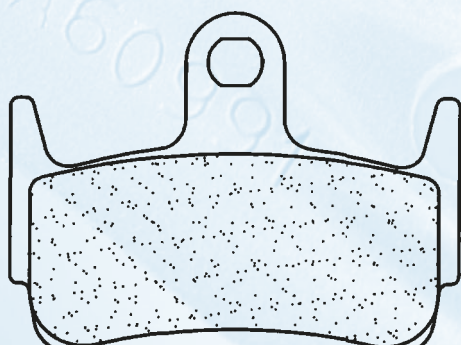

Dim./Size

58,8 mm

44,5 mm

9,5 mm

| HONDA | | | | |
|-------|-------------------|------|--|---|
| SZX | 50 X8R-S / X8R-X | 98 - | | ● |
| KYMCO | | | | |
| DD | 50 Sniper | 94 - | | ● |
| | 150 Heroism | 95 - | | ● |
| SYM | | | | |
| | 50 Jet Sport X SR | 06 - | | ● |

3041

SCOOTER MAXI-SCOOTER

SC MSC

3043

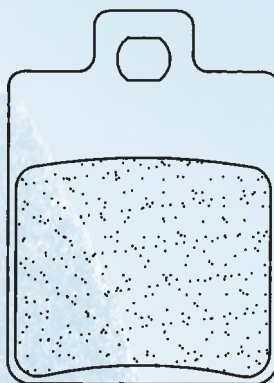

Dim./Size
← 35,5 mm
↑ ↓ 49 mm
H 6,9 mm

GILERA

| | | | | |
|----------------|-----|------------------------------|-----------|---|
| DNA | 50 | (Grimeca Caliper) | 00 - | ● |
| DNA | 50 | (Hengtong Caliper) | 00 - | ● |
| | 50 | Runner | 98 - 05 | ● |
| | 50 | Runner PJ | 06 - | ● |
| | 50 | Runner SP | 01 - 05 | ● |
| | 50 | Runner SP | 06 - | ● |
| | 50 | Stalker | 97 - | ● |
| FX | 125 | Runner/SP (Grimeca Caliper) | 00 - | ● |
| FX | 125 | Runner/SP (Hengtong Caliper) | 00 - | ● |
| FXR | 180 | Runner/SP (Grimeca Caliper) | 00 - | ● |
| FXR | 180 | Runner/SP (Hengtong Caliper) | 00 - | ● |
| FX | 200 | Runner SP | 98 - | ● |
| | 200 | Stalker | 97 - | ● |
| RC | 500 | Fuoco ie | 08 - 2 | ● |
| PIAGGIO | | | | |
| S | 50 | 2T | 07 - 1 | ● |
| LX | 50 | 2T / 4T | 05 - 1 | ● |
| S | 50 | 4T | 09 - 1 | ● |
| NRG | 50 | Extreme | 01 - | ● |
| | 50 | Liberty | 97 - 1 | ● |
| | 50 | Liberty 4T | 00 - 1 | ● |
| NRG | 50 | MC 2 | 98 - 02 | ● |
| | 50 | Zip Fast Rider | 96 - 1 | ● |
| | 50 | Zip RST | 96 - 99 1 | ● |
| | 50 | Zip SP / Disco | 96 - 1 | ● |
| ET2 | 50 | | 97 - 01 1 | ● |
| ET2 | 50 | | 02 - 1 | ● |
| ET4 | 50 | | 00 - 1 | ● |
| LX | 125 | 4T | 05 - 1 | ● |
| S | 125 | 4T | 07 - 1 | ● |
| LE | 125 | Liberty / S | 98 - 10 1 | ● |
| | 125 | MP3 | 06 - 08 2 | ● |
| | 125 | MP3 Hybrid | 09 - 10 2 | ● |
| | 125 | MP3 ie | 08 - 10 2 | ● |
| | 125 | Sfera | 95 - 1 | ● |

PIAGGIO

| | | | | |
|--------------|-----|--------------|-----------|---|
| ET4 | 125 | Vespa | 96 - 1 | ● |
| | 125 | Zip II 4T | 00 - 1 | ● |
| PX | 125 | | 02 - 1 | ● |
| | 150 | Liberty | 99 - 09 1 | ● |
| ET4 | 150 | | 02 - 1 | ● |
| PX | 150 | | 02 - 1 | ● |
| | 200 | Liberty | 06 - 1 | ● |
| PX | 200 | | 02 - 1 | ● |
| | 250 | LX 60 | 06 - 1 | ● |
| | 250 | MP3 ie / LT | 06 - 09 2 | ● |
| | 300 | MP3 LT | 10 - 2 | ● |
| | 400 | MP3 ie | 07 - 2 | ● |
| | 400 | MP3 LT | 09 - 2 | ● |
| | 500 | MP3 ie | 09 - 10 2 | ● |
| SACHS | | | | |
| | 125 | Speedjet RS | 10 | ● |
| | 400 | Quattrocento | 08 | ● |

SCOOTER MAXI-SCOOTER

SC MSC

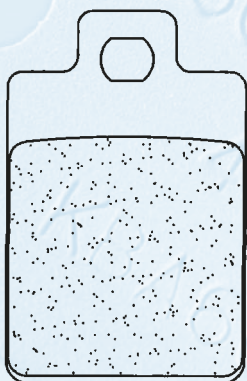

Dim./Size
← 31,5 mm
↑ ↓ 49 mm
H 7 mm

3045

GILERA

| | | | | |
|----------------|-----|---------------|-----------|---|
| | 50 | Easy moving | 96 - 1 | ● |
| | 50 | Typhoon | 96 - 1 | ● |
| | 125 | Typhoon | 96 - 1 | ● |
| PIAGGIO | | | | |
| | 25 | Zip II Cat DT | 01 - 1 | ● |
| | 50 | Free | 93 - 96 1 | ● |
| | 50 | Sfera RST | 95 - 1 | ● |
| | 50 | Storm | 96 - 1 | ● |
| | 50 | Typhoon | 96 - 1 | ● |
| | 50 | Zip II | 01 - 1 | ● |
| | 50 | Zip II Cat DT | 01 - 1 | ● |
| NTT | 50 | | 96 - 1 | ● |
| TPH | 50 | | 96 - 1 | ● |
| | 80 | Skipper | 96 - 1 | ● |
| | 80 | Typhoon | 96 - 1 | ● |
| | 125 | Hexagon | 96 - 97 1 | ● |
| | 125 | Skipper | 96 - 98 1 | ● |
| | 125 | Typhoon | 96 - 1 | ● |
| TPH | 125 | | 96 - 1 | ● |
| | 150 | Hexagon | 96 - 97 1 | ● |

SCOOTER MAXI-SCOOTER

SC MSC

3047

Dim./Size

60 mm

44 mm

9,2 mm

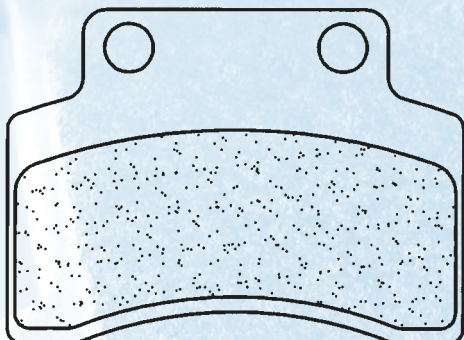

CAGIVA

| | | | | |
|-----|--------|------|---|---|
| 50 | Nag | 08 - | 1 | ● |
| 125 | Brillo | 08 - | 1 | ● |

CPI

| | | | | |
|-----|-----------|------|---|---|
| 50 | Aragon GP | 06 - | 1 | ● |
| 50 | Freaky | 07 - | 1 | ● |
| 50 | Hussar | 03 - | 1 | ● |
| 50 | Olivier | 03 - | 1 | ● |
| 50 | Popcorn | 03 - | 1 | ● |
| 125 | Aragon GP | 07 - | 1 | ● |

GENERIC

| | | | | |
|-----|--------|------|---|---|
| 50 | Ideo | 06 - | 1 | ● |
| 50 | Roc | 08 - | 1 | ● |
| 50 | Stroke | 08 - | 1 | ● |
| 50 | XOR | 06 - | 1 | ● |
| 125 | Soho | 07 - | 1 | ● |
| 125 | Stroke | 08 - | 1 | ● |
| 125 | XOR | 07 - | 1 | ● |
| 125 | Zion | 08 - | 1 | ● |

ITALJET

| | | | | | |
|---------------|-----|---------------------|---------|---|---|
| SX1 | 50 | | 08 - | 1 | ● |
| KEEWAY | | | | | |
| | 50 | F-Act | 07 - | 1 | ● |
| | 50 | Flash Electric | 10 - | 1 | ● |
| | 50 | Focus | 06 - | 1 | ● |
| | 50 | Matrix | 06 - | 1 | ● |
| | 50 | Matrix Electric | 10 - | 1 | ● |
| | 50 | Matrix Racing Sport | 10 - | 1 | ● |
| F-NKD | 50 | | 10 - | 1 | ● |
| RY8 | 50 | | 07 - 09 | 1 | ● |
| RY8 | 50 | | 10 - | 1 | ● |
| | 125 | Focus | 06 - | 1 | ● |
| | 125 | Matrix | 07 - 10 | 1 | ● |
| | 125 | Matrix Racing Sport | 10 - | 1 | ● |
| | 150 | Focus | 06 - | 1 | ● |
| | 150 | Matrix | 06 - | 1 | ● |
| | 150 | Matrix Racing Sport | 10 - | 1 | ● |

KYMCO

| | | | | | |
|--|-----|---------|------|---|---|
| | 50 | Calypso | 97 - | 1 | ● |
| | 50 | Heroism | 97 - | 1 | ● |
| | 125 | Calypso | 99 - | 1 | ● |
| | 125 | Heroism | 95 - | 1 | ● |
| | 150 | Heroism | 95 - | 1 | ● |

PEUGEOT

| | | | | | |
|----|----|-----------------------|---------|---|---|
| SV | 50 | Executive | 95 - | 1 | ● |
| | 50 | New Vivacity 2T / 4T | 08 - 10 | 1 | ● |
| SV | 80 | | 95 - | 1 | ● |
| | | E-Vivacity (Electric) | 10 - | 1 | ● |

RIEJU

| | | | | | |
|--|-----|-----------------|---------|---|---|
| | 50 | Pacific (4T) | 08 | 1 | ● |
| | 50 | Toreo (4T) | 07 - 08 | 1 | ● |
| | 125 | Pacific (4T) | 08 | 1 | ● |
| | 125 | Pacific Scooter | 09 | 1 | ● |

SACHS

| | | | | | |
|--|-----|-------------|---------|---|---|
| | 50 | 49ER 12 | 08 | 1 | ● |
| | 50 | Speedforce | 08 | 1 | ● |
| | 50 | Speedjet | 08 | 1 | ● |
| | 50 | SX-1 (2T) | 08 - 09 | 1 | ● |
| | 125 | Speedjet RS | 10 | 1 | ● |

SCOOTER MAXI-SCOOTER

MSC

3049

DAELIM

| | | | | |
|-----|--------|------|---|---|
| 125 | Otello | 08 - | 1 | ● |
| 125 | S2 FI | 07 - | 1 | ● |
| 125 | U3 FI | 07 - | 1 | ● |

KAWASAKI

| | | | | | |
|----|-----|---------|------|---|---|
| SC | 250 | Epsilon | 02 - | 1 | ● |
|----|-----|---------|------|---|---|

SUZUKI

| | | | | | |
|----|-----|-------------------|---------|---|---|
| AN | 250 | Burgman / Skywave | 98 - 03 | 1 | ● |
| AN | 250 | Burgman / Skywave | 04 - 06 | 1 | ● |
| AN | 400 | Burgman / Skywave | 99 - 00 | 1 | ● |
| AN | 400 | Burgman / Skywave | 01 - 06 | 1 | ● |

SYM

| | | | | | |
|----|-----|--|------|---|---|
| GT | 500 | | 04 - | 2 | ● |
|----|-----|--|------|---|---|

Dim./Size

44,8 mm

53,6 mm

8,7 mm

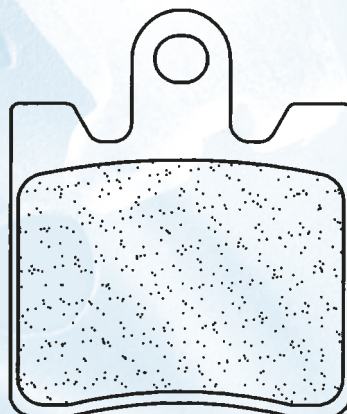

SCOOTER MAXI-SCOOTER

SC MSC

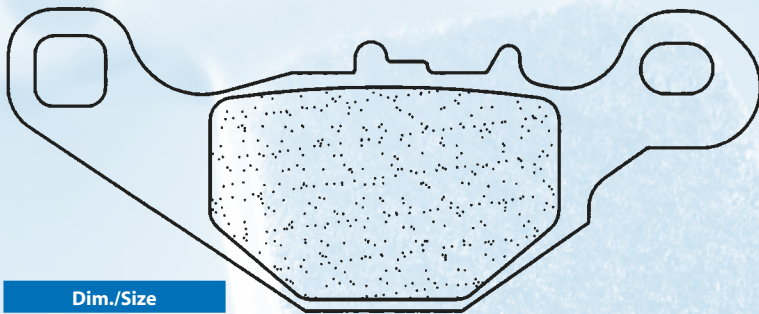

Dim./Size
→ 99,2 mm
↑ 39,7 mm
H 7,5 mm

3051

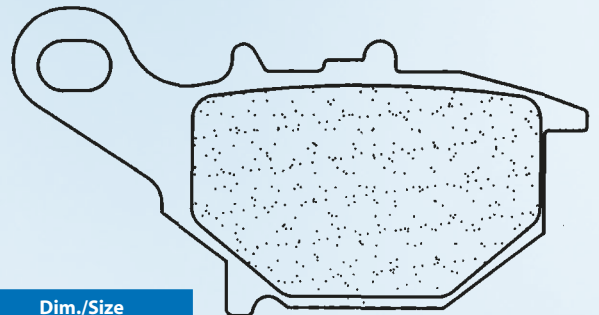

Dim./Size
→ 75,7 mm
↑ 40,6 mm
H 8,2 mm

SUZUKI

| | | | | | |
|----|-----|------------------------------|---------|---|---|
| AZ | 50 | RY / RK2 | 00 - 02 | 1 | ● |
| TR | 50 | Street Magic | 98 - | 1 | ● |
| AN | 50 | | 95 | 1 | ● |
| UG | 110 | W/SW/Y/SY/SK1 Hokuto/Address | 98 - 02 | 1 | ● |
| UZ | 125 | (CF46A) V125G | 05 - | 1 | ● |
| UC | 125 | Epicuro | 99 - 02 | 1 | ● |
| AN | 125 | R / Vecstar | 94 - | 1 | ● |
| AN | 125 | S / T / V / W / X | 95 - 00 | 1 | ● |
| AN | 150 | | 98 - | 1 | ● |
| UC | 150 | Epicuro | 99 - | 1 | ● |
| AN | 250 | Vecstar | 94 - | 1 | ● |

SCOOTER MAXI-SCOOTER

SC MSC

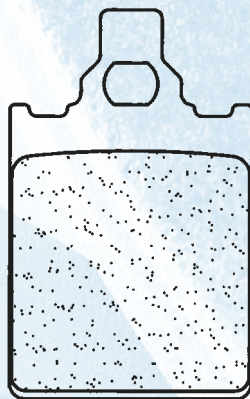

3053

Dim./Size
→ 31,5 mm
↑ 51 mm
H 5,5 mm

APRILIA

| | | | | |
|-----|------------|---------|---|---|
| 50 | SR Replica | 94 - | 1 | ● |
| 50 | Quartz | 92 - | 1 | ● |
| 80 | Skipper | 93 - 95 | 1 | ● |
| PX | 125 | 99 - 01 | 1 | ● |
| 125 | Skipper | 93 - 95 | 1 | ● |
| 150 | Skipper | 94 - | 1 | ● |

BENELLI

| | | | |
|-----|-------|------|---|
| 125 | Adiva | 00 - | ● |
| 150 | Adiva | 00 - | ● |

GILERA

| | | | | |
|-----|-----|------------------------------|------|---|
| ST | 125 | Runner | 08 - | ● |
| VX | 125 | Runner 4T (Grimeca Caliper) | 01 - | ● |
| VX | 125 | Runner 4T (Hengtong Caliper) | 01 - | ● |
| VXR | 180 | Runner 4T (Grimeca Caliper) | 01 - | ● |
| VXR | 180 | Runner 4T (Hengtong Caliper) | 01 - | ● |
| ST | 200 | Runner | 08 - | ● |
| VXR | 200 | Runner 4T (Grimeca Caliper) | 01 - | ● |
| VXR | 200 | Runner 4T (Hengtong Caliper) | 01 - | ● |

PIAGGIO

| | | | | |
|-----|-----|--------------------------------------|------|---|
| GT | 125 | L | 04 - | ● |
| GTX | 125 | Super Hexagon (Grimeca Caliper) 11' | 00 - | ● |
| GTX | 125 | Super Hexagon (Hengtong Caliper) 11' | 00 - | ● |
| GTX | 125 | Super Hexagon (Hengtong Caliper) 12' | 00 - | ● |
| GTS | 125 | 07 - | ● | ● |
| GTX | 180 | Super Hexagon (Grimeca Caliper) 11' | 00 - | ● |
| GTX | 180 | Super Hexagon (Hengtong Caliper) 11' | 00 - | ● |
| GTX | 180 | Super Hexagon (Hengtong Caliper) 12' | 01 - | ● |
| GT | 200 | L | 04 - | ● |
| GTS | 250 | ABS | 06 - | ● |
| GTX | 250 | Super Hexagon | 01 - | ● |
| GTS | 300 | Super | 09 - | ● |

SCOOTER MAXI-SCOOTER

MSC

3054

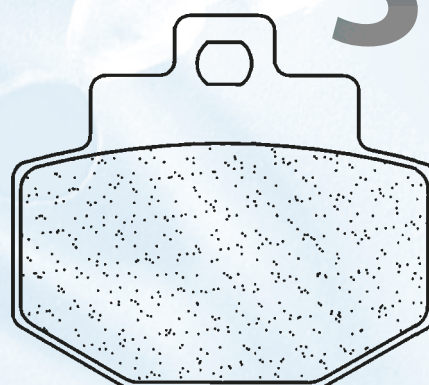

Dim./Size
→ 55,4 mm
↑ 49,3 mm
H 7 mm

APRILIA

| | | | |
|-----|----------------------------|---------|---|
| 50 | Scarabeo Ditech | 02 - | ● |
| 50 | SR Ditech / Racing | 00 - | ● |
| 50 | SR Street | 05 - | ● |
| 125 | Atlantic | 03 - | ● |
| 125 | Scarabéo / Scarabéo GT | 99 - 03 | ● |
| 125 | Scarabéo / Scarabéo GT | 04 - | ● |
| 125 | Sportcity | 05 - | ● |
| 150 | Scarabeo | 99 - 03 | ● |
| 150 | Scarabeo | 04 - | ● |
| 200 | Atlantic | 03 - | ● |
| 200 | Scarabéo | 07 - | ● |
| 200 | Scarabéo / Scarabéo GT | 02 - 03 | ● |
| 200 | Scarabéo Class | 10 - | ● |
| 200 | Sportcity | 05 - | ● |
| 250 | Atlantic ie | 07 - | ● |
| 250 | Léonardo | 99 - 01 | ● |
| 250 | Léonardo | 02 - | ● |
| 250 | Léonardo (Grimeca Caliper) | 99 - | ● |
| 250 | Scarabéo / Scarabéo ie | 06 - | ● |
| 250 | Sportcity ie | 07 - | ● |
| 300 | Scarabéo Special | 10 - | ● |
| 400 | Scarabéo ie | 07 - | ● |
| 500 | Atlantic | 02 - 05 | ● |
| 500 | Atlantic Sprint | 06 - | ● |
| 500 | Scarabéo | 03 - 09 | ● |
| 500 | Scarabéo Class | 10 - | ● |

BETA

| | | | |
|-----|-------|------|---|
| 50 | Eikon | 04 - | ● |
| 125 | Eikon | 04 - | ● |
| 150 | Eikon | 04 - | ● |

MALAGUTI

| | | | |
|-----|-------------|------|---|
| 125 | F-18 | 00 - | ● |
| 125 | Madison | 99 - | ● |
| 125 | Phantom Max | 04 - | ● |
| 150 | Madison | 99 - | ● |
| 180 | Madison | 02 - | ● |
| 200 | Madison | 03 - | ● |

SCOOTER

MAXI-SCOOTER

SC

MSC

Dim./Size

→ **50,8 mm**
↑ **53,5 mm**
H **9,3 mm**

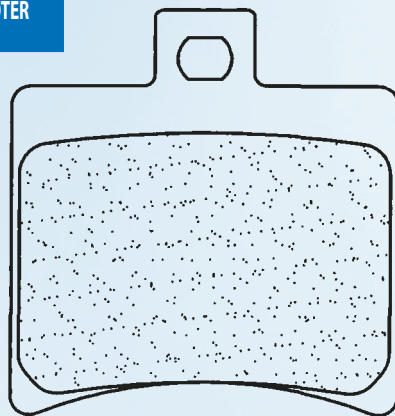

3055

MALAGUTI

| | | | |
|-----|--------------|---------|---|
| 200 | Phantom Max | 04 - | ● |
| 250 | Madison ie | 06 - | ● |
| 250 | Madison RS | 04 - 07 | ● |
| 250 | Madison S | 99 - 03 | ● |
| 250 | Password | 05 - | ● |
| 250 | Phantom Max | 04 - 08 | ● |
| 400 | Madison K | 02 - 06 | ● |
| 500 | Spidermax GT | 04 - | ● |
| 500 | Spidermax RS | 09 - | ● |

PEUGEOT

| | | | |
|-----|----------|------|---|
| 125 | Citystar | 11 - | ● |
|-----|----------|------|---|

SCOOTER

MAXI-SCOOTER

MSC

3056

Dim./Size

→ **117,3 mm**
↑ **40 mm**
H **8,4 mm**

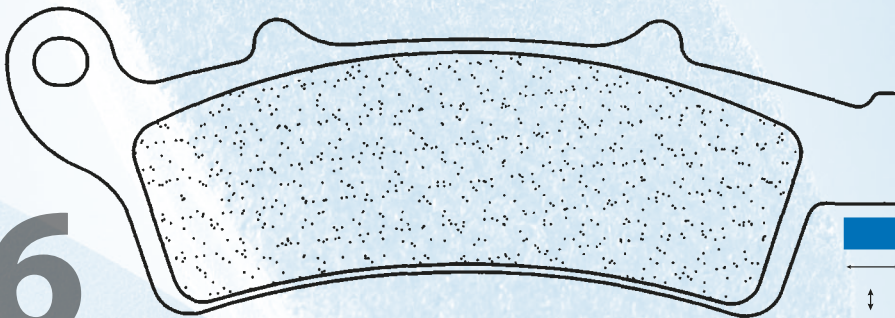

APRILIA

| | | | | |
|-----|------------------------|------|---|---|
| 125 | Atlantic | 03 - | 1 | ● |
| 125 | Scarabéo / Scarabéo GT | 04 - | 1 | ● |
| 150 | Scarabeo | 04 - | 1 | ● |
| 200 | Atlantic | 03 - | 1 | ● |
| 200 | Scarabéo | 07 - | 1 | ● |
| 200 | Scarabéo Class | 10 - | 1 | ● |
| 250 | Atlantic ie | 07 - | 1 | ● |
| 250 | Léonardo | 02 - | 1 | ● |
| 250 | Scarabéo / Scarabéo ie | 06 - | 1 | ● |

APRILIA

| | | | | |
|-----|------------------|------|---|---|
| 300 | Scarabéo Special | 10 - | 1 | ● |
| 500 | Atlantic Sprint | 06 - | 1 | ● |

MALAGUTI

| | | | | |
|-----|-----------|---------|---|---|
| 250 | Madison S | 99 - 03 | 1 | ● |
| 400 | Madison K | 02 - 06 | 1 | ● |

PEUGEOT

| | | | | |
|-----|--------|---------|---|---|
| 125 | Looxor | 03 - 08 | 1 | ● |
| 150 | Looxor | 03 - | 1 | ● |

SCOOTER

MAXI-SCOOTER

SC

MSC

Dim./Size

→ **50,7 mm**
↑ **53,8 mm**
H **7,8 mm**

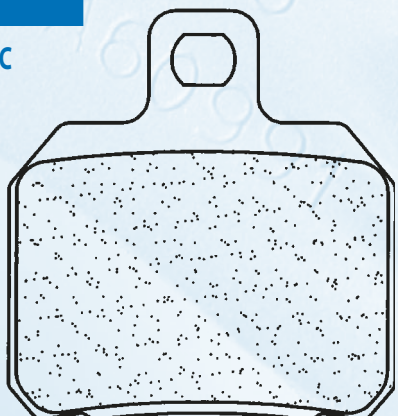

APRILIA

| | | | | |
|-----|---------|------|---|---|
| 50 | RS | 06 - | 1 | ● |
| 50 | GTR | 03 - | 1 | ● |
| 125 | X-large | 02 - | 2 | ● |
| 200 | X-large | 02 - | 2 | ● |

DERBI

| | | | | | |
|-----|-----|--------|------|---|---|
| GPR | 50 | Nude | 05 - | 1 | ● |
| GPR | 50 | Racing | 05 - | 1 | ● |
| GP1 | 50 | | 05 - | 1 | ● |
| | 125 | GP1 | 05 - | 1 | ● |
| | 250 | GP1 | 05 - | 1 | ● |

3057

3057 suite

GILERA

| | | | | |
|-----|-----|--------------------|------|---|
| DNA | 125 | (Grimeca Caliper) | 01 - | ● |
| DNA | 125 | (Hengtong Caliper) | 01 - | ● |
| DNA | 180 | (Grimeca Caliper) | 01 - | ● |
| DNA | 180 | (Hengtong Caliper) | 01 - | ● |
| | 500 | Nexus | 04 - | ● |

MALAGUTI

| | | | | | |
|-----|----|--------|------|---|---|
| NKD | 50 | Drakon | 06 - | 1 | ● |
|-----|----|--------|------|---|---|

MBK

| | | | | |
|--|-----|------------|---------|---|
| | 125 | Skycruiser | 06 - 09 | ● |
| | 125 | Skycruiser | 10 - | ● |
| | 125 | Skyliner | 01 - 10 | ● |
| | 125 | Thunder | 01 - 03 | ● |
| | 150 | Skyliner | 01 - | ● |
| | 150 | Thunder | 01 - 03 | ● |
| | 180 | Skyliner | 04 - | ● |

PEUGEOT

| | | | | |
|--|----|----------------------------|------|---|
| | 50 | Speedfight 3 Liquid Cooled | 09 - | ● |
| | 50 | Speedfight 3 RS | 09 - | ● |

PIAGGIO

| | | | | | |
|--|-----|-------------------------|-----------|---|---|
| | 125 | X8 | 04 | ● | |
| | 125 | X9 | 01 - 03 | 2 | ● |
| | 125 | X9 | 04 - 05 L | ● | |
| | 125 | X9 Evo (Brembo Caliper) | 03 - 04 | 2 | ● |
| | 180 | X9 | 02 - | 2 | ● |
| | 200 | X8 | 04 | ● | |
| | 200 | X9 | 03 - | 2 | ● |
| | 250 | X9 | 00 - 04 | 2 | ● |
| | 400 | Beverly Tourer | 08 - 09 | 1 | ● |
| | 500 | Beverly | 02 - 05 | 2 | ● |
| | 500 | Beverly | 06 | 2 | ● |

PIAGGIO

| | | | | | |
|----|-----|-----------------|---------|---|---|
| | 500 | Beverly Cruiser | 07 - 09 | 2 | ● |
| | 500 | X9 | 00 - 02 | 2 | ● |
| | 500 | X9 Evo | 03 - 06 | ● | |
| | 500 | X9 Evo ABS | 04 - | ● | |
| BV | 500 | | 06 - | 2 | ● |

RIEJU

| | | | | | |
|-----|----|-----------------------------------------|---------|---|---|
| MRT | 50 | Pro (Radial / Double Piston Caliper) | 09 - 10 | 1 | ● |
| MRT | 50 | Supermotard (Radial Caliper/Cast Wheel) | 09 - 10 | 1 | ● |
| | 50 | Tango | 07 - 10 | 1 | ● |

SUZUKI

| | | | | |
|----|-----|---------|---------|---|
| UH | 125 | Burgman | 02 - 06 | ● |
| UH | 150 | Burgman | 04 - 06 | ● |

YAMAHA

| | | | | |
|----|-----|-------------|---------|---|
| YP | 125 | BLACK X-Max | 09 - | ● |
| YP | 125 | Majesty | 01 - 09 | ● |
| XQ | 125 | Maxster | 01 - 03 | ● |
| YP | 125 | R X-Max | 06 - 09 | ● |
| YP | 125 | R X-Max | 10 - | ● |
| VP | 125 | X-City | 08 - | ● |
| YP | 150 | Majesty | 01 - | ● |
| XQ | 150 | Maxter | 01 - | ● |
| YP | 180 | R Majesty | 04 - | ● |

SCOOTER

MAXI-SCOOTER

MSC

YAMAHA

| | | | | | |
|----|-----|---------------|---------|---|---|
| YP | 400 | Majesty | 04 | 1 | ● |
| XP | 500 | T-Max (N/P/R) | 01 - 03 | 1 | ● |

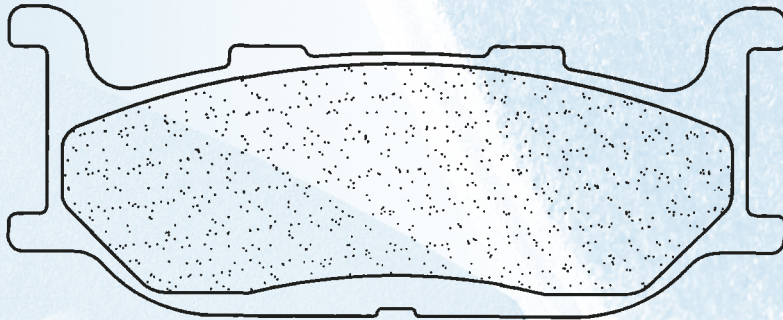

3058

Dim./Size

→ 102,1 mm
↑ 40,9 mm
H 10 mm

SCOOTER

MAXI-SCOOTER

MSC

3059

HONDA

| | | | | |
|-----|-----|-------------------------------|---------|---|
| SWT | 400 | / ABS | 09 - | ● |
| FJS | 400 | Silver Wing | 06 - 08 | ● |
| FJS | 400 | Silver Wing T | 09 - | ● |
| FJS | 600 | Silver Wing / Silver Wing ABS | 01 - | ● |

MBK

| | | | | | |
|--|-----|-----------|------|---|---|
| | 125 | Cityliner | 08 - | 1 | ● |
|--|-----|-----------|------|---|---|

YAMAHA

| | | | | | |
|----|-----|---------|------|---|---|
| VP | 125 | X-City | 08 - | 1 | ● |
| YP | 250 | R X-Max | 10 - | 1 | ● |
| VP | 250 | X-City | 07 - | 1 | ● |
| XC | 300 | Versity | 06 - | 1 | ● |

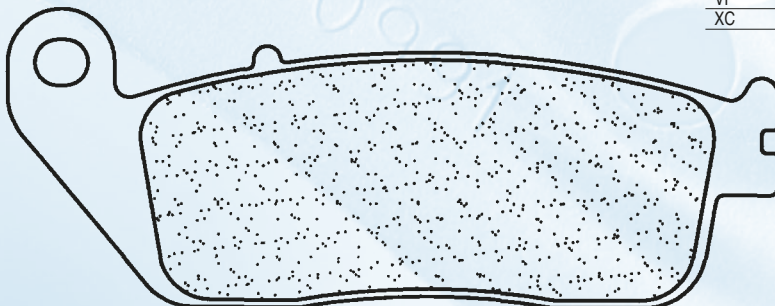

Dim./Size

→ 102 mm
↑ 40 mm
H 9,8 mm

SCOOTER

MAXI-SCOOTER

SC

MSC

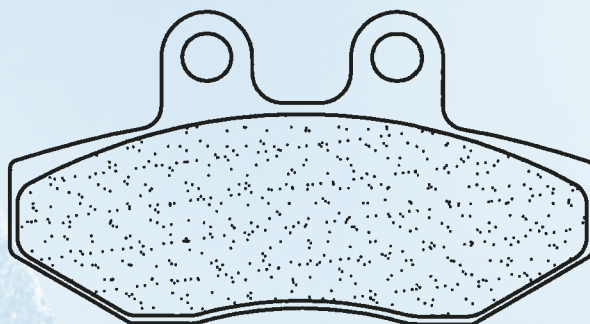
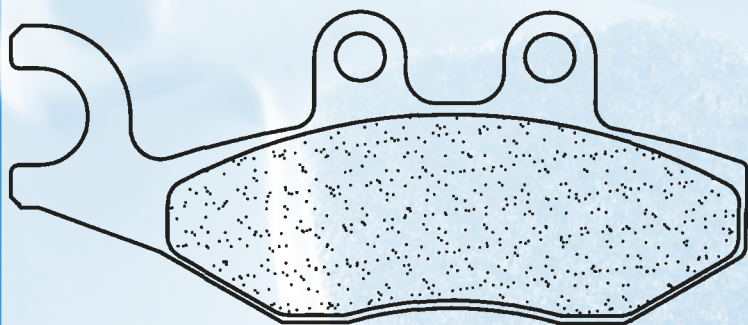

Dim./Size

96,7 mm

41 mm

9 mm

Dim./Size

76,9 mm

41 mm

9 mm

3060

GILERA

| | | | | | | |
|-----|-----|------------------------------|------|---|---|---|
| DNA | 50 | (Hengtong Caliper) | 00 - | 1 | ● | |
| DNA | 125 | (Hengtong Caliper) | 01 - | 1 | ● | |
| FX | 125 | Nexus | 07 - | 2 | ● | ● |
| ST | 125 | Runner | 08 - | 1 | ● | |
| VX | 125 | Runner 4T (Hengtong Caliper) | 01 - | 1 | ● | |
| FX | 125 | Runner/SP (Hengtong Caliper) | 00 - | 1 | ● | |
| DNA | 180 | (Hengtong Caliper) | 01 - | 1 | ● | |
| VXR | 180 | Runner | 01 - | 1 | ● | |
| VXR | 180 | Runner 4T (Hengtong Caliper) | 01 - | 1 | ● | |
| FXR | 180 | Runner/SP (Hengtong Caliper) | 00 - | 1 | ● | |
| ST | 200 | Runner | 08 - | 1 | ● | |
| VXR | 200 | Runner 4T (Hengtong Caliper) | 01 - | 1 | ● | |
| | 250 | Nexus | 07 - | 2 | ● | ● |
| GP | 800 | | 08 - | | | ● |

PEUGEOT

| | | | | | | |
|--|-----|--------------------------|---------|---|---|---|
| | 125 | Citystar | 11 - | 1 | ● | |
| | 250 | Satelis (Nissin Caliper) | 06 - 10 | | | ● |

PIAGGIO

| | | | | | | |
|-----|-----|--------------------------------------|-----------|---|---|---|
| | 50 | Fly | 05 - | 1 | ● | |
| | 100 | Zip | 07 - | 1 | ● | |
| | 125 | Beverly (Hengtong Caliper) | 02 - 06 | 1 | ● | ● |
| | 125 | Beverly / S | 07 - | 1 | ● | ● |
| | 125 | Beverly Tourer | 08 - 09 | 1 | ● | ● |
| | 125 | Carnaby | 07 - 09 | 1 | ● | ● |
| | 125 | Fly | 05 - 09 | 1 | ● | |
| GT | 125 | L | 04 - | 1 | ● | |
| GTX | 125 | Super Hexagon (Hengtong Caliper) 11' | 00 - | 1 | ● | |
| GTX | 125 | Super Hexagon (Hengtong Caliper) 12' | 00 - | 1 | ● | |
| | 125 | X7 | 08 - | 1 | ● | |
| | 125 | X8 | 04 | 2 | ● | |
| | 125 | X8 | 05 - | 2 | ● | |
| | 125 | X9 | 04 - 05 L | 1 | ● | |

PIAGGIO

| | | | | | | | |
|-----|-----|--------------------------------------|---------|---|---|---|---|
| | 125 | X9 Evo (Hengtong Caliper) | 06 - | L | 1 | ● | |
| | 125 | Xevo | 08 - | | 1 | ● | |
| GTS | 125 | | 07 - | | 1 | ● | |
| GTV | 125 | | 08 - | | 1 | ● | |
| | 150 | Fly | 05 - 09 | | 1 | ● | |
| | 150 | X8 Street | 06 - | | 1 | ● | |
| GTX | 180 | Super Hexagon (Hengtong Caliper) 11' | 00 - | | 1 | ● | |
| GTX | 180 | Super Hexagon (Hengtong Caliper) 12' | 01 - | | 1 | ● | |
| | 200 | Beverly (Hengtong Caliper) | 02 - 06 | | 1 | ● | ● |
| | 200 | Carnaby | 08 - | | 1 | ● | ● |
| GT | 200 | L | 04 - | | 2 | ● | |
| | 200 | X8 | 04 | | 2 | ● | |
| | 200 | X8 | 05 - | | 2 | ● | |
| BV | 200 | | 02 - 04 | | 1 | ● | ● |
| BV | 200 | | 05 - | | 1 | ● | |
| GTS | 250 | ABS | 06 - | | 1 | ● | |
| | 250 | Beverly | 07 - | | 1 | ● | ● |
| | 250 | GT 60 | 06 - | | 1 | ● | |
| | 250 | X7 | 08 - | | 1 | ● | |
| | 250 | X8 | 05 - | | 2 | ● | |
| | 250 | X9 | 05 - | L | 1 | ● | |
| | 250 | Xevo | 08 - | | 1 | ● | |
| BV | 250 | | 06 - | | 1 | ● | ● |
| GTV | 250 | | 08 - | | 1 | ● | |
| | 300 | Beverly Tourer | 07 - | | 1 | ● | ● |
| | 300 | Carnaby Cruiser | 10 - | | 1 | ● | ● |
| X7 | 300 | ie | 10 - | | 1 | ● | |
| GTS | 300 | Super | 09 - | | 1 | ● | |
| | 400 | Beverly ie | 07 - | | | | ● |
| | 400 | X8 | 07 - | L | 1 | ● | ● |
| | 400 | Xevo | 08 - | L | 1 | ● | ● |

SCOOTER

MAXI-SCOOTER

MSC

3061

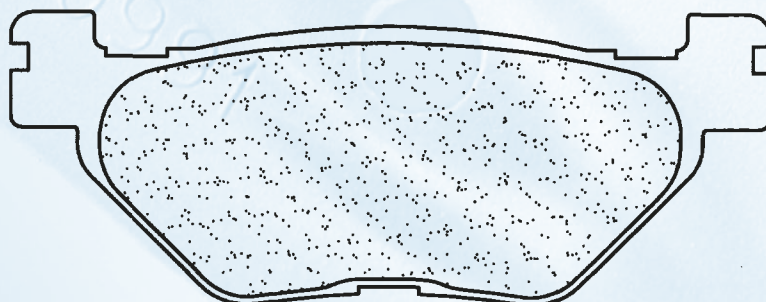

Dim./Size

100 mm

38,5 mm

11,8 mm

SYM

| | | | | | | | |
|---------------|-----|---------------|---------|--|--|---|---|
| GTS | 250 | Voyager | 05 | | | ● | |
| YAMAHA | | | | | | | |
| XP | 500 | T-Max (N/P/R) | 01 - 03 | | | | ● |

SCOOTER MAXI-SCOOTER

SC MSC

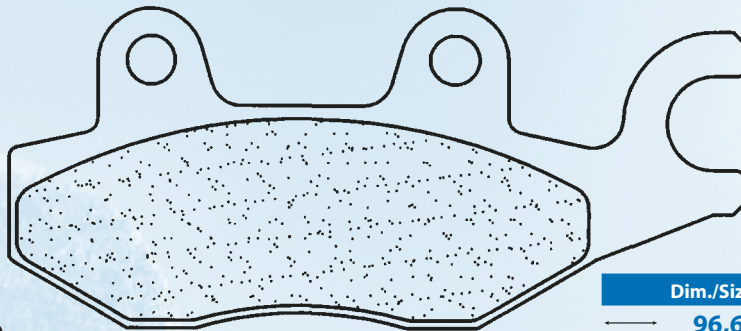
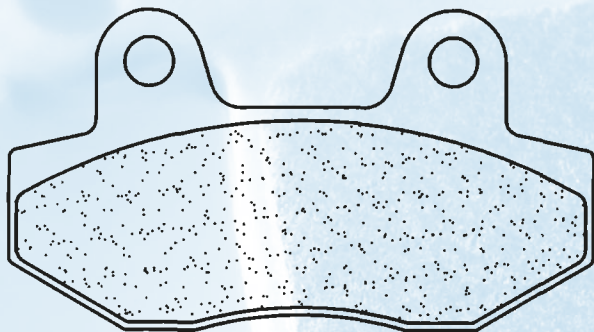

Dim./Size
77 mm
42 mm
9 mm

Dim./Size
96,6 mm
42 mm
9 mm

3062

BENELLI

| | | | | | | |
|-----|-----------|------|---|---|---|--|
| 125 | Caffenero | 08 - | R | 1 | ● | |
| 250 | Caffenero | 08 - | R | 1 | ● | |

JONWAY

| | | | | | | |
|----|-----|---------|--|---|---|---|
| YY | 125 | 08 - 09 | | 1 | ● | ● |
| YY | 150 | 08 - 09 | | 1 | ● | ● |
| YY | 250 | 08 - 09 | | 1 | ● | ● |

KYMCO

| | | | | | | |
|-----|-------------------|------|--|---|---|---|
| 50 | B&W | 04 - | | 1 | ● | |
| 50 | Dink / Dink Sport | 99 - | | 1 | ● | |
| 50 | New Dink | 08 - | | 1 | ● | |
| 50 | Spacer | 99 - | | 1 | ● | |
| 50 | Super 9 A/C | 02 - | | 1 | ● | |
| 50 | Super 9 L/C | 02 - | | 1 | ● | |
| 50 | Yager | 01 - | | 1 | ● | |
| 100 | Cobra Racer | 99 - | | 1 | ● | |
| 125 | B&W | 99 - | | 1 | ● | ● |
| 125 | Dink | 96 - | | 1 | ● | ● |
| 125 | Grand Dink | 02 - | | 1 | ● | ● |
| 125 | Movie | 99 - | | 1 | ● | ● |
| 125 | Movie XL | 01 - | | 1 | ● | ● |
| 125 | New Dink | 08 - | | 1 | ● | ● |
| 125 | Spacer | 99 - | | 1 | ● | ● |
| 125 | Techno GT | 06 - | | 1 | ● | ● |
| 125 | Yager | 01 - | | 1 | ● | ● |
| 125 | Yager GT | 09 - | | 1 | ● | ● |
| 150 | B&W | 01 - | | 1 | ● | ● |

KYMCO

| | | | | | | |
|-----|------------|------|---|---|---|---|
| 150 | Dink | 99 - | | 1 | ● | ● |
| 150 | Grand Dink | 02 - | | 1 | ● | ● |
| 150 | Movie XL | 01 - | | 1 | ● | ● |
| 150 | Spacer | 99 - | | 1 | ● | ● |
| 150 | Yager | 01 - | | 1 | ● | ● |
| 200 | Dink | 04 - | | 1 | ● | ● |
| 200 | i New Dink | 08 - | | 1 | ● | ● |
| 200 | Like i | 09 | | | ● | ● |
| 200 | Like i | 10 | | | ● | ● |
| 200 | Yager | 04 - | | 1 | ● | ● |
| 250 | B&W | 01 - | | 1 | ● | ● |
| 250 | People | 03 - | | 1 | ● | ● |
| S | 250 People | 06 - | R | 1 | ● | ● |
| 250 | Yup | 03 - | | 1 | ● | ● |
| 300 | People Si | 08 - | L | 1 | ● | ● |

SUZUKI

| | | | | | | |
|----|------------------------------|---------|--|---|---|--|
| FD | 112 Shogun R | 04 - | | 1 | ● | |
| FL | 125 SD / Address / Underbone | 07 - 10 | | 1 | ● | |
| FX | 125 | | | 1 | ● | |

SYM

| | | | | | | |
|-----|------------------|---------|--|--|---|--|
| 125 | Euro MX (Euro 2) | 06 - 09 | | | ● | |
| 125 | Shark R | 00 - 02 | | | ● | |
| RS | 125 | 04 - 06 | | | ● | |
| 150 | Shark R | 00 - 02 | | | ● | |
| RS | 150 | 05 - | | | ● | |

SCOOTER MAXI-SCOOTER

SC MSC

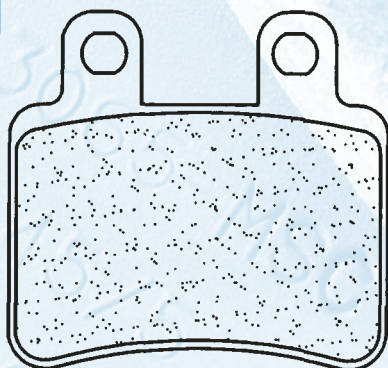

Dim./Size
49,8 mm
47 mm
7 mm

3063

ITALJET

| | | | | | | |
|-----|-----------|------|--|---|---|--|
| 50 | Jet Set | 03 - | | 1 | ● | |
| 100 | Millenium | 02 - | | 1 | ● | |
| 125 | Jet Set | 03 - | | 1 | ● | |
| 125 | Millenium | 02 - | | 1 | ● | |
| 150 | Jet Set | 03 - | | 1 | ● | |
| 150 | Millenium | 02 - | | 1 | ● | |

MBK

| | | | | | | |
|----|---------------------|------|--|--|---|--|
| 50 | X-Limit | 04 - | | | ● | |
| 50 | X-Limit Supermotard | 04 - | | | ● | |

PEUGEOT

| | | | | | | |
|-----|------------------------------|---------|--|--|---|--|
| 50 | Elystar | 02 - 07 | | | ● | |
| 125 | Elyseo | 03 - | | | ● | |
| 125 | Elystar | 03 - | | | ● | |
| 125 | Geopolis | 06 - | | | ● | |
| 125 | Jet Force / Compressor | 03 - | | | ● | |
| 125 | Satelis | 06 - 09 | | | ● | |
| 125 | Satelis Compressor | 06 - 10 | | | ● | |
| 125 | Satelis RS | 07 - 10 | | | ● | |
| 150 | Elyseo | 01 - | | | ● | |
| 150 | Elystar | 03 - | | | ● | |
| 250 | Geopolis (AJP Caliper) / ABS | 06 - 09 | | | ● | |
| 250 | Satelis (AJP Caliper) | 07 - 10 | | | ● | |
| 400 | Geopolis (AJP Caliper) | 07 - 10 | | | ● | |
| 600 | Satelis ABS | 04 - | | | ● | |

SHERCO

| | | | | | | |
|----|----------------------------------------------|---------|--|--|---|--|
| 50 | Enduro (2T) / Urban / SU (Spoke wheel model) | 08 - 10 | | | ● | |
| 50 | SM 0.5 Black Panther | 08 - 10 | | | ● | |
| 50 | SU (2T) Urban Base (Cast wheel model) | 10 - | | | ● | |

YAMAHA

| | | | | | | |
|----|------------------|------|--|--|---|--|
| DT | 50 R | 04 - | | | ● | |
| DT | 50 X Supermotard | 04 - | | | ● | |

SCOOTER

MAXI-SCOOTER

SC

MSC

Dim./Size

53,9 mm

50,7 mm

7,8 mm

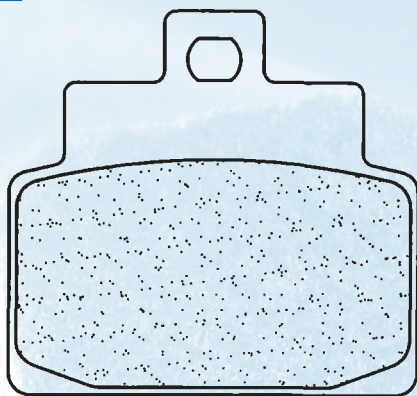

APRILIA

| | | | | |
|-----|----------------------------|---------|---|-----|
| 50 | Scarabeo 4T | 04 - | 1 | ● |
| 100 | Scarabeo | 00 - | 1 | ● |
| 100 | Scarabeo 4T | 03 - | 1 | ● |
| 100 | Scarabeo Net | 10 - | 1 | ● |
| 125 | Habana | 01 - | | ● |
| 125 | Leonardo | 99 - | 1 | ● ● |
| 125 | Leonardo (Grimeca Caliper) | 99 - | | ● |
| 125 | Mojito / Mojito Custom | 02 - | 1 | ● |
| 125 | SR | 99 - | 1 | ● |
| 150 | Leonardo | 99 - | 1 | ● ● |
| 150 | Leonardo (Grimeca Caliper) | 99 - | | ● |
| 150 | SR | 00 - | 1 | ● |
| 250 | Leonardo | 99 - 01 | 1 | ● ● |
| 300 | Leonardo (Grimeca Caliper) | 05 - | | ● |

3064

SCOOTER

MAXI-SCOOTER

MSC

Dim./Size

102 mm

40 mm

8,5 mm

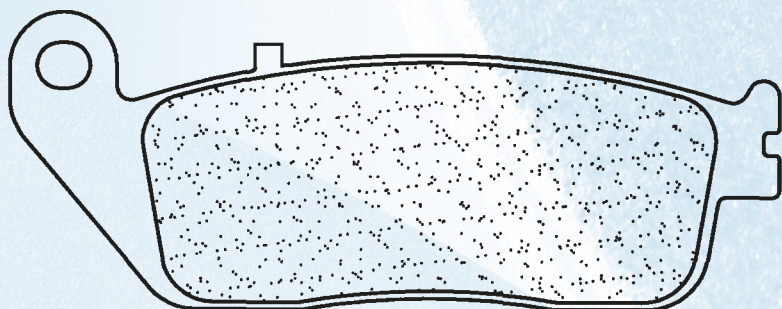

DAELIM

| | | | | | |
|----|-----|-----------|------|---|---|
| S2 | 125 | 05 - | 1 | ● | |
| S2 | 250 | Free Wind | 05 - | 1 | ● |

PEUGEOT

| | | | | |
|-----|-------------|---------|---|---|
| 400 | Geopolis RS | 08 - 10 | 1 | ● |
| 400 | Satelis | 07 - 10 | 2 | ● |
| 500 | Satelis | 07 - 10 | 2 | ● |
| 600 | Satelis ABS | 04 - | 1 | ● |

SUZUKI

| | | | | | |
|----|-----|-------------------|---------|---|---|
| AN | 650 | Burgman / Skywave | 03 - 09 | 2 | ● |
|----|-----|-------------------|---------|---|---|

3065

SCOOTER

MAXI-SCOOTER

MSC

Dim./Size

88 mm

46,1 mm

10 mm

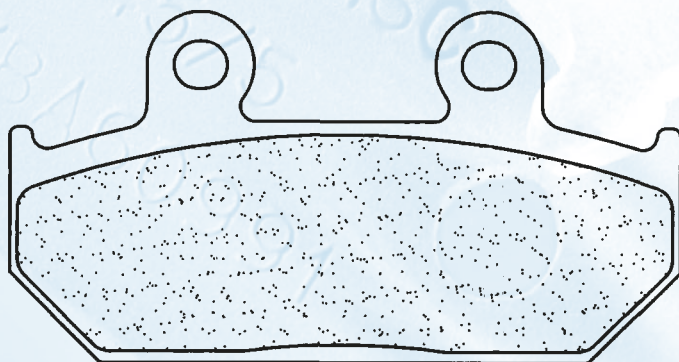

SUZUKI

| | | | | | |
|----|-----|--------------------------------------|---------|--|---|
| AN | 250 | Burgman / Skywave Type M / S / SS | 07 - 08 | | ● |
| AN | 400 | Burgman / Skywave | 07 - | | ● |
| AN | 650 | Burgman / Skywave | 03 - 09 | | ● |

3066

WITH PIN FOR HAND BRAKE
AVEC PION POUR LE FREIN A MAIN

SCOOTER

MAXI-SCOOTER

SC

MSC

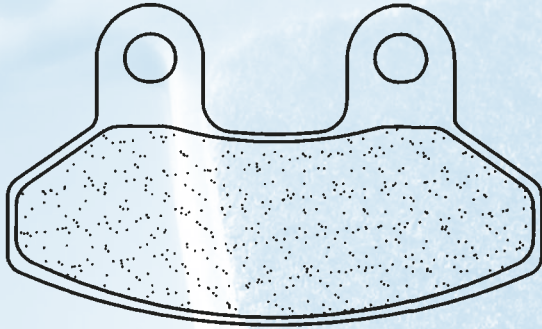

Dim./Size

3067

→ 70 mm
↑ 42 mm
H 8 mm

LAVERDA

| | | | | |
|-----|---------|------|---|---|
| 125 | Phoenix | 01 - | 1 | ● |
| 150 | Phoenix | 01 - | 1 | ● |
| 200 | Phoenix | 01 - | 1 | ● |

SYM

| | | | | |
|------|------------------|---------|---|---|
| 50 | Shark | 99 - 03 | 1 | ● |
| RS | 50 | 04 - 09 | 1 | ● |
| RS21 | 50 | 02 - | 1 | ● |
| RS21 | 125 / R | 02 - | 1 | ● |
| 125 | Euro MX (Euro 1) | 02 - 07 | 1 | ● |
| 125 | Euro MX (Euro 2) | 06 - 09 | 1 | ● |
| 125 | Joyride | 01 - 06 | 1 | ● |
| 125 | Joyride Evo i | 09 - 10 | 1 | ● |
| 125 | Joyride i | 07 - 09 | 1 | ● |
| 125 | Shark | 99 - 02 | 1 | ● |
| 125 | Shark R | 00 - 02 | 1 | ● |
| 125 | SK | 03 - 04 | 1 | ● |
| RS | 125 | 04 - 06 | 1 | ● |
| VS | 125 | 06 - 09 | 1 | ● |
| 150 | Euro MX | 03 - | 1 | ● |
| 150 | Joyride | 01 - 06 | 1 | ● |
| 150 | Shark | 99 - 02 | 1 | ● |
| 150 | Shark R | 00 - 02 | 1 | ● |
| VS | 150 | 06 - 08 | 1 | ● |
| RS | 150 | 05 - | 1 | ● |
| 200 | Joyride | 03 - 07 | 1 | ● |
| 200 | Joyride Evo i | 09 - 10 | 1 | ● |
| 200 | Joyride i | 07 - 09 | 1 | ● |

SCOOTER

MAXI-SCOOTER

SC

MSC

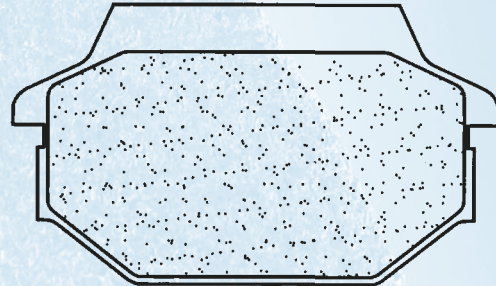
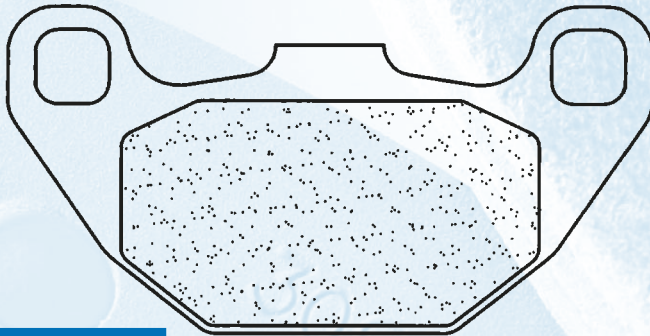

Dim./Size

3068

→ 64 mm
↑ 36,8 mm
H 11 mm

Dim./Size

→ 85 mm
↑ 43 mm
H 8,5 mm

KYMCO

| | | | |
|-----|-------------------|------|---|
| 50 | Agility (4T) RT16 | 06 - | ● |
| 50 | People | 99 - | ● |
| 50 | Super 8 | 08 - | ● |
| 50 | Super 9 L/C | | ● |
| 125 | People | 01 - | ● |
| S | 125 People | 05 - | ● |
| 125 | Super 8 | 08 - | ● |
| 125 | Super 9 | | ● |
| 150 | People | 01 - | ● |
| 200 | Like i | 09 | ● |
| S | 200 People | 05 - | ● |
| 250 | Super 9 | | ● |

LAVERDA

| | | | |
|-----|---------|--|---|
| 125 | Phoenix | | ● |
| 150 | Phoenix | | ● |
| 200 | Phoenix | | ● |

SYM

| | | | |
|-----|---------|---------|---|
| 125 | Joyride | | ● |
| 125 | SK | | ● |
| HD | 125 | 04 - 07 | ● |
| 150 | Joyride | | ● |
| 200 | HD | 04 - 07 | ● |
| 200 | Joyride | | ● |
| GT | 500 | | ● |

SCOOTER MAXI-SCOOTER

SC MSC

3069

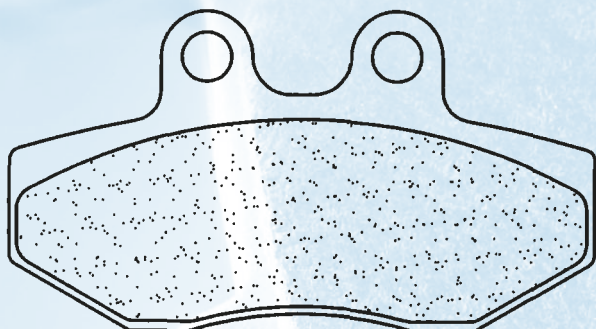

Dim./Size

→ **77 mm**
↑↓ **42 mm**
H **7,5 mm**

| APRILIA | | | | | |
|---------|----|-------------|---------|---|---|
| 50 | RX | | 06 - | 1 | ● |
| BETA | | | | | |
| RR | 50 | Enduro | 99 - | 1 | ● |
| RR | 50 | Enduro | 10 - | 1 | ● |
| RR | 50 | Enduro Alu | 04 - 07 | 1 | ● |
| RR | 50 | Motard Alu | 04 - | 1 | ● |
| RR | 50 | Pro Race | 98 - | 1 | ● |
| RR | 50 | Standard | 99 - | 1 | ● |
| RR | 50 | Supermotard | 99 - 03 | 1 | ● |

BUTALCO

| | | | | |
|----|--------|------|---|---|
| 50 | Astro | 01 - | 1 | ● |
| 50 | Lobito | 99 - | 1 | ● |

DERBI

| | | | | | |
|-----|----|-------------|---------|---|---|
| GPR | 50 | R | 98 - 04 | 1 | ● |
| SM | 50 | Senda R DRD | 03 - 04 | 1 | ● |

GAS GAS

| | | | | | |
|----|----|--------|---------|---|---|
| EC | 50 | Rookie | 01 - 04 | 1 | ● |
| SM | 50 | Rookie | 01 - | 1 | ● |

GILERA

| | | | | | |
|-----|-----|--------|---------|---|---|
| FX | 125 | Runner | 97 - 99 | 1 | ● |
| FX | 150 | Runner | 97 - | 1 | ● |
| FXR | 180 | Runner | 97 | 1 | ● |
| FX | 200 | Runner | 97 - 98 | 1 | ● |

HRD

| | | | | |
|----|---------------------|---------|---|---|
| 50 | Sonic 2 Supermotard | 00 - 02 | 1 | ● |
| 50 | Sonic 2 Trail | 00 - 02 | 1 | ● |

HUSQVARNA

| | | | | |
|----|----|------|---|---|
| 50 | SM | 02 - | 1 | ● |
| 50 | WR | 02 - | 1 | ● |

ITALJET

| | | | | | |
|----|----|--|------|---|---|
| SM | 50 | | 02 - | 1 | ● |
|----|----|--|------|---|---|

MBK

| | | | | |
|-----|---------|---------|---|---|
| 125 | Flame X | 04 - 10 | 1 | ● |
|-----|---------|---------|---|---|

MH (MOTORHISPANIA)

| | | | | | |
|-----|----|-------------|------|---|---|
| RX | 50 | Racing | 00 - | 1 | ● |
| RYZ | 50 | Supermotard | 05 - | 1 | ● |

PEUGEOT

| | | | | | |
|------|----|--|---------|---|---|
| XR-6 | 50 | | 02 - 07 | 1 | ● |
|------|----|--|---------|---|---|

RIEJU

| | | | | | |
|-----|-----------|---------|---------|---|---|
| MRX | 50 | Castrol | 01 - 02 | 1 | ● |
| RR | 50 | Castrol | 00 - 02 | 1 | ● |
| 50 | Spike pro | 04 | 1 | ● | |
| RS1 | 50 | | 01 - | 1 | ● |

SHERCO

| | | | | |
|----|----------------------------------------------|---------|---|---|
| 50 | Enduro (2T) | 02 - 07 | 1 | ● |
| 50 | Enduro (2T) / Urban / SU (Spoke wheel model) | 08 - 10 | 1 | ● |
| 50 | Supermotard (2T) | 02 - 07 | 1 | ● |

SIAMOTO

| | | | | |
|-----|---------|------|---|---|
| 125 | BD / KD | 02 - | 1 | ● |
|-----|---------|------|---|---|

SCOOTER MAXI-SCOOTER

MSC

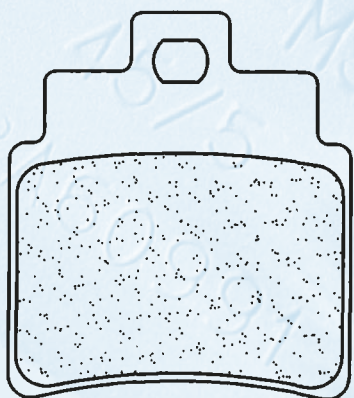

Dim./Size

→ **45 mm**
↑↓ **50,8 mm**
H **7 mm**

KYMCO

| | | | | |
|-----|------------|------|---|---|
| 250 | Grand Dink | 01 - | 1 | ● |
|-----|------------|------|---|---|

SYM

| | | | | | |
|-----|-----|--------------|---------|---|---|
| GTS | 250 | JoyMax | 06 | 2 | ● |
| GTS | 250 | JoyMax i | 07 - 09 | 1 | ● |
| GTS | 250 | Voyager | 05 | 2 | ● |
| GTS | 300 | | 08 - 09 | 2 | ● |
| GTS | 300 | Joymax Evo i | 09 - | 2 | ● |

3070

SCOOTER MAXI-SCOOTER

MSC

KYMCO

250 Grand Dink



01 -

1

Dim./Size

→ 55,4 mm

↑ 46 mm

H 7 mm

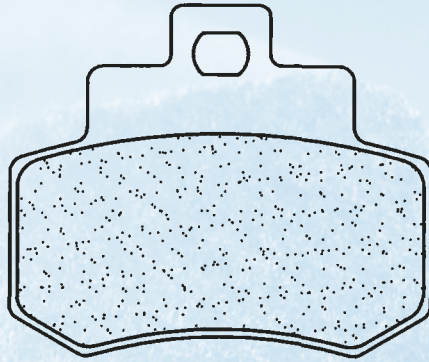

3071

SCOOTER MAXI-SCOOTER

MSC

APRILIA

500 Atlantic
500 Scarabéo



02 - 05 R 1

1

03 - 09 R 1

1

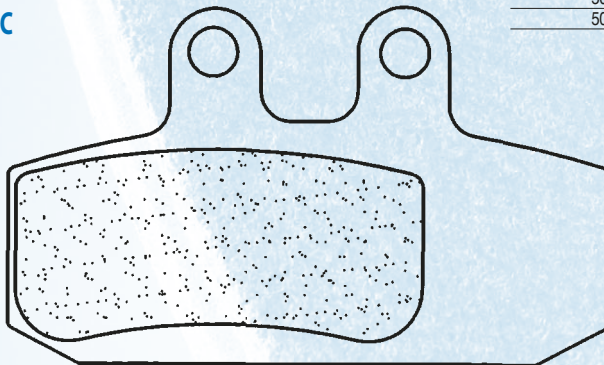

Dim./Size

→ 79 mm

↑ 47,1 mm

H 7,4 mm

3072

SCOOTER MAXI-SCOOTER

MSC

HONDA

| | | | | | |
|-----|-----|-------|------|---|---|
| SCV | 110 | Lead | 08 - | 1 | ● |
| CH | 125 | Spacy | 94 - | 1 | ● |
| SES | 125 | Dylan | 02 - | 1 | ● |
| PS | 125 | i | 07 - | 1 | ● |
| PS | 150 | i | 07 - | 1 | ● |
| SES | 150 | Dylan | 02 - | 1 | ● |

ITALJET

| | | | | | |
|--|-----|---------|------|---|---|
| | 125 | Torpedo | 07 - | 1 | ● |
| | 150 | Torpedo | 07 - | 1 | ● |

MZ / MUZ

| | | | | | |
|--|-----|-----------|---------|---|---|
| | 125 | Mantizz S | 05 - 07 | 1 | ● |
|--|-----|-----------|---------|---|---|

SUZUKI

| | | | | | |
|----|-----|-------------------|---------|--|---|
| AN | 250 | Burgman / Skywave | 98 - 03 | | ● |
| AN | 400 | Burgman / Skywave | 99 - 00 | | ● |

Dim./Size

→ 81,1 mm

↑ 42 mm

H 9,3 mm

3073

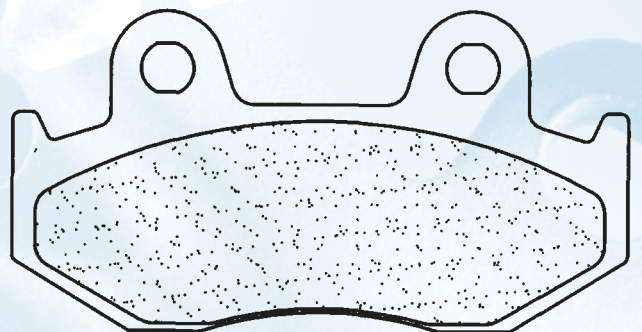

SCOOTER MAXI-SCOOTER

MSC

3074

WITH PIN FOR HAND BRAKE
AVEC PION POUR LE FREIN A MAIN

| Dim./Size | |
|-----------|---------|
| → | 81,1 mm |
| ↑ | 42 mm |
| H | 8,5 mm |

| KAWASAKI | | | | |
|----------|-----|-------------------|---------|---|
| SC | 250 | Epsilon | 02 - | ● |
| SUZUKI | | | | |
| AN | 250 | Burgman / Skywave | 04 - 06 | ● |
| AN | 400 | Burgman / Skywave | 01 - 06 | ● |

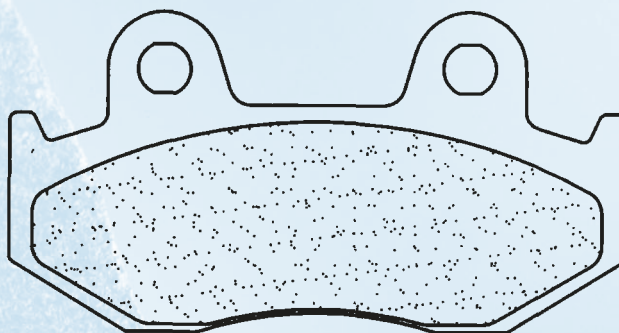

SCOOTER MAXI-SCOOTER

MSC

| MBK | | | | |
|--------|-----------|-----------------|---------|---|
| 400 | Ski liner | 04 - | ● | |
| YAMAHA | | | | |
| CP | 250 | Maxam / Morphus | 05 - 08 | ● |
| YP | 400 | Majesty | 04 | ● |
| YP | 400 | Majesty | 05 - | ● |
| XP | 500 | T-Max (S/T/V) | 04 - 07 | ● |
| XP | 500 | T-Max (4B5) | 08 - | ● |

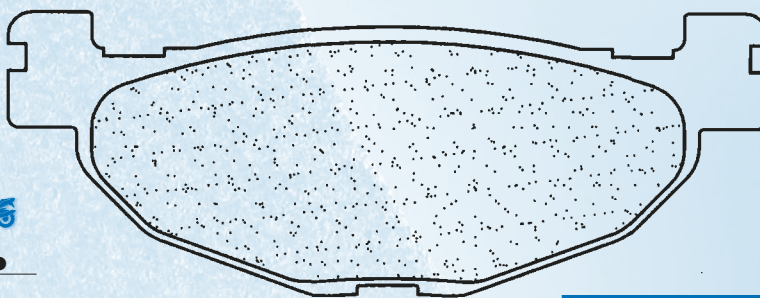

| Dim./Size | |
|-----------|---------|
| → | 100 mm |
| ↑ | 37,3 mm |
| H | 12 mm |

WITH PIN FOR HAND BRAKE
AVEC PION POUR LE FREIN A MAIN

3075

SCOOTER MAXI-SCOOTER

MSC

| HONDA | | | | |
|-------|-----|-----------|------|---|
| FES | 125 | Panthéon | 03 - | ● |
| FES | 150 | Panthéon | 03 - | ● |
| FES | 250 | Foresight | 00 - | ● |

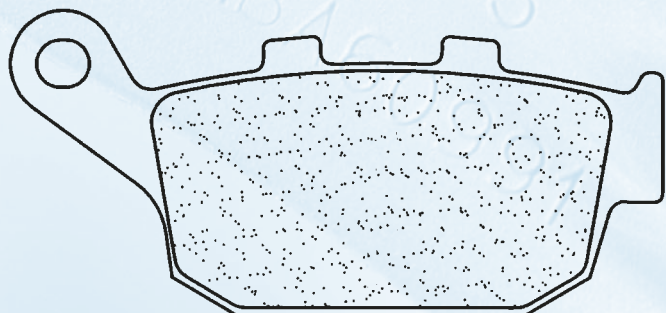

| Dim./Size | |
|-----------|---------|
| → | 86 mm |
| ↑ | 40,1 mm |
| H | 10 mm |

3076

SCOOTER MAXI-SCOOTER

MSC

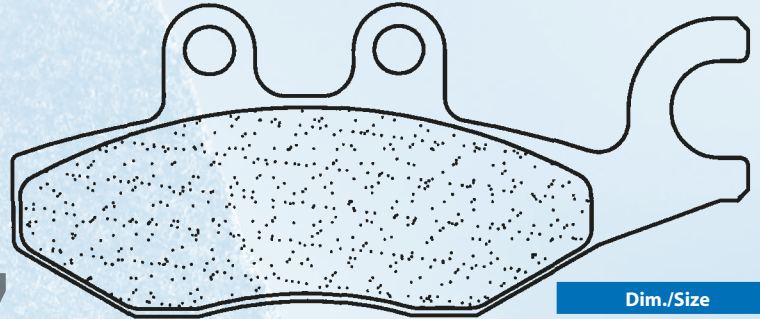
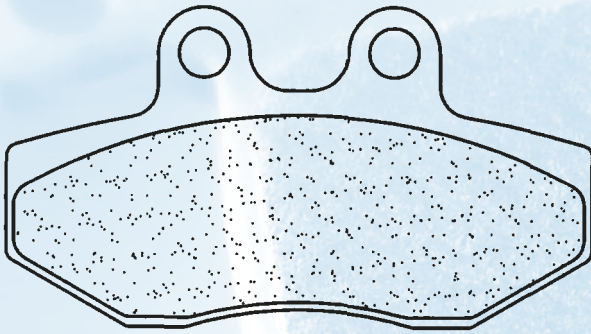

Dim./Size

76,9 mm

41 mm

9 mm

3077

Dim./Size

96,7 mm

41 mm

9 mm

SCOOTER MAXI-SCOOTER

SC

MSC

3078

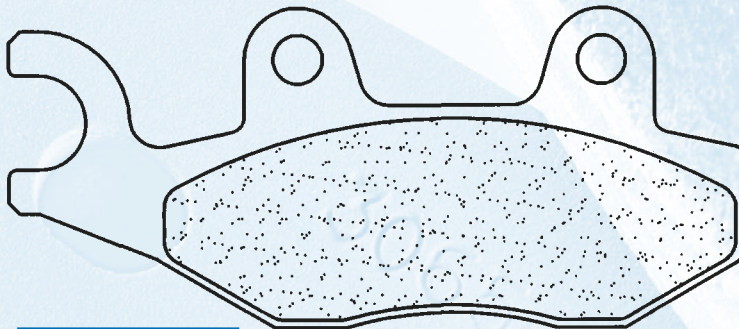

Dim./Size

96,6 mm

42 mm

9,2 mm

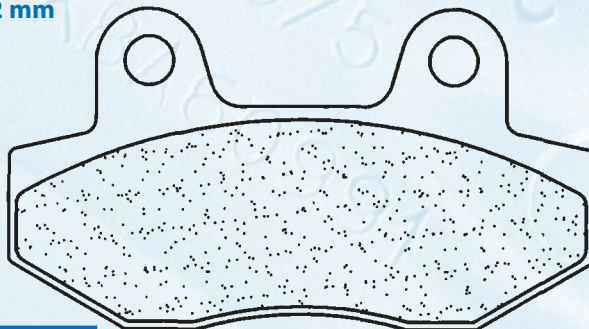

Dim./Size

77 mm

42 mm

9,2 mm

PIAGGIO

| | | | | | |
|-----|---------------------------|---------|---|---|---|
| 125 | X7 | 08 - | | | ● |
| 125 | X9 | 04 - 05 | R | 1 | ● |
| 125 | X9 Evo (Henglong Caliper) | 06 - | R | 1 | ● |
| 125 | Xevo | 08 - | | | ● |
| 250 | X7 | 08 - | | | ● |
| 250 | X9 | 05 - | R | 1 | ● |
| 250 | Xevo | 08 - | | | ● |
| X7 | 300 ie | 10 - | | | ● |
| 300 | MP3 LT | 10 - | | | ● |
| 400 | X8 | 07 - | R | 1 | ● |
| 400 | Xevo | 08 - | R | 1 | ● |
| 500 | MP3 ie | 09 - 10 | | | ● |

DAELIM

| | | | | | |
|-----|---------|------|--|---|---|
| 50 | A-Four | 06 - | | 1 | ● |
| 125 | Delfino | 08 - | | 1 | ● |

KEEWAY

| | | | | | |
|-----|---------|---------|--|---|---|
| 100 | Partner | 06 - | | 1 | ● |
| 110 | Partner | 06 - | | 1 | ● |
| 125 | Outlook | 07 - 10 | | 1 | ● |

KYMCO

| | | | | | |
|-----|--------------------------|------|---|---|---|
| 50 | Agility | 05 - | | 1 | ● |
| 50 | Agility (4T) RT10 / RT12 | 06 - | | 1 | ● |
| RS | 50 Agility Naked | 10 - | | 1 | ● |
| 50 | Filly LX | 02 - | | 1 | ● |
| 50 | Jetix | 10 - | | | ● |
| 50 | Vitality | 04 - | | 1 | ● |
| 50 | Yup | 02 - | | 1 | ● |
| 125 | Agility | 06 - | | 1 | ● |
| 125 | Vivio | 01 - | | 1 | ● |
| 150 | Vivio | 01 - | | 1 | ● |
| 200 | Like i | 10 - | | 1 | ● |
| S | 250 People | 06 - | L | 1 | ● |
| 300 | People Si | 08 - | R | 1 | ● |

MALAGUTI

| | | | | | |
|-----|-----------|------|--|---|---|
| 125 | Blog | 10 - | | 1 | ● |
| 125 | Centro ie | 08 - | | 1 | ● |
| 160 | Blog | 10 - | | 1 | ● |
| 160 | Centro ie | 08 - | | 1 | ● |

PEUGEOT

| | | | | | |
|-----|---------------------------------|---------|--|---|---|
| 125 | Geopolis RS | 08 - 10 | | 1 | ● |
| 125 | Satelis (Nissin Caliper) | 08 - 09 | | 1 | ● |
| 125 | Vivacity (4T) | 10 - | | 1 | ● |
| 250 | Geopolis (Nissin Caliper) / ABS | 06 - 09 | | 1 | ● |
| 250 | Satelis (Nissin Caliper) | 06 - 10 | | 1 | ● |
| 300 | Geopolis | 10 - | | 1 | ● |
| 300 | Geostyle | 10 - | | 1 | ● |
| 400 | Geopolis (Nissin Caliper) / ABS | 07 - 10 | | 1 | ● |
| 400 | Geopolis RS | 08 - 10 | | | ● |
| 400 | Satelis | 07 - 10 | | | ● |
| 500 | Satelis | 07 - 10 | | | ● |

PGO

| | | | | | |
|-----|-------------------------|------|--|---|---|
| 125 | I-Charge Fuel injection | 03 - | | 1 | ● |
|-----|-------------------------|------|--|---|---|

TGB

| | | | | | |
|-----|-----------|------|--|---|---|
| 50 | 203 | 05 - | | 1 | ● |
| 50 | Apollo | 99 - | | 1 | ● |
| 50 | Fire, Sky | 03 - | | 1 | ● |
| 90 | Apollo | 99 - | | 1 | ● |
| 250 | Dynasty | 06 - | | 1 | ● |

SCOOTER

MAXI-SCOOTER

MSC

HONDA

| | | | | |
|-----|-----|-------|---------|---|
| NSS | 250 | Forza | 00 - 04 | ● |
| NSS | 250 | Jazz | 01 - 04 | ● |

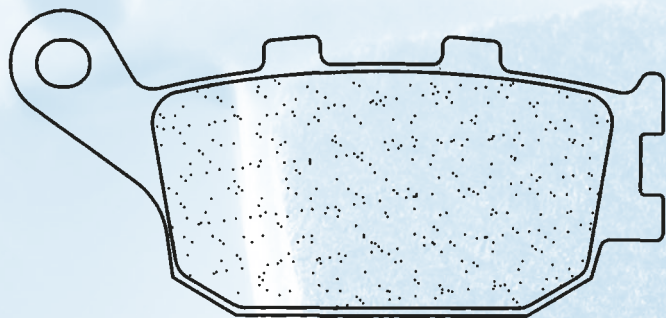

3079

Dim./Size

86 mm

40,1 mm

8,9 mm

SCOOTER

MAXI-SCOOTER

MSC

HONDA

| | | | | | |
|-----|-----|--------|------|---|---|
| ANF | 125 | Innova | 03 - | 1 | ● |
|-----|-----|--------|------|---|---|

RIEJU

| | | | | | |
|-----|----|----|---------|---|---|
| RS2 | 50 | FR | 09 - 10 | 1 | ● |
|-----|----|----|---------|---|---|

| | | | | | |
|-----|----|-------------------------|---------|---|---|
| RS2 | 50 | Matrix (J.Juan Caliper) | 07 - 09 | 1 | ● |
|-----|----|-------------------------|---------|---|---|

| | | | | | |
|--|----|-----|---------|---|---|
| | 50 | NKD | 08 - 10 | 1 | ● |
|--|----|-----|---------|---|---|

| | | | | | |
|-----|----|----------------------|---------|---|---|
| RS2 | 50 | Pro (J.Juan Caliper) | 07 - 10 | 1 | ● |
|-----|----|----------------------|---------|---|---|

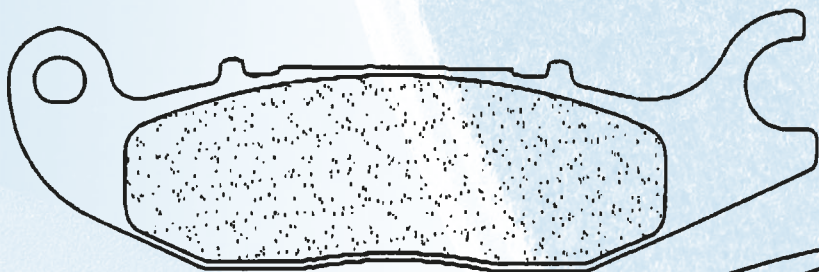

3080

Dim./Size

111 mm

36,2 mm

7,6 mm

Dim./Size

98,6 mm

33 mm

7,6 mm

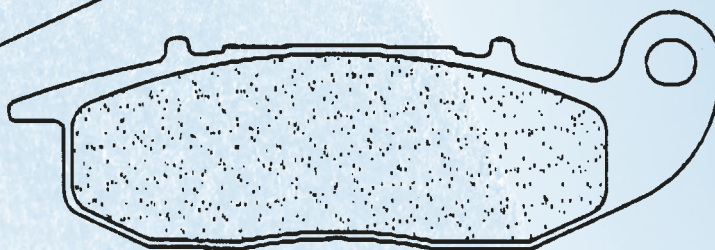

SCOOTER

MAXI-SCOOTER

SC

MSC

3081

ITALJET

| | | | | | |
|--|-----|---------|------|--|---|
| | 250 | Jupiter | 02 - | | ● |
|--|-----|---------|------|--|---|

RIEJU

| | | | | | |
|-----|----|----------------------|---------|---|---|
| RS2 | 50 | Matrix (AJP Caliper) | 02 - 08 | 1 | ● |
|-----|----|----------------------|---------|---|---|

| | | | | | |
|--|----|-----|----|---|---|
| | 50 | NKD | 07 | 1 | ● |
|--|----|-----|----|---|---|

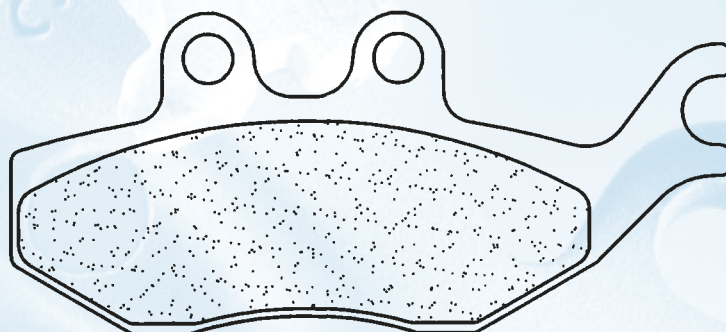
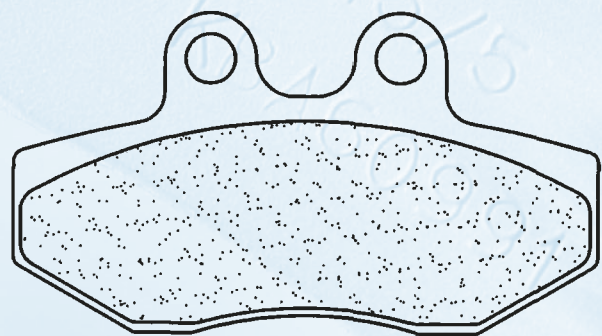

Dim./Size

77 mm

42 mm

7,5 mm

Dim./Size

94,5 mm

42 mm

7,5 mm

SCOOTER MAXI-SCOOTER

MSC

HONDA

| | | | | | |
|-----|-----|--------|------|---|---|
| SH | 125 | i | 09 - | 1 | ● |
| FES | 125 | S-wing | 07 - | 1 | ● |
| SH | 150 | i | 09 - | 1 | ● |
| FES | 150 | S-wing | 08 - | 1 | ● |
| NSS | 250 | Forza | 05 - | 1 | ● |

HONDA

| | | | | | |
|-----|-----|---------------|------|---|---|
| NSS | 250 | Jazz | 05 - | 1 | ● |
| PS | 250 | | 05 - | 1 | ● |
| SH | 300 | i / i (ABS) | 07 - | 1 | ● |
| SWT | 400 | / ABS | 09 - | 1 | ● |
| FJS | 400 | Silver Wing T | 09 - | 1 | ● |

SUZUKI

| | | | | | |
|----|-----|---------|------|---|---|
| UH | 125 | Burgman | 07 - | 1 | ● |
| UX | 125 | SIXteen | 08 - | 1 | ● |
| UX | 150 | SIXteen | 08 - | 1 | ● |
| UH | 200 | Burgman | 07 - | 1 | ● |

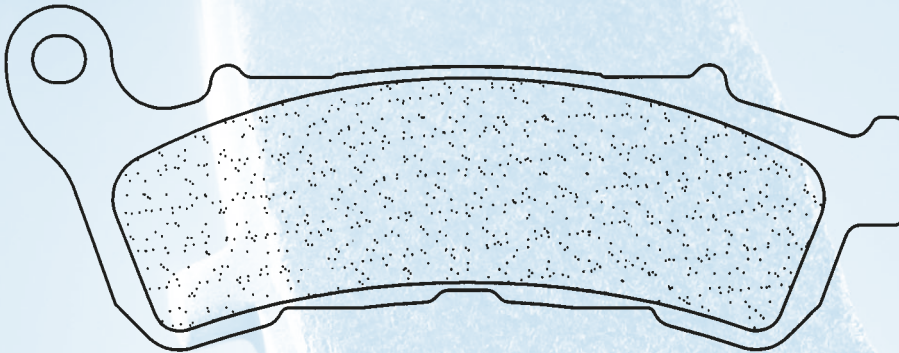

3082

Dim./Size

→ 117,9 mm
↑ ↓ 45,4 mm
H 9 mm

SCOOTER MAXI-SCOOTER

MSC

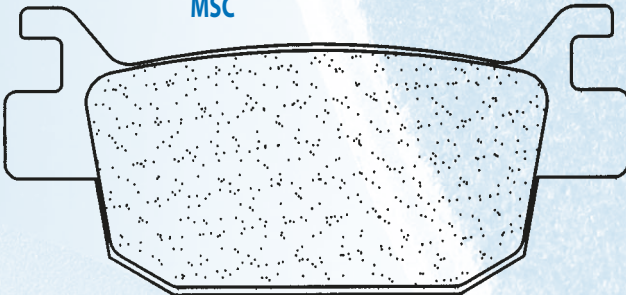

HONDA

| | | | | |
|-----|-----|-------------|------|---|
| SH | 125 | i | 09 - | ● |
| FES | 125 | S-wing | 07 - | ● |
| SH | 150 | i | 09 - | ● |
| FES | 150 | S-wing | 08 - | ● |
| NSS | 250 | Forza | 05 - | ● |
| NSS | 250 | Jazz | 05 - | ● |
| SH | 300 | i / i (ABS) | 07 - | ● |

Dim./Size

→ 81,7 mm
↑ ↓ 37,9 mm
H 9,5 mm

3083

SCOOTER MAXI-SCOOTER

MSC

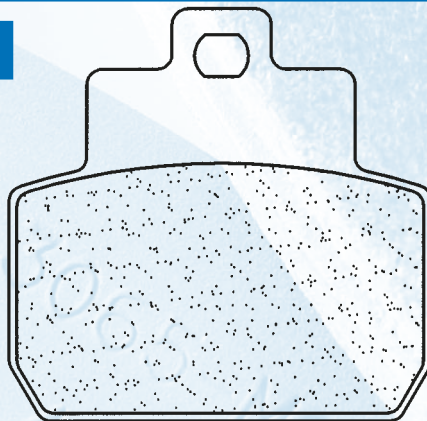

Dim./Size

→ 55,4 mm
↑ ↓ 54,5 mm
H 8 mm

3084

GILERA

| | | | | |
|----|-----|----------|------|---|
| RC | 500 | Fuoco ie | 08 - | ● |
|----|-----|----------|------|---|

PIAGGIO

| | | | | |
|-----|-----|---------------------------|---------|---|
| GTV | 125 | | 08 - | ● |
| | 125 | MP3 | 06 - 08 | ● |
| | 125 | MP3 ie | 08 - 10 | ● |
| | 125 | MP3 Hybrid | 09 - 10 | ● |
| | 125 | X8 | 05 - | ● |
| | 125 | X9 Evo (Hengtong Caliper) | 06 - | ● |
| | 200 | X8 | 05 - | ● |
| | 250 | MP3 ie / LT | 06 - 09 | ● |
| | 250 | X8 | 05 - | ● |
| | 250 | X9 | 05 - | ● |
| GTV | 250 | | 08 - | ● |
| | 400 | MP3 ie | 07 - | ● |
| | 400 | MP3 LT | 09 - | ● |
| | 500 | Beverly | 06 | ● |

SCOOTER MAXI-SCOOTER

MSC

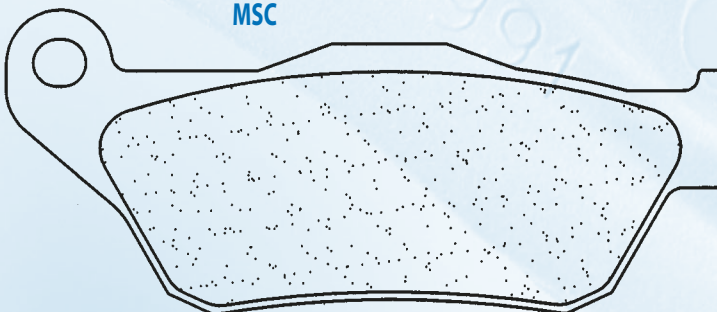

MBK

| | | | | | |
|--|-----|------------|---------|---|---|
| | 125 | Skycruiser | 06 - 09 | 1 | ● |
|--|-----|------------|---------|---|---|

YAMAHA

| | | | | | |
|----|-----|-------------|---------|---|---|
| YP | 125 | BLACK X-Max | 09 - | 1 | ● |
| YP | 125 | R X-Max | 06 - 09 | 1 | ● |
| YP | 250 | R X-Max | 05 - 09 | 1 | ● |

Dim./Size

→ 94 mm
↑ ↓ 39,9 mm
H 7,3 mm

3085

SCOOTER MAXI-SCOOTER

MSC

SUZUKI

| | | | | | | | |
|----|-----|-----------------------------------|---------|---|---|---|---|
| AN | 250 | Burgman / Skywave Type M / S / SS | 07 - 08 | R | 1 | ● | ● |
| AN | 400 | Burgman / Skywave | 07 - | R | 1 | ● | ● |

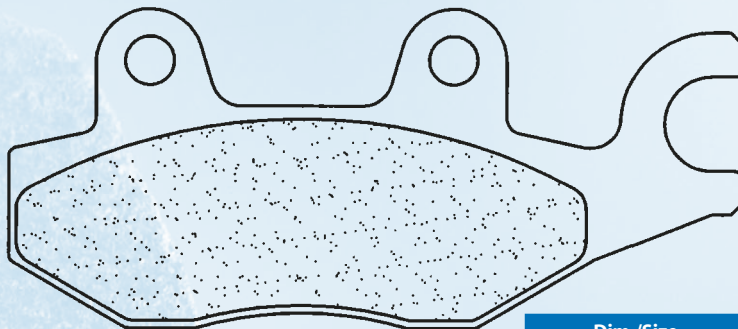
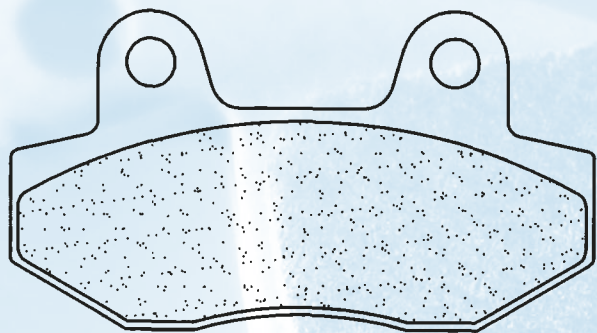

Dim./Size

→ 77 mm
↑↓ 42 mm
H 8 mm

Dim./Size

→ 96,6 mm
↑↓ 42 mm
H 8 mm

3086

SCOOTER MAXI-SCOOTER

MSC

BENELLI

| | | | | | | |
|-----|-----------|------|---|---|---|---|
| 125 | Caffenero | 08 - | L | 1 | ● | ● |
| 125 | Macis | 10 - | | 1 | ● | ● |
| 150 | Macis | 10 - | | 1 | ● | ● |
| 250 | Caffenero | 08 - | L | 1 | ● | ● |

PGO

| | | | | | | |
|-----|-------|------|--|---|---|---|
| 125 | Libra | 10 - | | 1 | ● | ● |
| 125 | X Hot | 10 - | | 1 | ● | ● |

QUINGOI

| | | | | | | | |
|----|-----|----|------|--|---|---|---|
| QM | 125 | GY | 02 - | | 1 | ● | ● |
|----|-----|----|------|--|---|---|---|

SUZUKI

| | | | | | | | |
|----|-----|-----------------------------------|---------|---|---|---|---|
| AN | 250 | Burgman / Skywave Type M / S / SS | 07 - 08 | L | 1 | ● | ● |
| AN | 400 | Burgman / Skywave | 07 - | L | 1 | ● | ● |

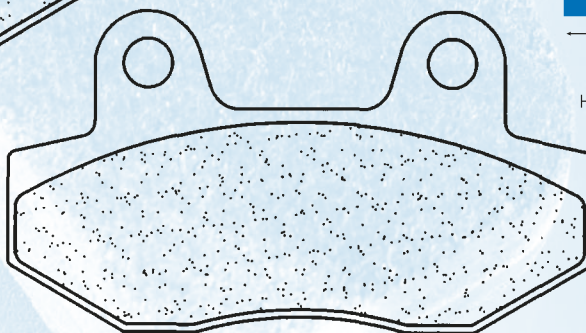
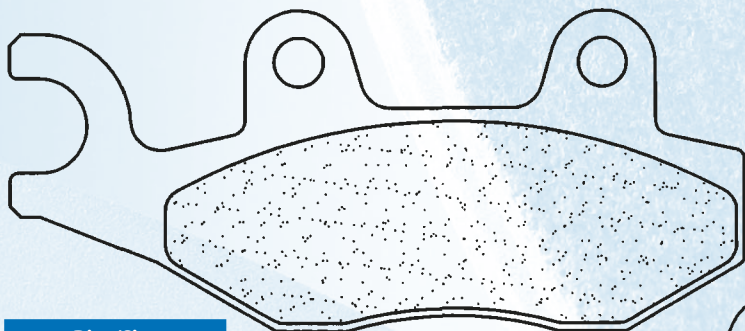

Dim./Size

→ 96,6 mm
↑↓ 42 mm
H 8 mm

Dim./Size

→ 77 mm
↑↓ 42 mm
H 8 mm

3087

SCOOTER MAXI-SCOOTER

MSC

KYMCO

| | | | | | | | |
|---|-----|------------|------|--|--|---|---|
| S | 125 | People | 05 - | | | ● | ● |
| S | 200 | People | 05 - | | | ● | ● |
| S | 250 | People | 06 - | | | ● | ● |
| | 250 | Xciting | 06 - | | | ● | ● |
| | 300 | People Gti | 10 - | | | ● | ● |
| | 300 | People Si | 08 - | | | ● | ● |
| | 300 | Xciting Ri | 08 - | | | ● | ● |

PEUGEOT

| | | | | | | | |
|--|-----|-----|------|--|--|---|---|
| | 125 | LXR | 10 - | | | ● | ● |
| | 200 | LXR | 10 - | | | ● | ● |

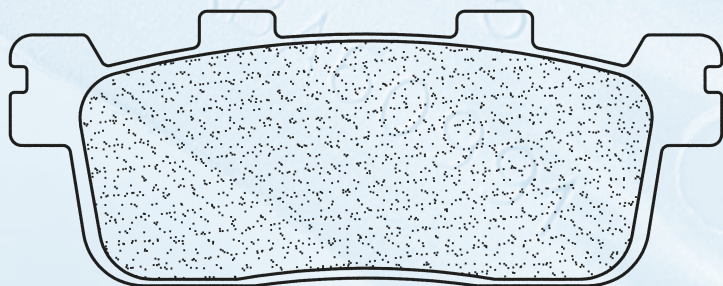

Dim./Size

→ 93,9 mm
↑↓ 36,2 mm
H 10,5 mm

3089

SCOOTER MAXI-SCOOTER

MSC

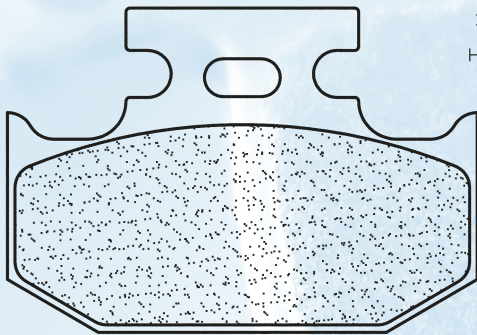

Dim./Size

→ 62 mm
↑↓ 40,8 mm
H 10,2 mm

Dim./Size

→ 82 mm
↑↓ 40,8 mm
H 10,2 mm

SUZUKI

| | | | | |
|----|-----|---------|------|---|
| UH | 125 | Burgman | 07 - | ● |
| UX | 125 | SIXteen | 08 - | ● |
| UX | 150 | SIXteen | 08 - | ● |
| UH | 200 | Burgman | 07 - | ● |

3090

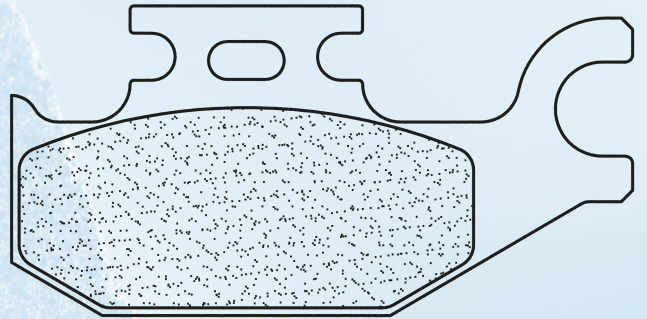

SCOOTER MAXI-SCOOTER

MSC

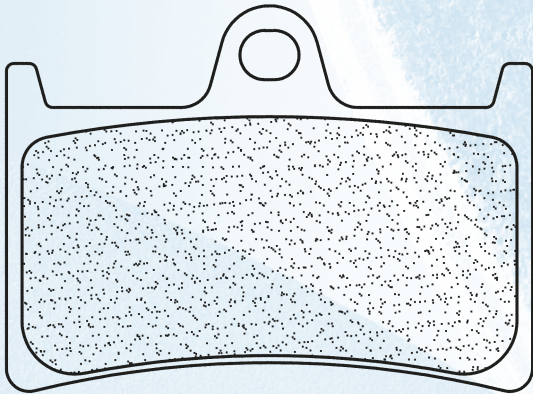

Dim./Size

→ 69,4 mm
↑↓ 50,8 mm
H 7 mm

YAMAHA

| | | | | | |
|----|-----|-------------|------|---|---|
| XP | 500 | T-Max (4B5) | 08 - | 2 | ● |
|----|-----|-------------|------|---|---|

3091

SCOOTER MAXI-SCOOTER

MSC

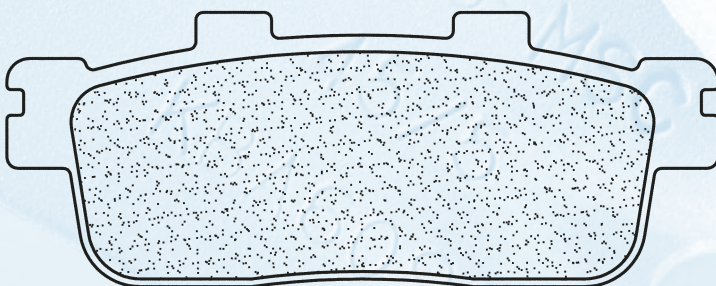

Dim./Size

→ 93,9 mm
↑↓ 36,2 mm
H 10,2 mm

SYM

| | | | | | |
|-----|-----|------------------|---------|---|---|
| GTS | 125 | Joymax / Voyager | 06 - 09 | 1 | ● |
| | 125 | Citycom | 08 - | | ● |
| HD | 125 | Evo i | 07 - 10 | | ● |
| | 125 | Joyride i | 07 - 09 | | ● |
| | 125 | Joyride Evo i | 09 - 10 | | ● |
| | 200 | HD Evo | 07 | | ● |
| | 200 | HD Evo i | 07 - 09 | | ● |
| | 200 | Joyride i | 07 - 09 | | ● |
| | 200 | Joyride Evo i | 09 - 10 | | ● |
| GTS | 250 | JoyMax | 06 | | ● |
| GTS | 250 | JoyMax i | 07 - 09 | | ● |
| GTS | 300 | | 08 - 09 | | ● |
| GTS | 300 | Citycom i | 08 - 09 | | ● |
| GTS | 300 | Joymax Evo i | 09 - | | ● |
| TGB | | | | | |
| | 125 | X-Motion | 08 - | | ● |
| | 250 | X-Motion i | 08 - | | ● |

3092

SCOOTER MAXI-SCOOTER

MSC

3094

KYMCO

| | | | |
|-----|----------------|------|---|
| 125 | Downtown i | 10 - | ● |
| 200 | Downtown i | 10 - | ● |
| 300 | Downtown i ABS | 10 - | ● |



Dim./Size

90 mm

33,4 mm

9,8 mm

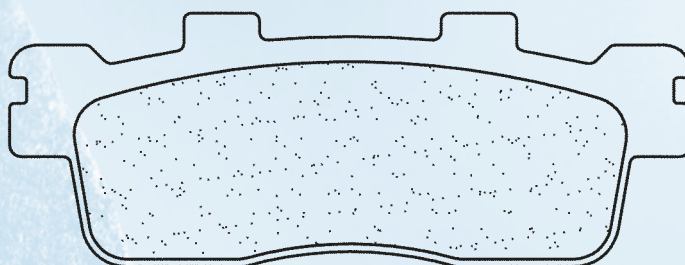
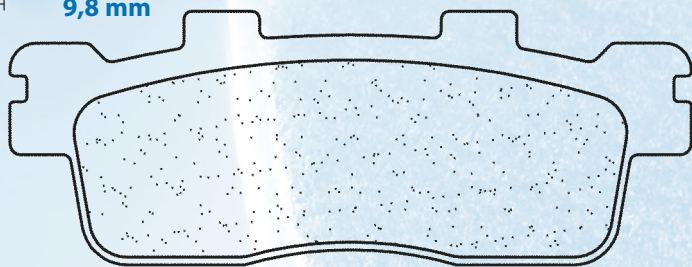

SCOOTER MAXI-SCOOTER

MSC

3095

MBK

| | | | |
|-----|----------------|------|---|
| 125 | Skycruiser ABS | 11 - | ● |
|-----|----------------|------|---|

YAMAHA

| | | | |
|----|-----------------|------|---|
| YP | 125 R X-Max ABS | 11 - | ● |
|----|-----------------|------|---|



Dim./Size

99,8 mm

31 mm

9 mm

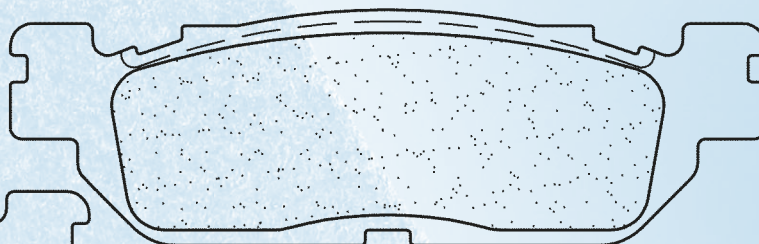

SCOOTER MAXI-SCOOTER

SC

MSC

3096

KYMCO

| | | | | |
|-----|-----------|---------|---|---|
| 50 | Active SR | 08 - | 1 | ● |
| 50 | Jetix | 10 - | 1 | ● |
| 50 | Nexxon | 08 - | 1 | ● |
| 100 | Spike | 00 - 06 | 1 | ● |
| 110 | Spike | 00 - 06 | 1 | ● |
| 125 | Jetix | 08 - | 1 | ● |
| 125 | Nexxon | 07 - | 1 | ● |
| 125 | Spike | 02 - | 1 | ● |
| 150 | Straight | 08 - | 1 | ● |

PEUGEOT

| | | | | |
|----|----------------------------|------|---|---|
| 50 | Speedfight 3 Air cooled | 09 - | 1 | ● |
| 50 | Speedfight 3 Liquid Cooled | 09 - | 1 | ● |
| 50 | Speedfight 3 RS | 09 - | 1 | ● |

SACHS

| | | | | |
|----|-------------------|---------|---|---|
| 50 | Madass (2 stroke) | 04 - 05 | 1 | ● |
| 50 | Madass (4 stroke) | 04 - 05 | 1 | ● |
| 50 | Madass (4T) | 06 - 09 | 1 | ● |

| JONWAY | | | | | |
|--------|-----|----------------------|---------|---|---|
| YY | 50 | QT-10 Viper (2T/4T) | 07 - 09 | 1 | ● |
| YY | 50 | QT-28 Raptor (2T/4T) | 07 - 09 | 1 | ● |
| YY | 50 | QT-6 Agility (2T/4T) | 07 - 09 | 1 | ● |
| YY | 80 | QT-6 Agility (4T) | 07 - 09 | 1 | ● |
| YY | 150 | T-19 | 08 - 09 | 1 | ● |
| YY | 250 | T-19 | 08 - 09 | 1 | ● |

| KEEWAY | | | | | |
|--------|----|--|------|--|---|
| RY8 | 50 | | 10 - | | ● |



Dim./Size

77 mm

42 mm

8 mm

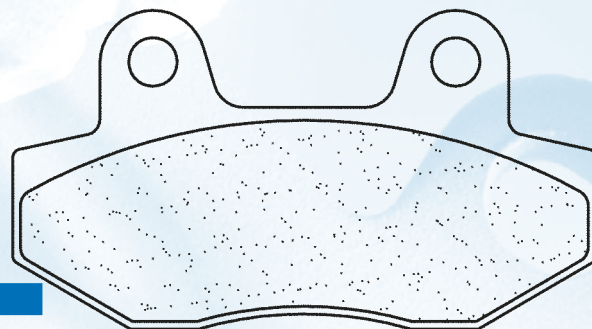
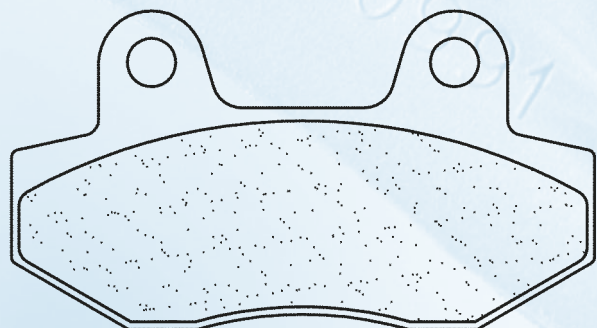

SCOOTER

MAXI-SCOOTER

MSC

YAMAHA

| | | | | | |
|------------|-----|----------------|------|---|---|
| YP | 125 | R X-Max | 10 - | 1 | ● |
| YP | 125 | R X-Max ABS | 11 - | 1 | ● |
| MBK | | | | | |
| | 125 | Skycruiser | 10 - | 1 | ● |
| | 125 | Skycruiser ABS | 11 - | 1 | ● |

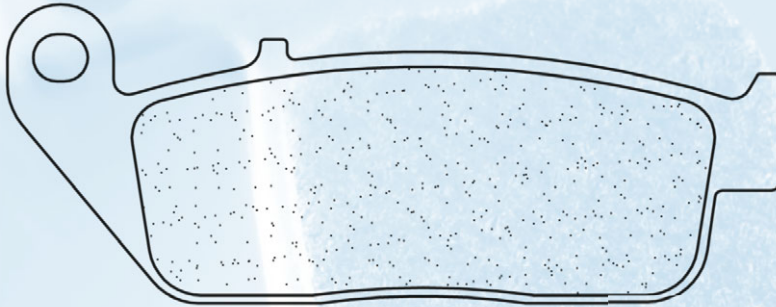

3097

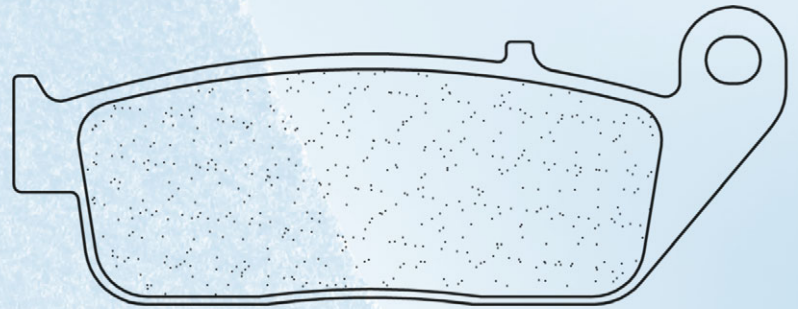

Dim./Size

→ 101,9 mm
↑ 39,2 mm
H 10,5 mm

SCOOTER

MAXI-SCOOTER

MSC

YAMAHA

| | | | | | |
|------------|-----|-------------|------|---|---|
| YW | 125 | Z (BWS 125) | 10 - | 1 | ● |
| MBK | | | | | |
| | 125 | X-Over | 10 - | 1 | ● |

3098

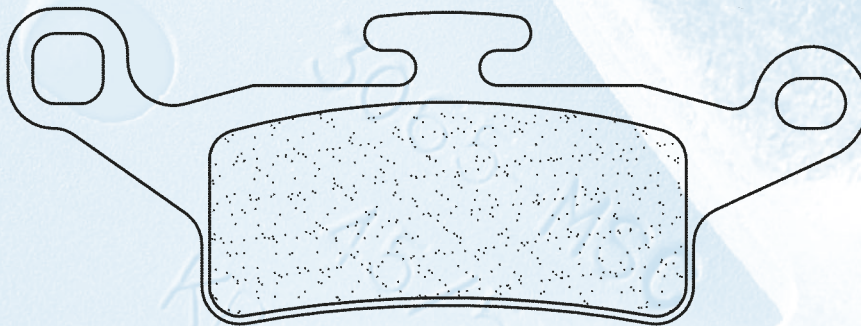

Dim./Size

→ 109,5 mm
↑ 51,1 mm
H 9 mm

Dim./Size

→ 113,6 mm
↑ 41,6 mm
H 9 mm

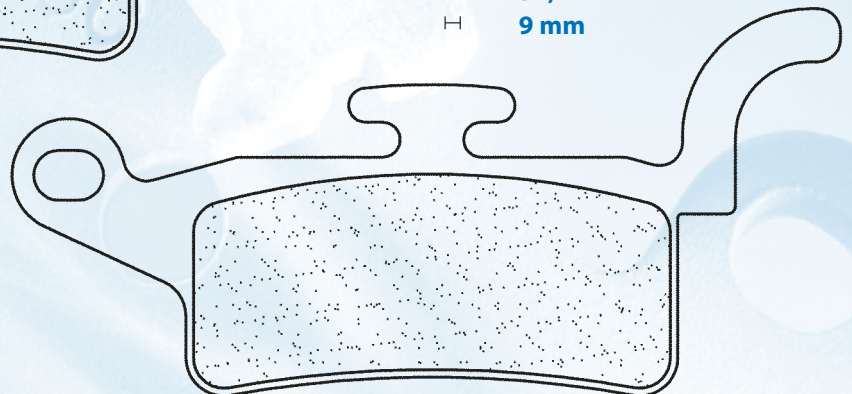

SCOOTER

MAXI-SCOOTER

MSC

YAMAHA

XC 125 Vity 08 - 1 ●

MBK 125 Waap 08 - 1 ●

3099

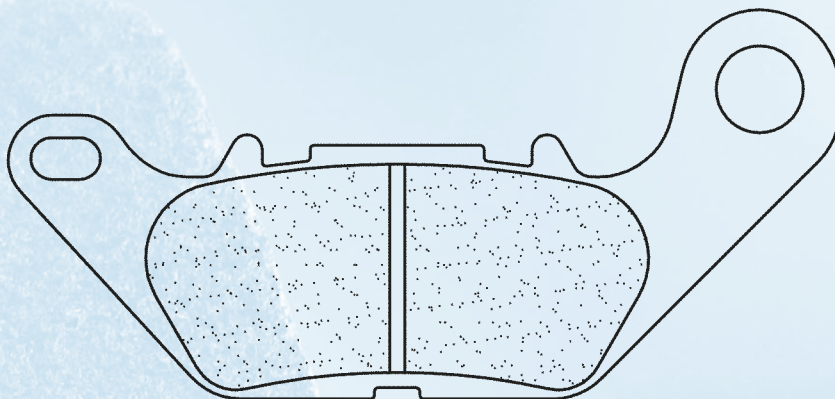

Dim./Size

→ 95,6 mm

↑↓ 37,5 mm

H 8,5 mm

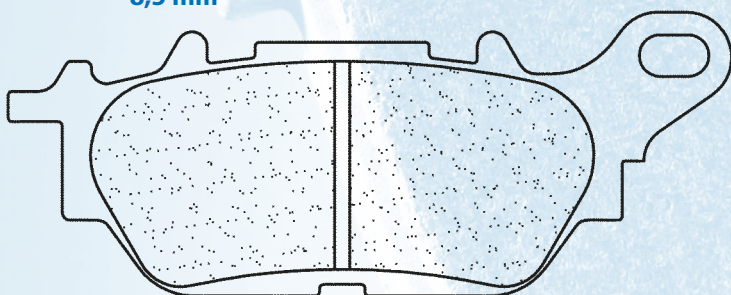

Dim./Size

→ 109,9 mm

↑↓ 51,4 mm

H 8,5 mm

3065 MSC
45/5
KBA60991



Tableau d'équivalences / Interchange list

Austauschliste / Tabella comparativa

Tablero de equivalencia

Street / Off-Road / ATV

| SBS | LCL | SBS | LCL | SBS | LCL | EBC | LCL | EBC | LCL |
|-----|------|-----|------|-----|------|---------|------|---------|------|
| 131 | 2249 | 634 | 2361 | 749 | 1123 | FA016 | 2950 | FA158 | 2251 |
| 137 | 2360 | 635 | 2388 | 750 | 2958 | FA018 | 2332 | FA159 | 2927 |
| 506 | 2332 | 638 | 2326 | 752 | 1034 | FA024/2 | 2599 | FA160 | 2311 |
| 507 | 2847 | 639 | 2361 | 754 | 2923 | FA030 | 2814 | FA162 | 2269 |
| 508 | 2814 | 640 | 2258 | 755 | 2925 | FA031 | 2814 | FA163 | 2400 |
| 513 | 2599 | 641 | 2400 | 758 | 2926 | FA034 | 2847 | FA165 | 2326 |
| 517 | 2814 | 642 | 2927 | 762 | 1033 | FA047 | 1167 | FA167 | 1144 |
| 519 | 2249 | 644 | 2430 | 763 | 1203 | FA047 | 2249 | FA169 | 2696 |
| 533 | 2694 | 645 | 2311 | 765 | 2813 | FA051 | 2694 | FA170 | 2430 |
| 536 | 2408 | 646 | 2249 | 767 | 1102 | FA054 | 2408 | FA171 | 2258 |
| 537 | 2700 | 647 | 2248 | 769 | 1084 | FA060 | 1089 | FA172 | 2360 |
| 541 | 2466 | 650 | 2360 | 770 | 1066 | FA063 | 2282 | FA173 | 2472 |
| 542 | 2289 | 651 | 2472 | 773 | 1223 | FA067 | 2306 | FA174 | 2296 |
| 543 | 2718 | 652 | 1144 | 774 | 1146 | FA067/2 | 2466 | FA179 | 2391 |
| 544 | 2469 | 654 | 2313 | 775 | 1151 | FA069 | 2289 | FA180 | 2363 |
| 546 | 2306 | 657 | 2296 | 777 | 1076 | FA069/2 | 2382 | FA181 | 2352 |
| 547 | 2807 | 658 | 2369 | 778 | 2960 | FA070 | 2807 | FA182 | 2309 |
| 548 | 2469 | 659 | 2269 | 779 | 2404 | FA071 | 2700 | FA183 | 2584 |
| 549 | 2701 | 663 | 2391 | 782 | 1083 | FA072 | 2718 | FA185 | 2300 |
| 550 | 2802 | 665 | 2309 | 783 | 1078 | FA077 | 2840 | FA187 | 2245 |
| 551 | 2621 | 666 | 2363 | 784 | 1067 | FA078 | 2701 | FA188 | 2255 |
| 553 | 2702 | 668 | 2342 | 787 | 1165 | FA079 | 2702 | FA189 | 2257 |
| 554 | 2840 | 669 | 2370 | 788 | 1110 | FA081 | 2802 | FA190 | 2254 |
| 555 | 2283 | 670 | 2408 | 789 | 1145 | FA083 | 2469 | FA191 | 2362 |
| 556 | 2282 | 671 | 2352 | 790 | 1103 | FA083/2 | 2469 | FA192 | 2381 |
| 557 | 2285 | 672 | 2601 | 791 | 1108 | FA084 | 2328 | FA193 | 2307 |
| 558 | 2451 | 674 | 2396 | 794 | 1128 | FA084/2 | 2328 | FA194 | 1146 |
| 559 | 2377 | 675 | 2353 | 796 | 1101 | FA085 | 2285 | FA196 | 2313 |
| 562 | 2328 | 676 | 2899 | 797 | 1148 | FA086 | 2621 | FA197 | 2326 |
| 566 | 2247 | 677 | 2584 | 798 | 1141 | FA088 | 2283 | FA199 | 2546 |
| 570 | 2301 | 680 | 2260 | 801 | 1142 | FA092 | 2451 | FA200 | 2370 |
| 572 | 2382 | 682 | 2362 | 805 | 1075 | FA094 | 2699 | FA201 | 2342 |
| 574 | 1089 | 683 | 2254 | 806 | 1133 | FA095 | 2247 | FA208 | 2353 |
| 575 | 2284 | 684 | 2472 | 807 | 1149 | FA101 | 2284 | FA209 | 2396 |
| 577 | 2280 | 685 | 2257 | 808 | 1150 | FA103 | 2280 | FA210 | 2369 |
| 579 | 2699 | 686 | 2255 | 809 | 1134 | FA104 | 2301 | FA213 | 2353 |
| 580 | 2792 | 687 | 2381 | 810 | 1147 | FA105 | 2792 | FA215 | 2288 |
| 581 | 2387 | 688 | 2326 | 813 | 1140 | FA106 | 2387 | FA215/2 | 2326 |
| 582 | 2386 | 691 | 2546 | 814 | 2621 | FA106/2 | 2386 | FA218 | 2329 |
| 584 | 2328 | 692 | 2306 | 816 | 1102 | FA107 | 2799 | FA220 | 2361 |
| 586 | 2306 | 694 | 2300 | 820 | 1152 | FA113 | 2794 | FA222 | 2390 |
| 588 | 2794 | 695 | 2329 | 822 | 1171 | FA115 | 2377 | FA228 | 2288 |
| 589 | 2424 | 697 | 2307 | 824 | 1167 | FA116 | 2260 | FA229 | 2383 |
| 590 | 2305 | 698 | 2950 | 828 | 1159 | FA118 | 2393 | FA230 | 2914 |
| 591 | 2799 | 700 | 2313 | 830 | 1172 | FA119 | 2424 | FA231 | 2384 |
| 592 | 2328 | 701 | 2390 | 833 | 1163 | FA120 | 2801 | FA232 | 2924 |
| 593 | 2252 | 702 | 2914 | 834 | 1174 | FA121 | 2252 | FA236 | 2246 |
| 594 | 2801 | 703 | 2430 | 836 | 1102 | FA123 | 2253 | FA244 | 2539 |
| 596 | 2393 | 704 | 2384 | 838 | 1177 | FA123 | 2305 | FA246 | 2430 |
| 597 | 2304 | 705 | 2383 | 839 | 1180 | FA124 | 2310 | FA249 | 2404 |
| 600 | 2310 | 706 | 2539 | 840 | 1183 | FA125 | 2302 | FA249 | 2404 |
| 601 | 2398 | 707 | 2720 | 841 | 1185 | FA126 | 2398 | FA249 | 2899 |
| 603 | 2302 | 709 | 1164 | 843 | 1129 | FA128 | 2799 | FA252 | 2361 |
| 604 | 2314 | 713 | 2288 | 844 | 1187 | FA129 | 2304 | FA254 | 2813 |
| 608 | 2400 | 714 | 2961 | 846 | 1211 | FA131 | 2314 | FA257 | 2408 |
| 611 | 2288 | 715 | 2813 | 847 | 1184 | FA132 | 2399 | FA258 | 2750 |
| 613 | 2253 | 716 | 2927 | 849 | 1192 | FA134 | 2400 | FA261 | 2602 |
| 614 | 2298 | 717 | 2924 | 850 | 1193 | FA135 | 2288 | FA263 | 2720 |
| 615 | 2389 | 719 | 2922 | 851 | 1194 | FA136 | 2392 | FA265 | 2711 |
| 616 | 2392 | 722 | 2602 | 852 | 1195 | FA137 | 2328 | FA266 | 2827 |
| 618 | 2287 | 726 | 2750 | 853 | 1212 | FA140 | 2298 | FA267 | 2713 |
| 619 | 2696 | 728 | 2828 | 854 | 1213 | FA141 | 2389 | FA270R | 2925 |
| 620 | 2281 | 729 | 2404 | 858 | 1224 | FA142 | 2256 | FA271R | 2926 |
| 621 | 2399 | 730 | 2827 | 860 | 2711 | FA142/2 | 2248 | FA272 | 2922 |
| 622 | 2245 | 733 | 2713 | 862 | 1217 | FA143 | 2385 | FA275 | 2828 |
| 623 | 2385 | 734 | 2711 | 864 | 1209 | FA145 | 2246 | FA283 | 1175 |
| 624 | 2246 | 735 | 2602 | 866 | 1204 | FA145 | 2961 | FA294 | 2960 |
| 626 | 2308 | 735 | 2923 | 867 | 1205 | FA146 | 2281 | FA299 | 2958 |
| 627 | 2256 | 736 | 2602 | 869 | 1216 | FA147 | 2308 | FA302 | 1034 |
| 630 | 2313 | 737 | 2249 | 870 | 1207 | FA151 | 2287 | FA304 | 2987 |
| 631 | 2251 | 740 | 1175 | 872 | 1219 | FA152 | 2299 | FA305 | 1123 |
| 632 | 2299 | 742 | 2900 | 895 | 1139 | FA156 | 2601 | FA307 | 2923 |
| 633 | 2326 | 746 | 2987 | | | FA157 | 2388 | FA313/R | 1165 |

Tableau d'équivalences / Interchange list

Austauschliste / Tabella comparativa

Tablero de equivalencia

Street / Off-Road / ATV

| EBC | LCL | Ferodo | LCL | Ferodo | LCL | Ferodo | LCL |
|---------|------|---------|------|----------|------|----------|------|
| FA317 | 1102 | FDB 108 | 2332 | FDB 866 | 2601 | FDB 2196 | 1159 |
| FA319/2 | 1084 | FDB 185 | 2599 | FDB 873 | 2255 | FDB 2197 | 1152 |
| FA320 | 1203 | FDB 204 | 2840 | FDB 892 | 2300 | FDB 2203 | 1110 |
| FA322 | 1033 | FDB 207 | 2249 | FDB 2002 | 2257 | FDB 2204 | 1133 |
| FA323 | 1164 | FDB 244 | 2289 | FDB 2003 | 2546 | FDB 2205 | 1134 |
| FA325R | 1128 | FDB 250 | 2408 | FDB 2005 | 2353 | FDB 2206 | 1103 |
| FA335 | 1101 | FDB 312 | 2621 | FDB 2007 | 2329 | FDB 2210 | 1172 |
| FA342 | 1142 | FDB 313 | 2469 | FDB 2012 | 2381 | FDB 2213 | 1163 |
| FA343 | 1067 | FDB 314 | 2306 | FDB 2015 | 2424 | FDB 2216 | 1187 |
| FA345 | 1139 | FDB 333 | 2700 | FDB 2018 | 2352 | FDB 2216 | 1187 |
| FA346 | 1076 | FDB 334 | 2718 | FDB 2018 | 2396 | FDB 2217 | 1180 |
| FA347 | 1083 | FDB 335 | 2701 | FDB 2022 | 2313 | FDB 2218 | 1185 |
| FA348 | 1066 | FDB 337 | 2283 | FDB 2036 | 2899 | FDB 2219 | 1183 |
| FA349 | 1141 | FDB 338 | 2282 | FDB 2036 | 2404 | FDB 2220 | 1177 |
| FA350 | 1223 | FDB 339 | 2285 | FDB 2042 | 2539 | FDB 2221 | 1174 |
| FA355 | 1151 | FDB 352 | 2699 | FDB 2043 | 2720 | FRP 213 | 2950 |
| FA357 | 1078 | FDB 381 | 2328 | FDB 2044 | 2799 | FRP 405 | 2377 |
| FA363 | 2900 | FDB 382 | 1164 | FDB 2048 | 2384 | FRP 408 | 2247 |
| FA366 | 1145 | FDB 382 | 2451 | FDB 2049 | 2383 | FRP 417 | 2584 |
| FA367 | 1103 | FDB 383 | 2284 | FDB 2050 | 2430 | | |
| FA368 | 1108 | FDB 386 | 2301 | FDB 2054 | 2924 | | |
| FA369 | 1110 | FDB 404 | 2387 | FDB 2055 | 2927 | | |
| FA375 | 1148 | FDB 411 | 2792 | FDB 2058 | 2390 | | |
| FA377 | 1147 | FDB 438 | 2794 | FDB 2073 | 2602 | | |
| FA379 | 1133 | FDB 449 | 2305 | FDB 2074 | 2827 | | |
| FA380 | 2361 | FDB 449 | 2311 | FDB 2075 | 2602 | | |
| FA381 | 1149 | FDB 452 | 2310 | FDB 2079 | 2711 | | |
| FA387 | 1150 | FDB 462 | 2252 | FDB 2080 | 2750 | | |
| FA388 | 1159 | FDB 481 | 2304 | FDB 2080 | 1141 | | |
| FA390 | 1134 | FDB 485 | 2342 | FDB 2083 | 2828 | | |
| FA395 | 1171 | FDB 495 | 2302 | FDB 2084 | 2711 | | |
| FA400 | 1211 | FDB 496 | 2385 | FDB 2085 | 1175 | | |
| FA400 | 2958 | FDB 497 | 2288 | FDB 2097 | 2958 | | |
| FA401 | 1152 | FDB 498 | 2398 | FDB 2098 | 2602 | | |
| FA409 | 1172 | FDB 499 | 2400 | FDB 2099 | 2539 | | |
| FA413 | 2923 | FDB 508 | 2389 | FDB 2102 | 2987 | | |
| FA417 | 1177 | FDB 531 | 2298 | FDB 2106 | 1146 | | |
| FA419 | 1163 | FDB 533 | 2245 | FDB 2110 | 1034 | | |
| FA424 | 2899 | FDB 538 | 2382 | FDB 2111 | 2813 | | |
| FA427 | 1184 | FDB 539 | 2314 | FDB 2113 | 2252 | | |
| FA432 | 1187 | FDB 557 | 2961 | FDB 2114 | 2711 | | |
| FA433 | 1129 | FDB 557 | 2246 | FDB 2120 | 1033 | | |
| FA435 | 1075 | FDB 561 | 2399 | FDB 2121 | 2925 | | |
| FA436 | 1174 | FDB 569 | 2281 | FDB 2124 | 2960 | | |
| FA442 | 1180 | FDB 570 | 2256 | FDB 2125 | 1101 | | |
| FA443 | 1192 | FDB 574 | 2251 | FDB 2131 | 2313 | | |
| FA443 | 1195 | FDB 583 | 2393 | FDB 2133 | 2914 | | |
| FA444 | 1193 | FDB 591 | 2392 | FDB 2139 | 1076 | | |
| FA444 | 1194 | FDB 605 | 2361 | FDB 2141 | 1151 | | |
| FA447 | 1185 | FDB 606 | 2308 | FDB 2143 | 1067 | | |
| FA450 | 1183 | FDB 607 | 2388 | FDB 2144 | 2255 | | |
| FA456R | 1220 | FDB 636 | 2696 | FDB 2145 | 1139 | | |
| FA457 | 1212 | FDB 657 | 2430 | FDB 2148 | 2923 | | |
| FA458 | 1213 | FDB 659 | 2299 | FDB 2149 | 1102 | | |
| FA462R | 1204 | FDB 662 | 2253 | FDB 2150 | 1066 | | |
| FA464 | 1224 | FDB 663 | 2248 | FDB 2156 | 1084 | | |
| FA475 | 1222 | FDB 673 | 2386 | FDB 2157 | 1078 | | |
| FA488 | 1217 | FDB 680 | 1167 | FDB 2158 | 1083 | | |
| FA499/4 | 1216 | FDB 680 | 2307 | FDB 2162 | 1103 | | |
| | | FDB 694 | 1089 | FDB 2163 | 1145 | | |
| | | FDB 697 | 2260 | FDB 2164 | 1110 | | |
| | | FDB 706 | 1144 | FDB 2165 | 1108 | | |
| | | FDB 731 | 2466 | FDB 2167 | 2720 | | |
| | | FDB 736 | 2258 | FDB 2169 | 1148 | | |
| | | FDB 737 | 2360 | FDB 2178 | 1133 | | |
| | | FDB 741 | 2363 | FDB 2179 | 1149 | | |
| | | FDB 754 | 2296 | FDB 2180 | 1150 | | |
| | | FDB 781 | 2391 | FDB 2181 | 1134 | | |
| | | FDB 828 | 2472 | FDB 2182 | 1140 | | |
| | | FDB 847 | 2369 | FDB 2183 | 1128 | | |
| | | FDB 858 | 1157 | FDB 2184 | 1147 | | |
| | | FDB 864 | 2254 | FDB 2188 | 1142 | | |
| | | FDB 865 | 2362 | FDB 2194 | 2269 | | |

Tableau d'équivalences / Interchange list

Austauschliste / Tabella comparativa

Tablero de equivalencia

Scooter / Maxi-Scooter

| SBS | LCL | SBS | LCL | EBC | LCL | EBC | LCL | Ferodo | LCL | Ferodo | LCL |
|-----|------|-----|------|----------|------|--------|------|----------|------|----------|------|
| 100 | 3018 | 183 | 3003 | FA 047 | 3001 | FA 393 | 3069 | FDB 244 | 3011 | FDB 2207 | 3084 |
| 101 | 3022 | 183 | 3065 | FA 054 | 3018 | FA 396 | 3051 | FDB 250 | 3018 | FDB 2208 | 3085 |
| 102 | 3022 | 184 | 3059 | FA 060 | 3037 | FA 408 | 3075 | FDB 312 | 3096 | FDB 2211 | 3082 |
| 104 | 3019 | 185 | 3075 | FA 067/2 | 3024 | FA 411 | 3074 | FDB 313 | 3022 | FDB 2212 | 3083 |
| 105 | 3015 | 186 | 3069 | FA 069 | 3011 | FA 412 | 3066 | FDB 382 | 3019 | FDB 2226 | 3089 |
| 106 | 3037 | 187 | 3077 | FA 069/2 | 3017 | FA 415 | 3083 | FDB 383 | 3008 | FDB 2226 | 3092 |
| 107 | 3008 | 190 | 3069 | FA 083 | 3022 | FA 418 | 3077 | FDB 436 | 3034 | FRP 405 | 3015 |
| 108 | 3021 | 191 | 3084 | FA 086 | 3096 | FA 425 | 3084 | FDB 452 | 3066 | | |
| 109 | 3004 | 192 | 3082 | FA 092 | 3019 | FA 427 | 3089 | FDB 497 | 3078 | | |
| 110 | 3009 | 193 | 3083 | FA 092 | 3074 | FA 427 | 3092 | FDB 497 | 3087 | | |
| 111 | 3029 | 194 | 3085 | FA 093 | 3012 | FA 430 | 3085 | FDB 531 | 3076 | | |
| 113 | 3024 | 195 | 3089 | FA 099 | 3034 | FA 464 | 3099 | FDB 538 | 3017 | | |
| 114 | 3013 | 196 | 3090 | FA 101 | 3008 | FA 492 | 3098 | FDB 570 | 3003 | | |
| 115 | 3038 | 197 | 3087 | FA 115 | 3015 | FA 498 | 3094 | FDB 605 | 3091 | | |
| 116 | 3006 | 198 | 3091 | FA 116 | 3004 | | | FDB 625 | 3038 | | |
| 117 | 3053 | 200 | 3096 | FA 124 | 3066 | | | FDB 631 | 3036 | | |
| 118 | 3012 | 201 | 3092 | FA 131/2 | 3006 | | | FDB 636 | 3029 | | |
| 118 | 3024 | 202 | 3043 | FA 131/3 | 3014 | | | FDB 672 | 3014 | | |
| 119 | 3062 | 204 | 3094 | FA 140 | 3076 | | | FDB 677 | 3031 | | |
| 120 | 3031 | 208 | 3098 | FA 142 | 3003 | | | FDB 680 | 3013 | | |
| 121 | 3014 | 595 | 3034 | FA 142 | 3065 | | | FDB 694 | 3037 | | |
| 122 | 3051 | 713 | 3087 | FA 151 | 3009 | | | FDB 697 | 3004 | | |
| 123 | 3013 | 723 | 3047 | FA 165 | 3036 | | | FDB 706 | 3069 | | |
| 124 | 3020 | 858 | 3099 | FA 167 | 3069 | | | FDB 731 | 3024 | | |
| 125 | 3073 | | | FA 169 | 3029 | | | FDB 781 | 3058 | | |
| 127 | 3017 | | | FA 173 | 3012 | | | FDB 783 | 3006 | | |
| 128 | 3025 | | | FA 178 | 3038 | | | FDB 828 | 3012 | | |
| 129 | 3041 | | | FA 179 | 3058 | | | FDB 851 | 3065 | | |
| 130 | 3045 | | | FA 181 | 3028 | | | FDB 2003 | 3025 | | |
| 132 | 3034 | | | FA 186 | 3053 | | | FDB 2018 | 3028 | | |
| 134 | 3036 | | | FA 193 | 3013 | | | FDB 2037 | 3045 | | |
| 134 | 3086 | | | FA 194 | 3031 | | | FDB 2056 | 3043 | | |
| 135 | 3012 | | | FA 196 | 3059 | | | FDB 2060 | 3020 | | |
| 138 | 3001 | | | FA 197 | 3062 | | | FDB 2060 | 3021 | | |
| 140 | 3039 | | | FA 197 | 3086 | | | FDB 2062 | 3027 | | |
| 141 | 3047 | | | FA 199 | 3025 | | | FDB 2073 | 3026 | | |
| 142 | 3043 | | | FA 206 | 3013 | | | FDB 2074 | 3057 | | |
| 143 | 3013 | | | FA 228 | 3078 | | | FDB 2081 | 3001 | | |
| 144 | 3014 | | | FA 228 | 3087 | | | FDB 2083 | 3033 | | |
| 145 | 3027 | | | FA 230 | 3051 | | | FDB 2085 | 3049 | | |
| 146 | 3049 | | | FA 234 | 3041 | | | FDB 2086 | 3074 | | |
| 147 | 3026 | | | FA 235 | 3047 | | | FDB 2087 | 3062 | | |
| 148 | 3069 | | | FA 252 | 3091 | | | FDB 2087 | 3086 | | |
| 149 | 3013 | | | FA 255 | 3043 | | | FDB 2090 | 3055 | | |
| 151 | 3028 | | | FA 255 | 3045 | | | FDB 2095 | 3064 | | |
| 152 | 3055 | | | FA 256 | 3020 | | | FDB 2096 | 3068 | | |
| 153 | 3064 | | | FA 256 | 3072 | | | FDB 2100 | 3053 | | |
| 154 | 3068 | | | FA 257 | 3038 | | | FDB 2101 | 3041 | | |
| 155 | 3033 | | | FA 260 | 3043 | | | FDB 2105 | 3056 | | |
| 155 | 3095 | | | FA 261 | 3026 | | | FDB 2106 | 3031 | | |
| 156 | 3026 | | | FA 264 | 3039 | | | FDB 2108 | 3067 | | |
| 157 | 3057 | | | FA 266 | 3057 | | | FDB 2115 | 3054 | | |
| 158 | 3079 | | | FA 268 | 3027 | | | FDB 2119 | 3073 | | |
| 159 | 3056 | | | FA 275 | 3033 | | | FDB 2126 | 3061 | | |
| 160 | 3011 | | | FA 283 | 3049 | | | FDB 2128 | 3063 | | |
| 161 | 3076 | | | FA 298 | 3055 | | | FDB 2130 | 3079 | | |
| 163 | 3078 | | | FA 301 | 3064 | | | FDB 2131 | 3059 | | |
| 164 | 3013 | | | FA 305 | 3068 | | | FDB 2132 | 3074 | | |
| 166 | 3054 | | | FA 306 | 3067 | | | FDB 2133 | 3051 | | |
| 167 | 3063 | | | FA 307 | 3090 | | | FDB 2140 | 3071 | | |
| 168 | 3031 | | | FA 319 | 3061 | | | FDB 2141 | 3070 | | |
| 169 | 3061 | | | FA 321 | 3054 | | | FDB 2142 | 3060 | | |
| 170 | 3058 | | | FA 323/3 | 3073 | | | FDB 2146 | 3072 | | |
| 171 | 3070 | | | FA 324 | 3056 | | | FDB 2147 | 3081 | | |
| 172 | 3071 | | | FA 350 | 3063 | | | FDB 2148 | 3090 | | |
| 173 | 3081 | | | FA 353 | 3060 | | | FDB 2169 | 3080 | | |
| 174 | 3074 | | | FA 355 | 3070 | | | FDB 2173 | 3066 | | |
| 177 | 3060 | | | FA 356 | 3071 | | | FDB 2186 | 3077 | | |
| 178 | 3067 | | | FA 357 | 3070 | | | FDB 2187 | 3003 | | |
| 179 | 3072 | | | FA 358 | 3079 | | | FDB 2190 | 3039 | | |
| 180 | 3080 | | | FA 374 | 3081 | | | FDB 2191 | 3047 | | |
| 181 | 3097 | | | FA 375 | 3080 | | | FDB 2192 | 3009 | | |
| 182 | 3066 | | | FA 388 | 3082 | | | FDB 2200 | 3075 | | |

Matériaux de friction série C685 Nuances

Sintered Friction materials C685 Grade

Gesinterte Reibungswerkstoffe

Materiali d'attrito serie C685. Mescole

Materialies de fricción Serie C685 garnitures

S4, A3+, RX3, XBK5, C59, MX10, EN10, X59, ATV1, SC, MSC

Description

Matériau de friction métallique fritté, base bronze ; nickel, plomb et amiante sont exclus de la composition.

Application

Freinage sur disque acier d'origine pour motos, quad et scooter (disques fontes et Supersport : consulter votre revendeur).

Avantages

Matériau à usure particulièrement réduite sans dommage particulier pour le disque. Coefficient de frottement élevé et stable à froid, à chaud par temps sec ou pluie.

Freinage instantané lié à une puissance élevée de freinage garantissant des distances d'arrêt minimum.

Recommandations

Rodage : freinage modéré sur les 300 premiers kilomètres. En conditions de freinage extrêmement sévères et répétitives, nécessité d'utiliser un étrier et un liquide hydraulique adaptés.

Freinage sur disque fonte, compétition ou de provenance incertaine : consulter votre revendeur.

Composition

Sintered metallic material, bronze based (nickel, lead and asbestos are excluded from the composition).

Application

Braking on original motorcycles, ATV and scooter steel disc equipment (cast iron disc and Supersport : ask your dealer).

Advantages

Grade C685 provides instant and powerful braking without high wear nor damage on the disc. Very efficient whatever the conditions : hot or cold disc, dry or rainy weather... Thanks to high coefficient of friction. Consistency and high power capabilities allow the shortest stopping distances.

A few tips... Proceed to smooth or moderate braking until 60 % of the pad area is in contact during the running in period. Frequent and severe braking will generate high temperature on the caliper. Appropriate caliper and hydraulic fluid are required for such conditions. For cast iron disc, racing, or unknown disc, ask your dealer.

Zusammensetzung:

Gesinterte Metallwerkstoffe auf Bronzebasis: nickel- blei- und asbestfrei.

Anwendungsbereich

Bremsbeläge für Stahlbrems scheiben von Motorrädern in originalausstattung.

Composizione della mescola

Materiale d'attrito metallico sinterizzato a base di bronzo; nichel, piombo e amianto sono esclusi dal composto.

Applicazione

I nostri materiali d'attrito sono concepiti per frenata su disco in acciaio originale per moto, quad e scooter (per i dischi in ghisa e Supersport: consultare il vostro rivenditore).

Frenata istantanea a potenza elevata che garantisce una distanza di frenata minima.

Raccomandazioni

Rodaggio: si raccomanda una frenata moderata per i primi 300 km. In condizioni di frenata severa e ripetitiva, si rende necessario l'utilizzo di una pinza e un liquido freni adatti.

Frenata su disco in ghisa: consultate il vostro rivenditore.

Descripción

Material de fricción metálico sinterizado, a base de bronce, sin plomo, sin amianto ni nickel.

Aplicación

Frenado sobre disco acero de origen para las motocicletas, ATV y scooter (Discos de hierro fundido y super deportivo : consulte su revendedor).

Ventajas

Material con usura muy reducida sin daño del disco. Coeficiente de fricción elevado e estable en todo tipo de tiempo y a cualquiera temperatura de las pastillas (frías o caldas).

Frenado instantaneo en relación con una potencia elevada de frenado que garantiza distancias de parada mínima.

Recomendaciones

Rodaje :frenado moderado sobre los 300 primeros kilómetros. En condiciones de frenados extremos y repetitivos, es necesario usar una pinza de freno y un liquido hidráulico adaptables.

Garanties

Warranty

Garantie

Garanzie

Garantías

Garanties

Warranty

Garantie

Garanzie

Garantías

FAIVELEY TRANSPORT GENNEVILLIERS garantit ses produits contre tous vices (matériaux et exécution). Toute application de la garantie, qu'il s'agisse de la garantie indiquée ci-avant ou de toute autre garantie implicite est strictement limitée à la seule réparation ou au seul remplacement des parties défectueuses.

Toutes les informations figurant sur le présent document résultent d'essais faits dans des conditions de laboratoire et sont données à titre indicatif.

FAIVELEY TRANSPORT GENNEVILLIERS n'assure aucune responsabilité quant aux conséquences de l'utilisation de ces informations à quelques fins que ce soit. Toute copie, reproduction ou traduction de ces informations, intégralement ou partiellement, sans accord écrit de FAIVELEY TRANSPORT GENNEVILLIERS, est interdite conformément aux dispositions de la loi n°92-597 du 1^{er} juillet 1992

FAIVELEY TRANSPORT GENNEVILLIERS warrants and undertakes that it will replace or repair any defective material or workmanship, and which, under proper use, appears in its products. The express warranties set forth herein shall constitute the sole and exclusive warranties and guarantees made by the vendor. Accordingly the remedies for any failure by FAIVELEY TRANSPORT GENNEVILLIERS to comply with its said warranties and are exclusive and in lieu of all other remedies of any kind.

The information presented herein is based exclusively on lab tests considered to be accurate at the date of preparation of this brochure.

However no warranty or representation expressed implied is made as to the accuracy of the forgoing data. In addition no responsibility can be assumed by FAIVELEY TRANSPORT GENNEVILLIERS.

Im Fall von material- oder Herstellungsfehlern, die bei ordnungsgemäßen Gebrauch der Produkte auftreten, verpflichtet sich der FAIVELEY TRANSPORT GENNEVILLIERS zum Ersatz oder zur Reparatur des betroffenen Produktes.

Die FAIVELEY TRANSPORT GENNEVILLIERS garantie beschränkt sich auf die ausdrücklich im vorliegenden Dokument festgesetzte Garantie. Infolgedessen stellen die hierin festgelegten Garantiemaßnahmen die einzigen Maßnahmen dar, die vom FAIVELEY TRANSPORT GENNEVILLIERS für jegliche Defekte im Hinblick auf die Erfüllung der Garantie durchzuführen sind, und ersetzen sämtliche andere mögliche Abhilfemaßnahmen.

Die in der vorliegenden Broschüre enthaltenen Informationen stützen sich ausschließlich auf die bei Redaktionsschluß als für gültig erachtete Laboruntersuchungen. Dennoch verstehen sich die vorstehenden Angaben im Hinblick auf ihre Richtigkeit und Vollständigkeit ohne Gewähr. Darüber hinaus übernimmt der Carbone lorraine composants keinerlei Garantie für Schäden, Verletzungen oder Ausfälle, die auf einen nicht ordnungsgemäßen Gebrauch der Produkte oder auf mit deren Gebrauch verbundene Risiken zurückzuführen sind.

FAIVELEY TRANSPORT GENNEVILLIERS garantisce i suoi prodotti contro tutti i difetti di materiale e di fabbricazione. L'applicazione di tale garanzia o di qualsiasi altra garanzia implicite è strettamente limitata alla sola riparazione o sostituzione delle parti difettose.

Tutte le informazioni presenti su questo catalogo sono il risultato di test di laboratorio e sono pertanto puramente indicative.

FAIVELEY TRANSPORT GENNEVILLIERS non si assume responsabilità per le conseguenze dell'utilizzo di queste informazioni a qualsiasi titolo o scopo. La copia, riproduzione o la traduzione di queste informazioni, integrale o parziale, senza accordo scritto da parte di Faiveley, è vietata.

FAIVELEY TRANSPORT GENNEVILLIERS garantiza sus productos contra todos defectos (material y fabricación) Toda aplicación de la garantía que sea la garantía indicada arriba o toda otra garantía implícita, se limita a la reparación o a la sustitución de las partes defectuosas.

Todas las informaciones que están en este documento resultan de pruebas realizadas en laboratorio y están dadas a título indicativo. FAIVELEY TRANSPORT GENNEVILLIERS no asegura ninguna responsabilidad en lo que concierne las consecuencias del uso de estas informaciones a cualquier fin que sea.

Toda copia, reproducción o traducción de estas informaciones, sin acuerdo escrito de FAIVELEY TRANSPORT GENNEVILLIERS, esta prohibida.



BRAKES

HIGH PERFORMANCE
SINTERED
BRAKE PADS

FAIVELEY TRANSPORT GENNEVILLIERS

41 rue Jean Jaurès

BP 102

92232 GENNEVILLIERS CEDEX

FRANCE

Tél. : + 33 1 41 85 44 92

Fax : + 33 1 41 85 44 91

R.C.S Bobigny 501 996 078



www.cl-brakes.com